

Nikon

DIGITAL CAMERA

COOLPIX S570

User's Manual



En

Trademark Information

- Microsoft, Windows and Windows Vista are either registered trademarks or trademarks of Microsoft Corporation in the United States and/or other countries.
- Macintosh, Mac OS, and QuickTime are trademarks of Apple Inc.
- Adobe and Acrobat are registered trademarks of Adobe Systems Inc.
- The SD logo is a trademark of the SD Card Association.
- PictBridge is a trademark.
- All other trade names mentioned in this manual or the other documentation provided with your Nikon product are trademarks or registered trademarks of their respective holders.

Introduction

First Steps



Basic Photography and Playback: Auto Mode



Shooting Suited for the Scene



Taking Pictures of Smiling Faces (Smart Portrait Mode)



More on Playback/In-Camera Editing



Movies

Connecting to Televisions, Computers and Printers

MENU

Shooting, Playback and Setup Menus

Technical Notes

For Your Safety

To prevent damage to your Nikon product or injury to yourself or to others, read the following safety precautions in their entirety before using this equipment. Keep these safety instructions where all those who use the product will read them. The consequences that could result from failure to observe the precautions listed in this section are indicated by the following symbol:



This icon marks warnings, information that should be read before using this Nikon product, to prevent possible injury.

WARNINGS

Turn off in the event of malfunction

Should you notice smoke or an unusual smell coming from the camera or AC adapter, unplug the AC adapter and remove the battery immediately, taking care to avoid burns. Continued operation could result in injury. After removing or disconnecting the power source, take the equipment to a Nikon-authorized service representative for inspection.

Do not disassemble

Touching the internal parts of the camera or AC adapter could result in injury. Repairs should be performed only by qualified technicians. Should the camera or AC adapter break open as the result of a fall or other accident, take the product to a Nikon-authorized service representative for inspection, after unplugging the product and/or removing the battery.

Do not use the camera or AC adapter in the presence of flammable gas

Do not use electronic equipment in the presence of flammable gas, as this could result in explosion or fire.

Handle the camera strap with care

Never place the strap around the neck of an infant or child.

Keep out of reach of children

Particular care should be taken to prevent infants from putting the battery or other small parts into their mouths.

 Observe caution when handling the battery

The battery may leak or explode if improperly handled. Observe the following precautions when handling the battery for use in this product:

- Before replacing the battery, turn the product off. If you are using the AC adapter, be sure it is unplugged.
- Only use a Rechargeable Li-ion Battery EN-EL10 (supplied). Charge the battery by inserting it in a Battery Charger MH-63 (supplied).
- When inserting the battery, do not attempt to insert it upside down or backwards.
- Do not short or disassemble the battery or attempt to remove or break the battery insulation or casing.
- Do not expose the battery to flame or to excessive heat.
- Do not immerse in or expose to water.
- Return the battery to the battery case for transportation. Do not transport or store with metal objects such as necklaces or hairpins.
- The battery is prone to leakage when fully discharged. To avoid damage to the product, be sure to remove the battery when no charge remains.
- Discontinue use immediately should you notice any change in the battery, such as discoloration or deformation.
- If liquid from the damaged battery comes in contact with clothing or skin, rinse immediately with plenty of water.

 Observe the following precautions when handling the battery charger

- Keep dry. Failure to observe this precaution could result in fire or electric shock.
- Dust on or near the metal parts of the plug should be removed with a dry cloth. Continued use could result in fire.
- Do not handle the power cable or go near the battery charger during lightning storms. Failure to observe this precaution could result in electric shock.
- Do not damage, modify, forcibly tug or bend the power cable, place it under heavy objects, or expose it to heat or flames. Should the insulation be damaged and the wires become exposed, take it to a Nikon-authorized service representative for inspection. Failure to observe these precautions could result in fire or electric shock.
- Do not handle the plug or battery charger with wet hands. Failure to observe this precaution could result in electric shock.
- Do not use with travel converters or adapters designed to convert from one voltage to another or with DC-to-AC inverters. Failure to observe this precaution could damage the product or cause overheating or fire.

 **Use appropriate cables**

When connecting cables to the input and output jacks, use only the cables provided or sold by Nikon for the purpose, to maintain compliance with product regulations.

 **Handle moving parts with care**

Be careful that your fingers or other objects are not pinched by the lens cover or other moving parts.

 **CD-ROMs**

The CD-ROMs supplied with this device should not be played back on audio CD equipment. Playing CD-ROMs on an audio CD player could cause hearing loss or damage the equipment.

 **Observe caution when using the flash**

Using the flash close to your subject's eyes could cause temporary visual impairment. Particular care should be observed if photographing infants, when the flash should be no less than one meter (3 ft. 4 in.) from the subject.

 **Do not operate the flash with the flash window touching a person or object**

Failure to observe this precaution could result in burns or fire.

 **Avoid contact with liquid crystal**

Should the monitor break, care should be taken to avoid injury caused by broken glass and to prevent liquid crystal from the monitor touching the skin or entering the eyes or mouth.

 **Turn the power off when using inside an airplane or the hospital**

Turn the power off while inside the airplane during take off or landing. Follow the instructions of the hospital when using while in a hospital. The electromagnetic waves given out by this camera may disrupt the electronic systems of the airplane or the instruments of the hospital.

Notices

Notice for Customers in the U.S.A.

Federal Communications Commission (FCC) Radio Frequency Interference Statement

This equipment has been tested and found to comply with the limits for a Class B digital device, pursuant to Part 15 of the FCC rules. These limits are designed to provide reasonable protection against harmful interference in a residential installation. This equipment generates, uses, and can radiate radio frequency energy and, if not installed and used in accordance with the instructions, may cause harmful interference to radio communications. However, there is no guarantee that interference will not occur in a particular installation. If this equipment does cause harmful interference to radio or television reception, which can be determined by turning the equipment off and on, the user is encouraged to try to correct the interference by one or more of the following measures:

- Reorient or relocate the receiving antenna.
- Increase the separation between the equipment and receiver.
- Connect the equipment into an outlet on a circuit different from that to which the receiver is connected.
- Consult the dealer or an experienced radio/television technician for help.



Nikon
COOLPIX S570

CAUTIONS

Modifications

The FCC requires the user to be notified that any changes or modifications made to this device that are not expressly approved by Nikon Corporation may void the user's authority to operate the equipment.

Interface Cables

Use the interface cables sold or provided by Nikon for your equipment. Using other interface cables may exceed the limits of Class B Part 15 of the FCC rules.

Notice for customers in the State of California

WARNING

Handling the cord on this product will expose you to lead, a chemical known to the State of California to cause birth defects or other reproductive harm.

Wash hands after handling.

Nikon Inc.,
1300 Walt Whitman Road
Melville, New York 11747-3064
USA
Tel: 631-547-4200

Notice for customers in Canada

CAUTION

This Class B digital apparatus complies with Canadian ICES-003.

ATTENTION

Cet appareil numérique de la classe B est conforme à la norme NMB-003 du Canada.

Notice for customers in Europe

This symbol indicates that this product is to be collected separately.



The following apply only to users in European countries:

- This product is designated for separate collection at an appropriate collection point. Do not dispose of as household waste.
- For more information, contact the retailer or the local authorities in charge of waste management.

This symbol on the battery indicates that the battery is to be collected separately. The following apply only to users in European countries:



- All batteries, whether marked with this symbol or not, are designated for separate collection at an appropriate collection point. Do not dispose of as household waste.
- For more information, contact the retailer or the local authorities in charge of waste management.

Table of Contents









For Your Safety	ii
WARNINGS	ii
Notices	v
<hr/>	
Introduction	1
About This Manual	1
Information and Precautions	2
Parts of the Camera	4
The Camera Body	4
The Monitor	6
Basic Operations	8
The  (Shooting Mode) Button	8
The  (Playback) Button	8
The Multi Selector	9
The MENU Button	10
Switching Between Tabs	10
Help Displays	11
Shutter-release Button	11
Attaching the Camera Strap	11
<hr/>	
First Steps	12
Charging the Battery	12
Inserting the Battery	14
Removing the Battery	15
Turning On and Off the Camera	15
Setting Display Language, Date and Time	16
Inserting Memory Cards	18
Removing Memory Cards	18
<hr/>	
 Basic Photography and Playback: Auto Mode	20
Step 1 Turn the Camera On and Select  (Auto) Mode	20
Indicators Displayed in  (Auto) Mode	21
Step 2 Frame a Picture	22
Using the Zoom	23
Step 3 Focus and Shoot	24
Step 4 Playing Back and Deleting Pictures	26
Playing Back Pictures (Playback Mode)	26
Deleting Pictures	26
Using the Flash	28
Setting the Flash Mode	28
Taking Pictures with the Self-timer	30

Table of Contents

Macro Mode	31
Exposure Compensation	32
<hr/>	
 Shooting Suited for the Scene	33
Shooting in Scene Mode	33
Choosing a Scene Mode	33
Features	34
Shooting in the Scene Mode Selected by the Camera (Scene Auto Selector)	41
Taking Pictures in Food Mode	43
Taking Pictures for a Panorama	45
<hr/>	
 Taking Pictures of Smiling Faces (Smart Portrait Mode)	47
Using Smart Portrait Mode	47
Smart portrait menu	48
<hr/>	
 More on Playback/In-Camera Editing	50
Viewing Multiple Pictures: Thumbnail Playback	50
Calendar Display	51
Taking a Closer Look: Playback Zoom	52
Viewing Pictures by Date (List by Date Mode)	53
Selecting a Date in List by Date Mode	53
Using List by Date Mode	54
List by Date Menu	55
Image Searching in Auto Sort Mode	56
Displaying Pictures in Auto Sort Mode	56
Using Auto Sort Mode	58
Auto Sort Menu	58
Sorting Favorite Pictures (Favorite Pictures Mode)	59
Preparing Favorites Folder (setting icons)	60
Sorting Pictures to a Favorites Folder	61
Viewing the Pictures in Favorites Folder	62
Removing Pictures from Favorites	62
Using Favorite Pictures Mode	63
Favorite Pictures Menu	64
Voice Memos: Recording and Playback	66
Recording Voice Memos	66
Playing Voice Memos	67
Deleting Voice Memos	67
Editing Pictures	68
Enhancing Contrast and Saturation (Quick Retouch)	70
Enhancing Brightness and Contrast: D-Lighting	71

































Making Skin Appear Smoother (Skin Softening).....	72
Resizing Pictures: Small Picture.....	73
Creating a Cropped Copy: Crop.....	74
<hr/>	
 Movies	75
Recording Movies	75
The Movie Menu.....	76
 Movie Options.....	76
 Autofocus Mode	77
 Electronic VR	77
Movie Playback	78
Deleting Movie Files.....	78
<hr/>	
Connecting to Televisions, Computers and Printers	79
Connecting to a TV.....	79
Connecting to a Computer.....	80
Before Connecting the Camera.....	80
Transferring Pictures from the Camera to a Computer	81
Connecting to a Printer	84
Connecting the Camera and Printer.....	85
Printing Pictures One at a Time	86
Printing Multiple Pictures	87
Creating a DPOF Print Order: Print Set	90
<hr/>	
MENU Shooting, Playback and Setup Menus	93
Shooting Options: The Shooting Menu	93
Displaying the Shooting Menu	93
 Image Mode	94
 White Balance.....	96
 Continuous	98
 ISO Sensitivity.....	99
 Color Options.....	100
 AF Area Mode.....	101
Functions that Cannot Be Applied Simultaneously.....	105
Playback Options: The Playback Menu	106
Displaying the Playback Menu	106
 Slide Show	108
 Delete	109
 Protect	109
 Rotate Image.....	110
 Copy	110

Table of Contents

Basic Camera Setup: The Setup Menu	112
Displaying the Setup Menu.....	113
 Menus	114
 Welcome Screen	115
 Date.....	116
 Monitor Settings.....	119
 Date Imprint.....	120
 Electronic VR.....	121
 Motion Detection	122
 AF Assist	123
 Digital Zoom	123
 Sound Settings	124
 Auto Off	124
 Format Memory/  Format Card	125
 Language	126
 Video Mode	126
 Blink Warning	126
 Reset All	128
 Ver. Firmware Version	130
Technical Notes	131
Optional Accessories	131
Approved Memory Cards	131
File and Folder Names	132
Caring for the Camera	133
Cleaning	135
Storage.....	136
Error Messages	137
Troubleshooting	142
Specifications	149
Supported Standards	152
Index	153

About This Manual

Thank you for your purchase of a Nikon COOLPIX S570 digital camera. This manual was written to help you enjoy taking pictures with your Nikon digital camera. Read this manual thoroughly before use, and keep it where all those who use the product will read it.

Symbols and Conventions

To make it easier to find the information you need, the following symbols and conventions are used:



This icon marks cautions, information that should be read before use, to prevent damage to the camera.



This icon marks tips, additional information that may be helpful when using the camera.



This icon marks notes, information that should be read before using the camera.



This icon indicates that more information is available elsewhere in this manual or in the *Quick Start Guide*.

Notations

- A Secure Digital (SD) memory card is referred to as a “memory card”.
- The setting at the time of purchase is referred to as the “default setting”.
- The names of menu items displayed in the camera monitor, and the names of buttons or messages displayed in the computer monitor appear in bold.

Screen Samples

In this manual, images are sometimes omitted from monitor display samples so that monitor indicators can be more clearly shown.

Illustrations and Screen Display

Illustrations and text displays shown in this manual may differ from actual display.

Internal Memory and Memory Cards

Pictures taken with this camera can be stored in the camera’s internal memory or on removable memory cards. If a memory card is inserted, all new pictures will be stored on the memory card and delete, playback and format operations will apply only to the pictures on the memory card. The memory card must be removed before the internal memory can be formatted or used to store pictures to, or delete, or view pictures.

Information and Precautions

Life-Long Learning

As part of Nikon's "Life-Long Learning" commitment to ongoing product support and education, continually updated information is available online at the following sites:

- For users in the U.S.A.: <http://www.nikonusa.com/>
- For users in Europe and Africa: <http://www.europe-nikon.com/support/>
- For users in Asia, Oceania, and the Middle East: <http://www.nikon-asia.com/>

Visit these sites to keep up-to-date with the latest product information, tips, answers to frequently asked questions (FAQs), and general advice on digital imaging and photography. Additional information may be available from the Nikon representative in your area. See the URL below for contact information:

<http://imaging.nikon.com/>

Use Only Nikon Brand Electronic Accessories

Nikon COOLPIX cameras are designed to the highest standards and include complex electronic circuitry. Only Nikon brand electronic accessories (including battery chargers, batteries and AC adapters) certified by Nikon specifically for use with this Nikon digital camera are engineered and proven to operate within the operational and safety requirements of this electronic circuitry.

THE USE OF NON-NIKON ELECTRONIC ACCESSORIES COULD DAMAGE THE CAMERA AND MAY VOID YOUR NIKON WARRANTY.

The use of third-party rechargeable Li-ion batteries not bearing the Nikon holographic seal could interfere with normal operation of the camera or result in the batteries overheating, igniting, rupturing, or leaking.

For more information about Nikon brand accessories, contact a local authorized Nikon dealer.



Holographic seal:

Identifies this device as an authentic Nikon product.

Before Taking Important Pictures

Before taking pictures on important occasions (such as at weddings or before taking the camera on a trip), take a test shot to ensure that the camera is functioning normally. Nikon will not be held liable for damages or lost profits that may result from product malfunction.

About the Manuals

- No part of the manuals included with this product may be reproduced, transmitted, transcribed, stored in a retrieval system, or translated into any language in any form, by any means, without Nikon's prior written permission.
- Nikon reserves the right to change the specifications of the hardware and software described in these manuals at any time and without prior notice.
- Nikon will not be held liable for any damages resulting from the use of this product.
- While every effort was made to ensure that the information in these manuals is accurate and complete, we would appreciate it were you to bring any errors or omissions to the attention of the Nikon representative in your area (address provided separately).

Notice Concerning Prohibition of Copying or Reproduction

Note that simply being in possession of material that was digitally copied or reproduced by means of a scanner, digital camera or other device may be punishable by law.

• Items prohibited by law from being copied or reproduced

Do not copy or reproduce paper money, coins, securities, government bonds or local government bonds, even if such copies or reproductions are stamped "Sample". The copying or reproduction of paper money, coins, or securities which are circulated in a foreign country is prohibited. Unless the prior permission of the government was obtained, the copying or reproduction of unused postage stamps or post cards issued by the government is prohibited. The copying or reproduction of stamps issued by the government and of certified documents stipulated by law is prohibited.

• Cautions on certain copies and reproductions

The government has issued cautions on copies or reproductions of securities issued by private companies (shares, bills, checks, gift certificates, etc.), commuter passes or coupon tickets, except when a minimum of necessary copies are to be provided for business use by a company. Also, do not copy or reproduce passports issued by the government, licenses issued by public agencies and private groups, ID cards and tickets, such as passes and meal coupons.

• Comply with copyright notices

The copying or reproduction of copyrighted creative works such as books, music, paintings, woodcut prints, maps, drawings, movies and photographs is governed by national and international copyright laws. Do not use this product for the purpose of making illegal copies or to infringe copyright laws.

Disposing of Data Storage Devices

Please note that deleting images or formatting data storage devices such as memory cards or built-in camera memory does not completely erase the original image data. Deleted files can sometimes be recovered from discarded storage devices using commercially available software, potentially resulting in the malicious use of personal image data. Ensuring the privacy of such data is the user's responsibility.

Before discarding a data storage device or transferring ownership to another person, erase all data using commercial deletion software, or format the device and then completely refill it with images containing no private information (for example, pictures of empty sky). Be sure to also replace any pictures selected for the welcome screen (📖 115). Care should be taken to avoid injury or damage to property when physically destroying data storage devices.

Parts of the Camera

The Camera Body

Introduction

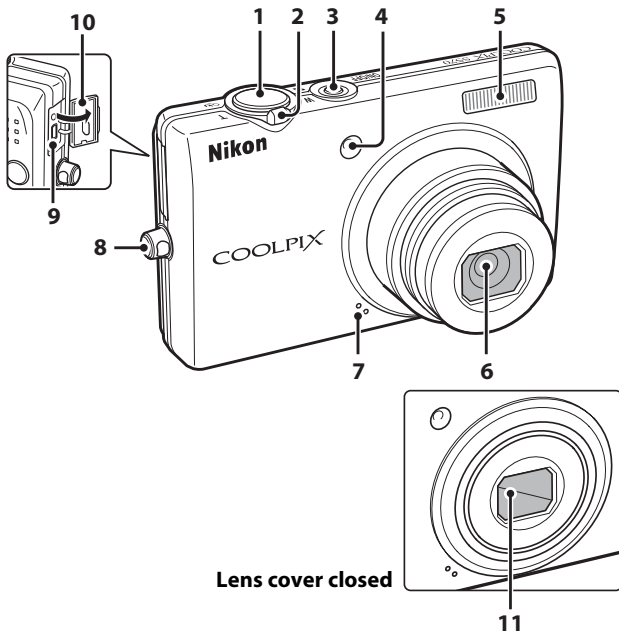

Lens cover closed

1	Shutter-release button.....	24	5	Built-in flash.....	28
	Zoom control.....	23	6	Lens.....	135, 149
	W : wide.....	23	7	Built-in microphone.....	66, 75
2	T : tele.....	23	8	Eyelet for camera strap.....	11
	: thumbnail playback.....	50	9	Cable connector.....	79, 81, 85
	: playback zoom.....	52	10	Pin cover.....	79, 81, 85
	: help.....	11	11	Lens cover.....	133
3	Power switch/Power-on lamp	20, 124			
4	Self-timer lamp.....	30			
	AF-assist illuminator.....	123			

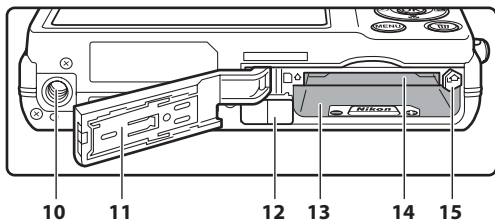
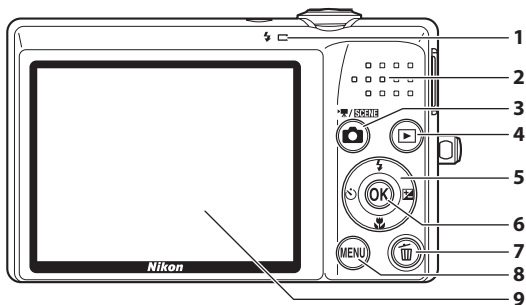

1	Flash lamp	29
2	Speaker	67, 78
3	(shooting mode) button.....	8
4	(playback) button	8, 26
5	Multi selector.....	9
6	(apply selection) button.....	9
7	(delete) button	26, 27, 67, 78
8	MENU button	10, 33, 76, 93, 106, 113
9	Monitor.....	6

10	Tripod socket	
11	Battery-chamber/ memory card slot cover	14, 18
12	Power connector cover (for connection to optional AC adapter).....	131
13	Battery chamber	14
14	Memory card slot	18
15	Battery latch.....	14, 15

The Monitor

The following indicators may appear in the monitor during shooting and playback (actual display varies with current camera settings).

The indicators that appear in the monitor during shooting and playback disappear after a few seconds (📖 119).

Shooting

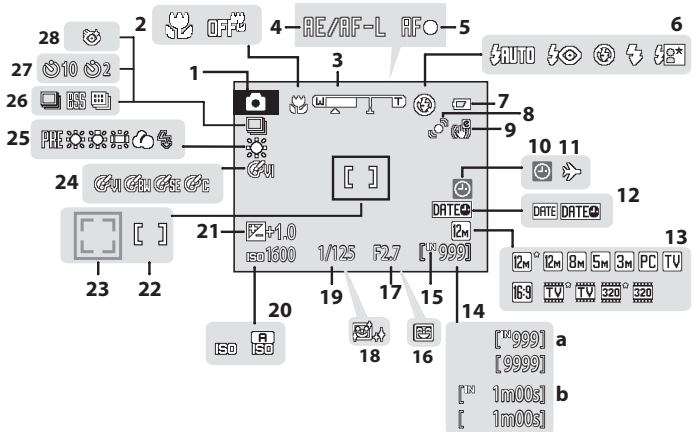

1	Shooting mode*20, 33, 47, 75	15	Internal memory indicator.....21
2	Macro mode31	16	Smile timer.....49
3	Zoom indicator.....23, 31	17	Aperture24
4	AE/AF-L indicator46	18	Skin softening48
5	Focus indicator24	19	Shutter speed24
6	Flash mode.....28	20	ISO sensitivity29, 99
7	Battery level indicator20	21	Exposure compensation value32
8	Motion detection icon21, 122	22	Focus area24, 101
9	Electronic VR icon121	23	Focus area (Face Priority).....24, 101
10	"Date not set" indicator116, 137	24	Color options100
11	Travel destination indicator116	25	White balance mode.....96
12	Date imprint120	26	Continuous shooting mode98
13	Image mode.....94	27	Self-timer indicator30
	Movie options76	28	Blink proof icon.....49
14	a Number of exposures remaining (still pictures).....20		
	b Movie length.....75		

* Differs according to the current shooting mode.

Playback

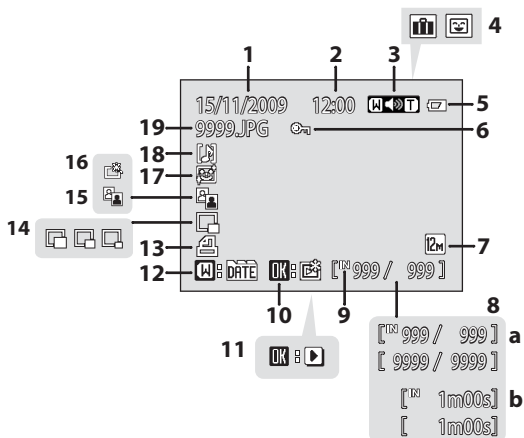

1	Date of recording.....	16	9	Internal memory indicator.....	26
2	Time of recording.....	16	10	Favorite pictures guide.....	61
3	Volume indicator.....	66, 78	11	Movie playback guide.....	78
4	Category icon in auto sort mode ¹	56	12	List by date guide.....	53
5	Battery level indicator.....	20	13	Print set icon.....	90
6	Protect icon.....	109	14	Small picture icon.....	73
7	Image mode ²	94	15	D-Lighting icon.....	71
	Movie options ²	76	16	Quick retouch icon.....	70
8	a Current frame number/ total number of frames.....	26	17	Skin softening icon.....	72
	b Movie length.....	78	18	Voice memo icon.....	67
			19	File number and type.....	132



¹ The icon for the selected category in auto sort mode or the favorites folder currently selected in playback mode is displayed.

² Differs according to the settings configured during shooting.

Basic Operations

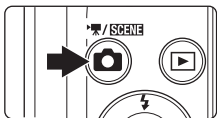
The (Shooting Mode) Button











- Press the  button in playback mode to enter shooting mode.
- Press the  button in shooting mode to display the “shooting-mode selection” menu and change the shooting mode.

The Shooting-mode Selection Menu

Use the multi selector () to select the following shooting modes.







1.  (auto) mode ( 20)
2.  Scene mode ( 33)*
3.  Smart portrait mode ( 47)
4.  Movie mode ( 75)

* The icon displayed differs depending upon the last mode selected.

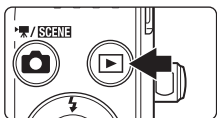
While the shooting-mode selection menu is displayed, press the  button to continue shooting without changing the shooting mode.

The (Playback) Button











- Press the  button in shooting mode to enter playback mode.
- Press the  button in playback mode to display the “playback-mode selection menu” and change the playback mode.
- If the camera is turned off, hold down the  button to turn the camera on in playback mode.

The Playback-mode Selection Menu

Use the multi selector () to select the following playback modes.



1.  Playback mode ( 26)
2.  Favorite pictures mode ( 59)
3.  Auto sort mode ( 56)
4.  List by date mode ( 53)

While the playback-mode selection menu is displayed, press the  button to return to playback mode without changing the playback mode.

The Multi Selector

This section describes standard uses of the multi selector to select modes, select menu options and to apply selection.

Shooting

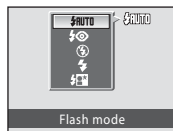
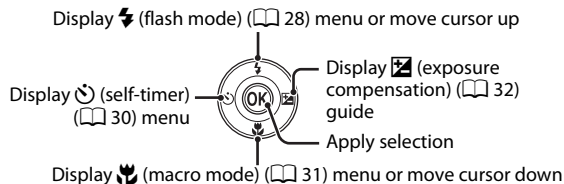

Playback

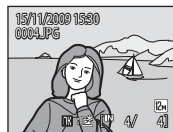
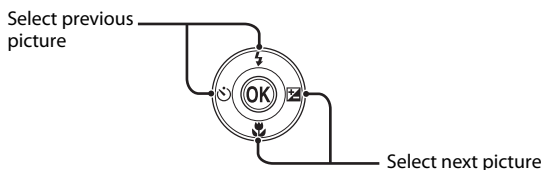

Menu Display

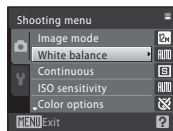
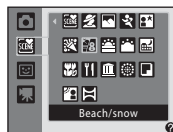
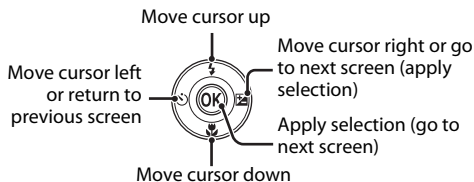

Note on the Multi Selector

In this manual, ▲, ▼, ◀ and ▶ are used in some cases to indicate up, down, left and right operations of the multi selector.

The MENU Button

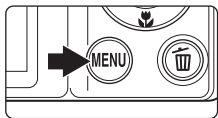

Press the **MENU** button to display the menu for the current mode.

- Use the multi selector to navigate the menus (📖 9).
- Select a tab on the left side of the monitor to display the corresponding menu.
- Press the **MENU** button again to exit the menu.

Displayed when the menu contains two or more pages

- Top tab: Display the available menus in the current mode
- Bottom tab: Display the setup menu

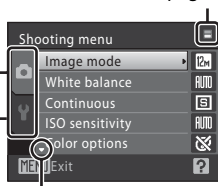

Displayed when there are one or more menu items to follow

Displayed when there are more previous menu items



Select an item, then press the **OK** button or the multi selector **▶** to proceed to the next set of options.

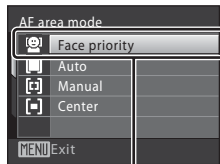

Press the **OK** button or the multi selector **▶** to apply selection.

Switching Between Tabs

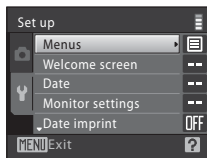
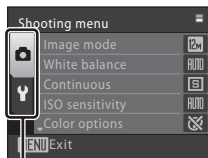
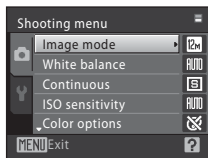

Press the multi selector **◀** to highlight the tab.

Press the multi selector **▲** or **▼** to select the tab, and press either the **OK** button or **▶**.

The selected menu is displayed.

Help Displays

Rotate the zoom control to **T** (?) when **[?]/[?]** is displayed at the lower right of the menu screen to view a description of the currently selected menu option. To return to the original menu, rotate the zoom control to **T** (?) again.

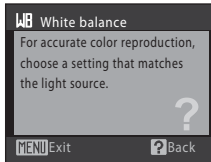
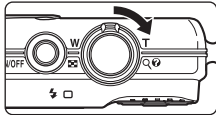

Shutter-release Button

The camera features a two-stage shutter-release button. To set focus and exposure, press the shutter-release button halfway, stopping when you feel resistance. Focus and exposure lock while the shutter-release button is held in this position. To release the shutter and take a picture, press the shutter-release button the rest of the way down. Do not use force when pressing the shutter-release button, as this may result in camera shake and blurred pictures.



Press the shutter-release button halfway to set focus and exposure

Press the shutter-release button the rest of the way down to take picture

Attaching the Camera Strap

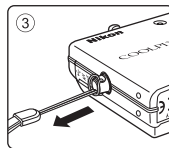
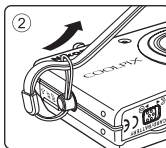
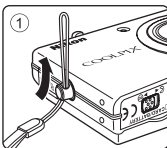

Charging the Battery

Charge the Rechargeable Li-ion Battery EN-EL10 (supplied) with the Battery Charger MH-63 (supplied).

1 Connect the power cable in the following order: ①, ②.

- The CHARGE lamp will light ③.

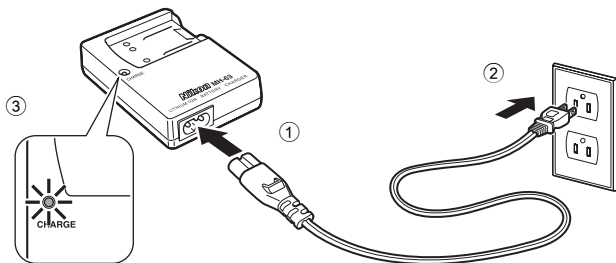

2 Insert the battery at an angle as shown ①, and set it in the battery charger ②.

- The CHARGE lamp starts blinking when charging starts ③.
- About 100 minutes are required to charge a fully depleted battery.

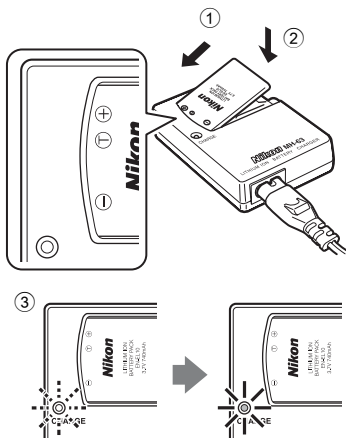

- The following chart explains CHARGE lamp status.

CHARGE lamp	Description
Blinks	Battery charging.
On	Battery fully charged.
Flickers	<ul style="list-style-type: none"> The battery is not inserted correctly. Remove the battery and reinsert it into the battery charger so that the battery is lying flat. Operating temperature range exceeded. Charge the battery indoors with an ambient temperature of 5 °C to 35 °C (41 °F to 95 °F) before use. The battery is faulty. Stop charging immediately, unplug the charger, and take both the battery and charger to your retailer or Nikon service representative.

3 Remove the battery and unplug the charger when charging is complete.

Notes on the Battery Charger

- The supplied battery charger is for use only with the Rechargeable Li-ion Battery EN-EL10. Be sure to use only genuine Nikon brand rechargeable batteries.
- Be sure to read and follow the warnings for the battery charger on pages iii before using the battery charger.

Notes on the Battery

- Be sure to read and follow the warnings for the battery on page iii and the section, “The Battery” (📖 134), before using the battery.
- If the battery is not used for an extended period, recharge it at least once every six months and run it flat before returning it to storage.

AC Power Supply

To power the camera continuously for extended periods, use an AC Adapter EH-62D (available separately from Nikon) (📖 131). Do not, under any circumstances, use another make or model of AC adapter. Failure to observe this precaution could result in overheating or in damage to the camera.

Inserting the Battery

Insert a Rechargeable Li-ion Battery EN-EL10 (supplied) into your camera.

- Charge the battery before the first use or when the battery is running low (📖 12).

1 Open the battery-chamber/memory card slot cover.

- Slide the cover latch toward ⬅️ (①) and open the battery-chamber/memory card slot cover (②).

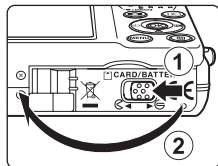

2 Inserting the Battery.

- Confirm that the positive (+) and negative (-) terminals are oriented correctly as described on the label at the entrance of the battery chamber, and insert the battery.
- Use the battery to push the orange battery latch in the direction indicated by the arrow (①) and fully insert the battery (②). When the battery is fully inserted, the battery latch will lock it in place.

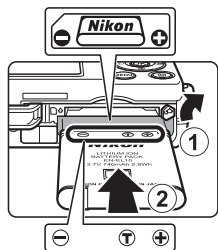

❑ Inserting the Battery

Inserting the battery upside down or backwards could damage the camera. Be sure to check the battery is in the correct orientation.



3 Close the battery-chamber/memory card slot cover.

- Close the battery-chamber/memory card slot cover (①), and slide the cover latch to the ➡️Ⓜ️ position (②).

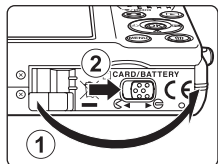

Removing the Battery

Turn the camera off and make sure that the power-on lamp and the monitor have gone out before opening the battery-chamber/memory card slot cover.

To eject the battery, open the battery-chamber/memory card slot cover and slide the orange battery latch in the direction indicated by the arrow (①). The battery can then be removed by hand (②).

- Note that the battery may become hot during use; observe due caution when removing the battery.

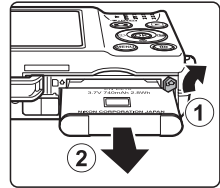

Turning On and Off the Camera

Press the power switch to turn on the camera. The power-on lamp (green) will light for a moment and then the monitor will turn on. To turn off the camera, press the power switch again.

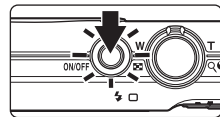

When the camera is turned off, both the power-on lamp and monitor will turn off.

If the camera is turned off, hold down the  button to turn the camera on in playback mode.



Auto Power Off in Shooting Mode (Standby Mode)

If no operations are performed for about a minute (default setting), the monitor will turn off automatically and the camera will enter standby mode. If no operations are performed for another three minutes, the camera will turn off automatically (the auto off function).

- If the monitor is off in standby mode (the power-on lamp is blinking), press the power switch or the shutter-release button to reactivate it.
- The time allowed to elapse from before the camera enters standby mode can be changed from the **Auto off** option ( 124) in the setup menu ( 112).

Setting Display Language, Date and Time

A language-selection dialog is displayed the first time the camera is turned on.

1 Press the power switch to turn on the camera.

- The power-on lamp (green) will light for a moment and the monitor will turn on.

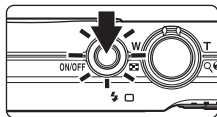

2 Use the multi selector to choose the desired language and press the **OK** button.

- For information on using the multi selector, see "The Multi Selector" (📖 9).



3 Choose **Yes** and press the **OK** button.

- If **No** is selected, the date and time will not be set.

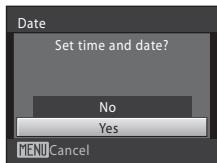

4 Press the multi selector ◀ or ▶ to select your home time zone (📖 118) and press the **OK** button.

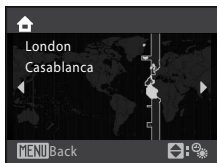

Daylight Saving Time

If daylight saving time is in effect, press the multi selector ▲ in the time zone selection screen displayed in step 4 to turn on the daylight saving time option.

When the daylight saving time option is enabled,  is displayed at the top of the monitor. To turn off the daylight saving time option, press ▼.

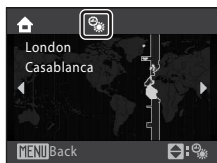

5 Edit the date and time.

- Press ▲ or ▼ to edit the highlighted item.
- Press ► to move the highlight in the following order:
D (day) → **M** (month) → **Y** (year) → hour → minute → **DMY** (the order in which the day, month, and year are displayed)

Press ◀ to return to the previous item.

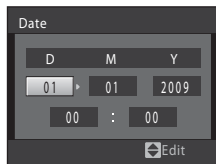
**6** Choose the order in which the day, month and year are displayed and press the **OK** button or press ►.

- The settings are applied and monitor display exits to shooting mode.

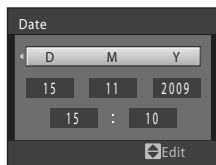
**Changing the Date and Time**

- Select **Date** from the **Date** item (📖 116) in the setup menu (📖 112) to change the current date and time and follow the procedure described in step 5 above.
- Select **Time zone** from the **Date** item in the setup menu to change the time zone and daylight saving time settings (📖 116).

Inserting Memory Cards

Image, sound, and movie files are stored in the camera's internal memory (approximately 47 MB) or on removable Secure Digital (SD) memory cards (available separately) (📖 131).

If a memory card is inserted in the camera, data are automatically stored on the memory card and data recorded to the memory card can be played back, deleted or transferred. Remove the memory card to store data in the internal memory, or play back, delete or transfer data from the internal memory.

- 1 Confirm that the power-on lamp and the monitor are off and open the battery-chamber/memory card slot cover.

- Be sure to turn off the camera before opening the battery-chamber/memory card slot cover.

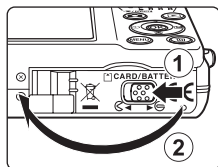

- 2 Insert the memory card.

- Insert the memory card in the correct orientation (as shown on the right) until it clicks into place.
- Close the battery-chamber/memory card slot cover.

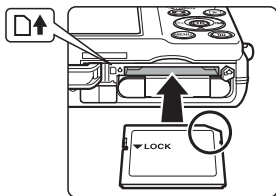

❑ Inserting Memory Cards

Inserting the memory card upside down or backwards could damage the camera or the memory card. Be sure to check the memory card is in the correct orientation.

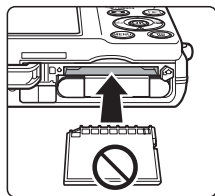

Removing Memory Cards

Before removing memory cards, turn the camera off and confirm that the power-on lamp and monitor are off. Open the battery-chamber/memory card slot cover and press the card in (1) to partially eject the card. The card can then be removed by hand. Do not attempt to remove the card at an angle (2).

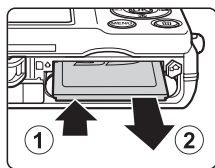

✔ Formatting Memory Cards

If the message at right is displayed, the memory card must be formatted before use (📖 125). Note that **formatting permanently deletes all pictures and other data on the memory card**. Be sure to make copies of any pictures you wish to keep before formatting the memory card.

To format the memory card, use the multi selector to choose **Yes** and press the **OK** button. The confirmation dialog will be displayed. To start formatting, choose **Format** and press the **OK** button.

- Do not turn the camera off or open the battery-chamber/memory card slot cover until formatting is complete.
- The first time you insert the memory cards used in other devices into the COOLPIX S570, be sure to format them using this camera (📖 125).

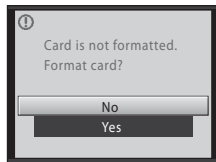

✔ The Write Protect Switch

Memory cards are equipped with a write protect switch. When this switch is in the "lock" position, data cannot be written to, or deleted from, the memory card. If the switch is in the "lock" position, unlock it by sliding the switch to the "write" position to record or delete pictures, or to format the memory card.

Write protect switch

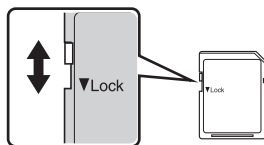

✔ Memory Cards

- Use only Secure Digital memory cards.
- Do not perform the following during formatting, while data is being written to or deleted from the memory card, or during data transfer to a computer. Failure to observe this precaution could result in the loss of data or in damage to the camera or memory card:
 - Take out the battery or memory card
 - Turn off the camera
 - Disconnect the AC adapter
- Do not format the memory card using a computer.
- Do not disassemble or modify.
- Do not drop, bend, or expose to water or strong physical shocks.
- Do not touch the metal terminals with your fingers or metal objects.
- Do not affix labels or stickers to the memory card.
- Do not leave in direct sunlight, closed vehicles or areas exposed to high temperatures.
- Do not expose to humidity, dust, or to corrosive gases.

Step 1 Turn the Camera On and Select (Auto) Mode

This section describes how to take pictures in  (auto) mode, an automatic, “point-and-shoot” mode recommended for first-time users of digital cameras.

1 Press the power switch to turn on the camera.

- The power-on lamp (green) will light for a moment and the monitor will turn on. The lens will also extend.
- Proceed to step 4 if  is displayed.

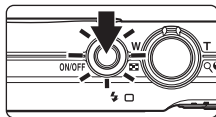

2 Press the button to display the shooting-mode selection menu.

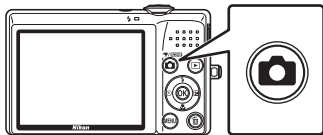

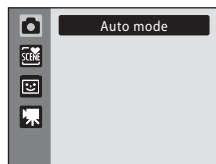

3 Press the multi selector or to choose and press the button.

- The camera enters  (auto) mode.



4 Check the battery level and the number of exposures remaining.

Battery Level

Monitor	Description
NO INDICATOR	Battery fully charged.
	Battery low. Prepare to charge or replace the battery.
 Battery exhausted.	Cannot take pictures. Recharge or replace with a fully charged battery.

Battery level indicator

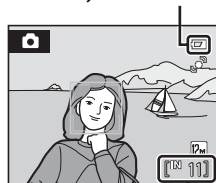

Number of exposures remaining

Number of Exposures Remaining

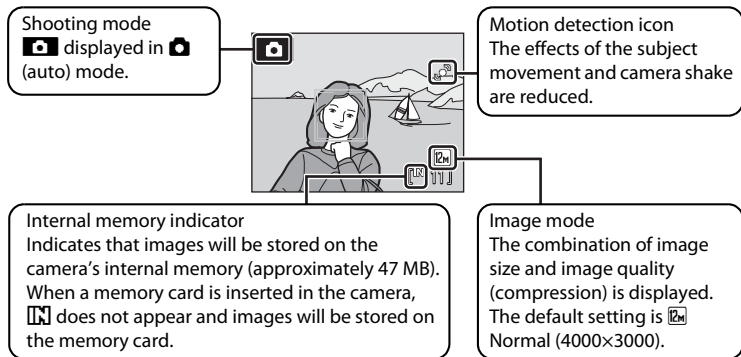

The number of pictures that can be stored depends on the capacity of the internal memory or memory card and image mode setting (📖 95).

Indicators Displayed in (Auto) Mode



The indicators and photo info displayed during shooting and playback will turn off after a few seconds (📖 119). When the monitor has turned off in standby mode to save power, press the power switch or the shutter-release button to reactivate it (📖 124).





Functions Available in (Auto) Mode

In  (auto) mode, macro mode (📖 31) and exposure compensation (📖 32) can be applied and pictures can be taken using the flash mode (📖 28) and self-timer (📖 30). Pressing the **MENU** button in  (auto) mode allows you to specify settings for all shooting menu items (📖 93) depending upon the shooting situations.

Motion Detection

See **Motion detection** (📖 122) in the setup menu (📖 112) for more information.

Electronic Vibration Reduction

When the flash mode (📖 28) is set to  (off) or  (slow sync) with **Electronic VR** (📖 121) in the setup menu set to **Auto**, the  icon may appear in the monitor. The appearance of  indicates shooting conditions in which the effects of camera shake can be pronounced. In these situations, the camera reduces the effects of camera shake in pictures before recording them.

Step 2 Frame a Picture

1 Ready the camera.

- Hold the camera steadily in both hands, keeping your fingers and other objects away from the lens, flash, AF-assist illuminator, microphone, and speaker.
- When taking pictures in “tall” orientation, turn the camera so that the built-in flash is above the lens.

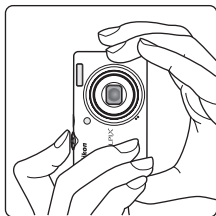

2 Frame the picture.

- When the camera detects a face, that face will be framed by a yellow double border (default setting).
- Up to 12 faces can be detected. When the camera detects more than one face, the face closest to the camera is framed by a double border AF area, and faces outside the AF area are framed by single borders.
- AF area will not appear when shooting pictures of subjects other than people, or framing a subject with which no face is recognized. Position the main subject near the center of the monitor.



Using the Zoom

Use the zoom control to activate optical zoom. Rotate the zoom control to **T** to zoom in so that the subject fills a larger area of the frame, or **W** to zoom out, thus increasing the area visible in the frame.

A zoom indicator is displayed at the top of the monitor when the zoom control is rotated.

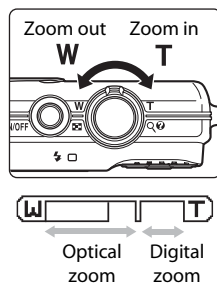

Digital Zoom

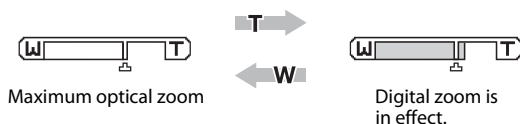

When the camera is zoomed in to the maximum optical zoom position, rotating and holding the zoom control at **T** triggers digital zoom. The subject is magnified up to 4× the maximum optical zoom ratio.

Focus will be on the center of the screen (without active focus area display) when digital zoom is in effect.



Digital Zoom and Interpolation

Unlike optical zoom, digital zoom uses a digital imaging process known as interpolation to magnify images, resulting in slight deterioration of picture quality.

Interpolation is applied at zoom positions beyond . When zoom is increased beyond the  position, interpolation is initiated and the zoom indicator turns yellow to indicate that interpolation is being applied. The position of  moves to the right as image size decreases, allowing for confirmation of the zoom positions at which shooting without interpolation is possible at the current image mode setting.

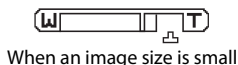

When an image size is small

- Digital zoom can be disabled from the **Digital zoom** option ( 123) in the setup menu ( 112).

Step 3 Focus and Shoot

1 Press the shutter-release button halfway.

- The camera focuses when the shutter-release button is pressed halfway (📖 11).
- When the subject is in focus, the active focus area glows green.

When a face is detected:

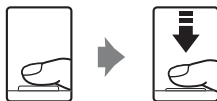

Shutter speed Aperture

When a face is not detected:

- The camera automatically selects the focus area (one of nine) containing the subject closest to the camera. When the subject is in focus, the active focus area glows green.

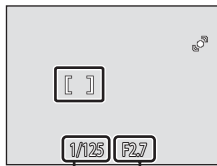

Shutter speed Aperture

- When digital zoom is used, the focus area is not displayed and the camera focuses at the center of the frame. Once focus has been acquired, the focus indicator (📖 6) will glow green.
- When you press the shutter-release button halfway, the shutter speed and aperture values also appear.
- Focus and exposure remain locked while the shutter-release button is pressed halfway.
- If the focus area or focus indicator blinks red when the shutter-release button is pressed halfway, the camera will be unable to focus. Change the composition and press the shutter-release button halfway again.

2 Press the shutter-release button the rest of the way down.

- The shutter is released and the picture will be recorded to the memory card or internal memory.



During Recording

While pictures are being recorded, the number of exposures remaining will blink. **Do not open the battery-chamber/memory card slot cover** while pictures are being recorded. Cutting power or removing the memory card in these circumstances could result in loss of data or in damage to the camera or card.

Autofocus

Autofocus may not perform as expected in the following situations. In some rare cases, the subject may not be in focus despite the fact that the active focus area and the focus indicator glow green:



- Subject is very dark
- Objects of sharply differing brightness are included in the scene (e.g. the sun is behind the subject and is in deep shadow)
- No contrast between the subject and surroundings (e.g. when the subject is standing in front of a white wall, wearing a white shirt)
- Several objects are at different distances from the camera (e.g. the subject is inside a cage)
- Subject is moving rapidly

In the situations noted above, try pressing the shutter-release button halfway to refocus several times, or focus on another subject and use focus lock ( 102). When using focus lock, be sure that the distance between the camera and the subject with which focus was locked is the same as that for the actual subject.

Face Priority

See “**AF Area Mode**” ( 101) or “**Face Priority**” ( 103) for more information about Face Priority.











AF-assist Illuminator and Flash

If the subject is poorly lit, the AF-assist illuminator ( 123) may light when the shutter-release button is pressed halfway, or the flash ( 28) may fire when the shutter-release button is pressed all the way down.

Step 4 Playing Back and Deleting Pictures

Playing Back Pictures (Playback Mode)

Press the  (Playback) button.

- The last picture taken will be displayed in full-frame playback mode.
- Press the multi selector , ,  or  to view additional pictures. Press and hold , ,  or  to fast forward.
- Pictures may be displayed briefly at low resolution while being read from the memory card or internal memory.
- Press the  button or the shutter-release button to switch to shooting mode.
- When playing back pictures stored on the camera's internal memory,  appears. When a memory card is inserted in the camera,  does not appear and images stored on the memory card are played back.

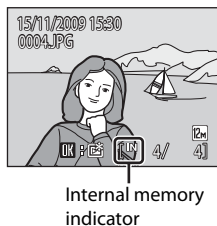
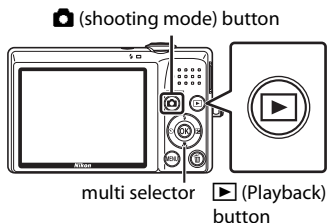

Deleting Pictures

- 1 Press the  button to delete the picture currently displayed in the monitor.

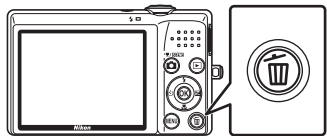





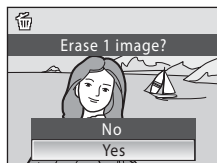



- 2 Use the multi selector to select **Yes** and press the  button.

- Deleted pictures cannot be recovered.
- To exit without deleting the picture, choose **No** and press the  button.



Options Available in Playback Mode





The following options are available in full-frame playback mode.

Option	Use	Description	
Playback zoom	T (Q)	Rotate the zoom control to T to enlarge the picture up to 10x. Press the  button to return to full-frame playback mode.	52
View thumbnails/apply calendar display	W (Z)	Rotate the zoom control to W to display 4, 9 or 16 picture thumbnails or to apply the calendar display.	50, 51
Add favorite pictures		Add the picture currently displayed to favorite pictures.	61
Change playback mode		Press the  button to display the playback-mode selection menu and change to list by date, auto sort, or favorite pictures mode.	53, 56, 62
Switch to shooting mode		Press the  button or the shutter-release button.	26
	 		

Pressing the Button to Turn On the Camera

When the camera is off, holding down the  button will turn the camera on in playback mode. The lens will not extend.

Viewing Pictures

- Pictures stored in the internal memory can only be viewed if no memory card is inserted.
- Pictures that were shot using Face Priority ( 103) will be rotated automatically when displayed in full-frame playback mode according to the orientation of the face (excluding pictures that were shot using **Continuous**, **BSS**, and **Multi-shot 16** ( 98)).
- When the monitor has turned off in standby mode to save power, press the  button or the power switch to reactivate it ( 124).

Deleting the Last Picture Taken While in Shooting Mode

In shooting mode, press the  button to delete the last picture taken.

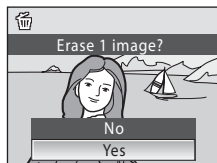

Deleting Multiple Pictures

Multiple pictures can be deleted from the **Delete** option ( 109) in the playback menu ( 106), the list by date menu ( 55), the auto sort menu ( 58), or the favorite pictures menu ( 64).

Using the Flash

The flash has a range of 0.5-5.5 m (1 ft. 8 in.-18 ft.) when the camera is zoomed out all the way. With maximum optical zoom applied, the range is 0.5-2.2 m (1 ft. 8 in.-7 ft. 3 in.) (when ISO sensitivity is set to Auto). The following flash modes are available.

AUTO Auto

Flash fires automatically when lighting is poor.

Auto with red-eye reduction

Reduce “red-eye” in portraits ( 29).

Off

Flash will not fire even when lighting is poor.

Fill flash

Flash fires whenever a picture is taken. Use to “fill-in” (illuminate) shadows and backlit subjects.

Slow sync

 AUTO (auto) is combined with slow shutter speed.





Flash illuminates main subject; slow shutter speeds are used to capture background at night or under dim light.

Setting the Flash Mode

- 1 Press  (flash mode).
 - The flash menu is displayed.



- 2 Use the multi selector  or  to choose the desired mode and press the  button.

- The icon for the selected flash mode is displayed at the top of the monitor.
- When  AUTO (auto) is applied,  AUTO is only displayed for a few seconds, regardless of **Photo info** settings ( 119).
- If a setting is not applied by pressing the  button within a few seconds, the selection will be cancelled.

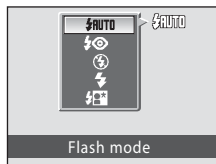

✓ Shooting When Lighting is Poor and the Flash is Disabled (📷)

- Use of a tripod is recommended to stabilize the camera during shooting and avoid the effects of camera shake.
- The **[ISO]** indicator is displayed when the camera automatically increases sensitivity. Pictures taken when **[ISO]** is displayed may be slightly mottled.

✓ Note on Using the Flash

Reflections from dust particles in the air may appear as bright spots in pictures. To reduce these reflections, set the flash to **[📷]** (off).

📌 The Flash Lamp

The flash lamp indicates the flash status when the shutter-release button is pressed halfway down.

- On: Flash will fire when picture is taken.
- Blinks: Flash charging. Wait a few seconds and try again.
- Off: Flash will not fire when picture is taken.

If the battery is low, the monitor display will turn off, and remain off, until the flash is fully charged.



📌 The Flash Setting

The default flash mode setting varies with shooting mode.

- **[📷]** (auto): **📷** (AUTO) (auto)
- Scene: varies with the selected scene mode (📖 34-40)
- **[👤]** (smart portrait): fixed at **[📷]** (off) when **On** is selected for **Blink proof**, **📷** (AUTO) (auto) when **Off** is selected for **Blink proof** (📖 49)

Flash cannot be used simultaneously with certain features (📖 105).

The flash mode setting applied in **[📷]** (auto) mode is stored in the camera's memory even after the camera is turned off, and reapplied the next time **[📷]** (auto) mode is selected.

📌 Red-eye Reduction

This camera uses advanced red-eye reduction ("In-Camera Red-Eye Fix").

Pre-flashes are fired repeatedly at low intensity before the main flash, reducing the red-eye effect.

If the camera detects "red-eye" when a picture is taken, Nikon's own In-Camera Red-Eye Fix processes the image before it is recorded.

Note the following when taking pictures:

- Because pre-flashes are fired, there is a slight lag between when the shutter-release button is pressed and when the picture is shot. This mode is not recommended when a quick shutter response is required.
- The time required to save the picture increases slightly.
- Advanced red-eye reduction may not produce the desired results in some situations.
- In extremely rare instances, areas not subject to red-eye may be affected by advanced red-eye reduction processing; in these cases, choose another mode and try again.

Taking Pictures with the Self-timer

The camera is equipped with a ten-second and two-second timer for self-portraits. This feature is useful for reducing the effects of camera shake that occurs when pressing the shutter-release button. When using the self-timer, use of a tripod is recommended.

1 Press (self-timer).

- The self-timer menu is displayed.



2 Use the multi selector or to choose **10 s** or **2 s** and press the button.

- **10 s** (ten seconds): Suited for important occasions (such as weddings)
- **2 s** (two seconds): Suited for preventing camera shake
- The mode selected for self-timer is displayed.
- If a setting is not applied by pressing the  button within a few seconds, the selection will be cancelled.

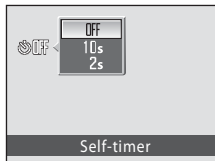

3 Frame the picture and press the shutter-release button halfway.

- Focus and exposure will be set.



4 Press the shutter-release button the rest of the way down.

- The self-timer starts, and the number of seconds remaining before the shutter is released is displayed in the monitor. The self-timer lamp blinks while the timer is counting down. About one second before the shutter is released, the lamp remains lit and stops blinking.
- When the shutter is released, the self-timer will be set to **OFF**.
- To stop the timer before a picture is taken, press the shutter-release button again.

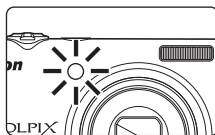
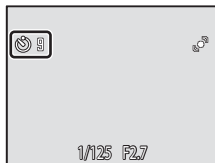

Macro Mode



Macro mode is used for taking pictures of objects as close as 3 cm (1.2 in.). Note that the flash may be unable to light the entire subject at distances of less than 50 cm (1 ft. 8 in.).

1 Press (macro mode).

- The macro menu is displayed.



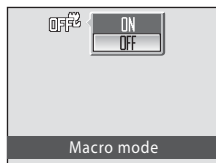

2 Use the multi selector or to choose **ON** and press the button.

- The macro mode icon () is displayed.
- If a setting is not applied by pressing the  button within a few seconds, the selection will be cancelled.



3 Rotate the zoom control to frame the picture.

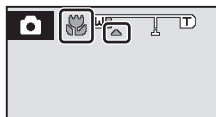

- The closest distance at which the camera can focus varies depending on the zoom position. At the zoom position (wide angle position before the  icon) where the  icon and zoom display glow green, the camera can focus on subjects as close as 4 cm (1.6 in.) from the lens. At the wide-most zoom position, the camera can focus on subjects as close as 3 cm (1.2 in.) from the lens.



Autofocus

When using macro mode, the camera focuses continuously until focus is locked by pressing the shutter-release button halfway. A sound will be heard while the camera focuses.

The Macro Mode Setting

The macro mode setting applied in  (auto) mode is stored in the camera's memory even after the camera is turned off, and reapplied the next time  (auto) mode is selected.

Exposure Compensation



Exposure compensation is used to alter exposure from the value suggested by the camera to make pictures brighter or darker.

1 Press (exposure compensation).

- The exposure compensation guide is displayed.



2 Use the multi selector or to choose the desired setting and press the button.

- When the picture is too dark: adjust the exposure compensation to "+" side.
- When the picture is too bright: adjust the exposure compensation to "-" side.
- Exposure compensation can be set to values between -2.0 and +2.0 EV.
- If a setting is not applied by pressing the  button within a few seconds, the selection will be cancelled.
- When set to any value other than **0.0**, the value is displayed with the  icon in the monitor.

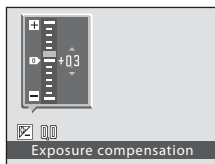

3 Press the shutter-release button to take the picture.

- To turn off exposure compensation, repeat from step 1 and set the value to **0.0**, then press .

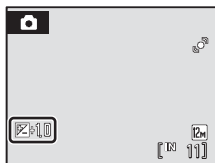

Exposure Compensation Value

The exposure compensation value applied in  (auto) mode is stored in the camera's memory even after the camera is turned off, and reapplied the next time  (auto) mode is selected.

Using Exposure Compensation

- The camera tends to reduce exposure when the frame is dominated by brightly lit objects and to increase exposure when the frame is mostly dark. Positive compensation may therefore be required to capture the brilliancy of very bright objects that fill the frame (for example, sunlit expanses of water, sand, or snow) or when the background is much brighter than the main subject.
- Negative compensation may be called for when large areas of the frame contain very dark objects (for example, a swath of dark green leaves) or when the background is much darker than the main subject.

Shooting in Scene Mode

Camera settings are automatically optimized for the selected subject type. The following scene modes are available.

Scene auto selector	Portrait	Landscape	Sports	Night portrait
Party/indoor	Beach/snow	Sunset	Dusk/dawn	Night landscape
Close-up	Food	Museum	Fireworks show	Copy
Backlight	Panorama assist			

Choosing a Scene Mode

- 1 Press the button in shooting mode to display the shooting-mode selection menu, then press the multi selector or to select a scene icon.

- The icon for the last scene mode selected is displayed. The default setting is (Scene auto selector).



- 2 Press the multi selector and press , , , or to choose the desired scene, and then press the button.

- The screen changes to the shooting mode screen.
- See “Features” (📖 34) for more information.

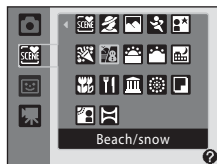

- 3 Frame the subject and shoot.



Image Mode

When the **MENU** button is pressed to display the (scene) menu, **Image mode** (📖 94) can be adjusted. Change made to this setting applies to all shooting modes (except for movie mode).

Features

The following icons are used for descriptions in this section:  = flash mode (📖 28),  = self-timer (📖 30),  = macro mode (📖 31),  = exposure compensation (📖 32).

Scene auto selector

NR

By simply framing a picture, the camera automatically selects the optimum scene mode. See “Shooting in the Scene Mode Selected by the Camera (Scene Auto Selector)” (📖 41) for more information.

			Off ²		Off ³		0.0 ²
---	---	---	------------------	---	------------------	---	------------------

¹ The camera automatically selects the optimum flash mode setting for the scene mode it has selected. Can be changed to  (off).

² Other settings can be selected.

³ Changed to On when the camera selects **Close-up** scene mode.

Portrait

Use this mode for taking portraits in which the main subject stands out clearly.

- If the camera detects a face, it focuses on the face. See “Face Priority” (📖 103) for more information.
- If more than one face is recognized, focus will be on the face nearest to the camera.
- The skin softening feature can make the subject’s (up to three people) skin appear smoother, then record the image (📖 48).
- If no faces are recognized, focus will be on the center of the screen.
- Digital zoom is not available.



			Off*		Off		0.0*
---	---	---	------	---	-----	---	------

* Other settings can be selected.

Landscape

Use this mode for vivid landscapes and cityscapes.

- The camera focuses at infinity. The focus area or focus indicator (📖 6) always glows green when the shutter-release button is pressed halfway. Note, however, that objects in the foreground may not always be in focus.
- AF-assist illuminator (📖 123) does not light.





			Off*		Off		0.0*
---	---	---	------	---	-----	---	------

* Other settings can be selected.

NR: Indicates pictures shot in this scene mode are processed automatically to reduce noise, and therefore may take more time to save.

Sports

Use this mode for dynamic action shots that freeze the action in a single shot and record motion in a series of pictures.

- The camera focuses on the subject in the center of the frame. The camera focuses continuously until focus is locked by pressing the shutter-release button halfway.
- While the shutter-release button is held down, the camera shoots up to 5 pictures at a rate of up to about 0.9 frames per second (fps) (when image mode is set to  **Normal (4000)**).
- Focus, exposure compensation, and white balance are fixed at the values determined with the first shot in each series.
- AF-assist illuminator ( 123) does not light.
- The maximum frame rate with continuous shooting may vary depending upon the current image mode setting and the memory card used.





			Off		Off		0.0*
---	---	---	-----	---	-----	---	------

* Other settings can be selected.

Night portrait

Use this mode for portraits of a human subject shot in front of background lighting at night. Flash is used to illuminate the subject while maintaining the mood of the background.

- If the camera detects a face, it focuses on the face. See “Face Priority” ( 103) for more information.
- If more than one face is recognized, focus will be on the face nearest to the camera.
- The skin softening feature can make the subject’s (up to three people) skin appear smoother, then record the image ( 48).
- If no faces are recognized, focus will be on the center of the screen.
- Digital zoom is not available.



	 ¹		Off ²		Off		0.0 ²
---	--	---	------------------	---	-----	---	------------------

¹ Fill flash with slow sync and red-eye reduction.

² Other settings can be selected.

: For those scene modes with , use of a tripod is recommended.

: Indicates pictures shot in this scene mode are processed automatically to reduce noise, and therefore may take more time to save.

Shooting in Scene Mode

Party/indoor

Suitable for taking pictures in parties. Captures the effects of candlelight and other indoor background lighting.

- The camera focuses on the subject in the center of the frame.
- As pictures are easily affected by camera shake, hold the camera steadily. Use of a tripod is recommended for dark locations.



Off²



Off



0.0²

¹ The flash may change to slow sync with red-eye reduction. Other settings can be selected.

² Other settings can be selected.

Beach/snow

Captures the brightness of such subjects as snowfields, beaches, or sunlit expanses of water.

- The camera focuses on the subject in the center of the frame.



FLASH^{*}



Off^{*}



Off^{*}



0.0^{*}

^{*} Other settings can be selected.

Sunset



Preserves the deep hues seen in sunsets and sunrises.

- The camera focuses on the subject in the center of the frame.



FLASH^{*}



Off^{*}



Off





0.0^{*}

^{*} Other settings can be selected.

Dusk/dawn



Preserves the colors seen in the weak natural light before sunrise or after sunset.

- The camera focuses at infinity. The focus area or focus indicator ( 6) always glows green when the shutter-release button is pressed halfway. Note, however, that objects in the foreground may not always be in focus.
- AF-assist illuminator ( 123) does not light.





* Other settings can be selected.

Night landscape



Slow shutter speeds are used to produce stunning night landscapes.

- The camera focuses at infinity. The focus area or focus indicator ( 6) always glows green when the shutter-release button is pressed halfway. Note, however, that objects in the foreground may not always be in focus.
- AF-assist illuminator ( 123) does not light.



* Other settings can be selected.





: For those scene modes with , use of a tripod is recommended.

: Indicates pictures shot in this scene mode are processed automatically to reduce noise, and therefore may take more time to save.

Shooting in Scene Mode

Close-up

Use to photograph flowers, insects and other small objects at close range.



- Macro mode ( 31) will be turned on and the camera automatically zooms to the position at the closest distance at which the camera can focus.
- The closest distance at which the camera can focus varies depending on the zoom position. At the zoom position (wide angle position before the  icon) where the  icon and zoom display glows green, the camera can focus on subjects as close as 4 cm (1.6 in.) from the lens. At the wide-most zoom position, the camera can focus on subjects as close as 3 cm (1.2 in.) from the lens.
- **AF area mode** is set to **Manual** ( 101). Press the  button to choose the focus area in which focus is acquired.
- The camera focuses continuously until focus is locked by pressing the shutter-release button halfway.



* Other settings can be selected. Note that the flash may be unable to light entire subject at distances of less than 50 cm (1 ft. 8 in.).

Food

Use this mode when taking pictures of food. See "Taking Pictures in Food Mode" ( 43) for details.



- **AF area mode** is set to **Manual** ( 101). Press the  button to choose the focus area in which focus is acquired.



* Other settings can be selected.

Museum

Use indoors where flash photography is prohibited (for example, in museums and art galleries) or in other settings in which you do not want to use the flash.

- The camera focuses on the subject in the center of the frame.
- BSS (best shot selector) is used when shooting ( 98).
- AF-assist illuminator ( 123) does not light.
- Pictures are easily affected by camera shake; hold the camera steadily.



* Other settings can be selected.

Fireworks show



Slow shutter speeds are used to capture the expanding burst of light from fireworks.

- The camera focuses at infinity. The focus indicator (📖 6) always glows green when the shutter-release button is pressed halfway. Note, however, that objects in the foreground may not always be in focus.
- AF-assist illuminator (📖 123) does not light.



Copy

Provides clear pictures of text or drawings on a white board or in print.

- The camera focuses on the subject in the center of the frame.
- Use macro mode (📖 31) to focus at short ranges.
- Colored text and drawings may not show up well.



* Other settings can be selected.

Backlight

Use when light is coming from behind the subject, throwing features or details in shadow. The flash fires automatically to “fill in” (illuminate) shadows.

- The camera focuses on the subject in the center of the frame.



* Other settings can be selected.

Shooting in Scene Mode

Panorama assist



Use to take a series of pictures that will later be joined to form a single panorama using the supplied Panorama Maker software. See "Taking Pictures for a Panorama" (📖 45) for details.





* Other settings can be selected.

Shooting in the Scene Mode Selected by the Camera (Scene Auto Selector)

By simply framing a picture, the camera automatically selects the optimum scene mode for simpler shooting.

When the camera is aimed at a subject in  scene auto selector mode, the camera automatically selects one of the following scene modes.

- Auto (typical photography)
- Landscape (📖 34)
- Night landscape (📖 37)
- Backlight (📖 39)
- Portrait (📖 34)
- Night portrait (📖 35)
- Close-up (📖 38)

- 1 Press the  button in shooting mode to display the shooting-mode selection menu and use the multi selector to select  (Scene auto selector) (📖 33).

- The camera enters scene auto selector scene mode.



- 2 Frame the subject and take the picture.

- When the camera automatically selects a scene mode, the shooting mode icon changes to that for the scene mode currently enabled.

 : Auto

 : Portrait

 : Landscape

 : Night portrait

 : Night landscape

 : Close-up

 : Backlight

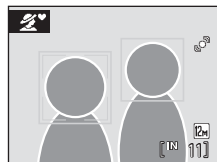



- Press the shutter-release button halfway to set focus and exposure. When the subject is in focus, the active focus area glows green.
- Press the shutter-release button the rest of the way down to take the picture.

Note on Scene Auto Selector Scene Mode



Depending upon shooting conditions, the camera may not select the desired scene mode. Should this occur, switch to  (auto) mode (📖 20) or choose the desired scene mode manually (📖 33).

Focusing When Using Scene Auto Selector Mode

- When using scene auto selector mode, if the camera detects a face, it focuses on the face (Face Priority → 📖 103).
- When the shooting mode icon is  or  (Close-up), just as when **AF area mode** (📖 101) is set to **Auto**, the camera automatically selects the focus area (one of nine) containing the subject closest to the camera.

Flash Mode in Scene Auto Selector Scene Mode

 **AUTO** (Auto) (default setting) and  (Off) flash mode settings can be applied (📖 28).

- When  **AUTO** (Auto) is applied, the camera automatically selects the optimum flash mode setting for the scene mode it has selected.
- When  (Off) is applied, the flash does not fire, regardless of shooting conditions.

Functions Restricted in Scene Auto Selector Scene Mode

- Digital zoom is not available.
- The macro mode button on the multi selector (📖 9, 31) is disabled.

Taking Pictures in Food Mode

Use this mode when taking pictures of food.

- 1 Press the  button in shooting mode to display the shooting-mode selection menu and use the multi selector to select  (Food) ( 33).

- Macro mode ( 31) will be turned on and the camera automatically zooms to the position at the closest distance at which the camera can focus.







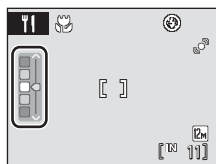





- 2 Press the multi selector  or  to choose white balance.

- Press  to increase the amount of red, or  to increase the amount of blue.



- 3 Frame the picture.

- The closest distance at which the camera can focus varies depending on the zoom position. At the zoom position (wide angle position before the  icon) where the  icon and zoom display glow green, the camera can focus on subjects as close as 4 cm (1.6 in.) from the lens. At the wide-most zoom position, the camera can focus on subjects as close as 3 cm (1.2 in.) from the lens.
- **AF area mode** is set to **Manual** ( 101). Press the  button to move the focus area. Press the multi selector , , , or  to select a focus area and press the  button again to activate the selected focus area.
- Self-timer ( 30) and exposure compensation ( 32) settings can be adjusted while the focus area is locked.

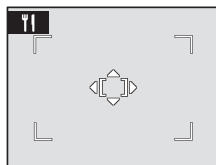
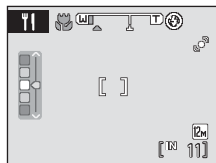

4 Press the shutter-release button to take the picture.

- Focus is locked when the shutter-release button is pressed halfway, and a picture is taken when the shutter-release button is pressed the rest of the way down.
- When the camera is unable to focus, the focus area blinks red. Change the composition and press the shutter-release button halfway again.



Note on Food Mode



Flash mode is disabled. Macro mode setting (📖 31) is fixed at **ON**.

White Balance Setting in Food Mode

- Increasing the amount of red or blue will decrease illumination effects.
- Changing white balance in food mode will not affect white balance in the shooting menu (📖 96).
- The white balance setting applied in food mode is stored in the camera's memory even after the camera is turned off, and reapplied the next time food mode is selected.

Taking Pictures for a Panorama









The camera focuses on the subject in the center of the frame. Use a tripod for the best results.

- 1 Press the  button in shooting mode to display the shooting-mode selection menu and use the multi selector to select  (Panorama assist) ([book 33](#)).

- Panorama direction icons () are displayed to show the direction in which pictures will be joined.



- 2 Use the multi selector to choose the direction and press the  button.

- Select how pictures will be joined together in the completed panorama; right () , left () , up () or down () .
- The yellow panorama direction icon () will move to the direction pressed and press the  button to choose the direction. A white panorama direction icon () will be displayed in the chosen direction.
- Apply flash mode ([book 28](#)), self-timer ([book 30](#)), macro mode ([book 31](#)) and exposure compensation ([book 32](#)) settings with this step, if necessary.
- Press the  button again to reselect the direction.



- 3 Take the first picture.

- One third of the last picture taken will be displayed partially transparent.



- 4 Take the next picture.

- Compose the next picture so that one-third of the frame overlaps the previous picture.
- Repeat until you have taken the necessary number of pictures to complete the scene.

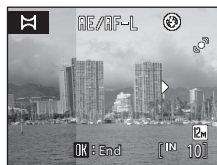

5 Press the **OK** button when shooting is complete.

- The camera returns to step 2.



✓ Panorama Assist

- Set flash mode, self-timer, macro mode and exposure compensation before taking the first picture. They cannot be changed after the first picture is taken. Pictures cannot be deleted, nor can zoom or **Image mode** setting (📖 94) be adjusted after the first picture is taken.
- Shooting for the panorama series is terminated if the auto off function (📖 124) initiates standby mode during shooting. Setting the time allowed to elapse before the auto off function is enabled to a longer setting is recommended.

🔒 AE/AF-L Indicator

When using panorama assist mode, all pictures in the panorama have the same exposure, white balance, and focus as the first picture of the panorama. When the first picture is shot, **AE/AF-L** is displayed to indicate that exposure, white balance, and focus are locked.



🔍 Panorama Maker





Install Panorama Maker from the supplied Software Suite CD. Transfer pictures to a computer (📖 80) and use Panorama Maker (📖 83) to join them in a single panorama.

🔍 More Information

See "File and Folder Names" (📖 132) for more information.

Using Smart Portrait Mode

At the default setting, the camera detects smiling faces using face priority and releases the shutter automatically (smile timer function). The skin softening function makes the subject's skin appear smoother.

- 1 Enter smart portrait mode by pressing the  button in shooting mode and selecting  (press the multi selector  or ) , and then pressing the  button.

- Smart portrait mode is selected.

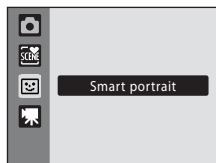



- 2 Frame a picture.

- Point the camera at the subject.
- When the camera detects a face, the focus area containing the face will be displayed with a yellow double border, and when focus is locked the double border will turn green for a moment.
- Up to three faces can be detected. When the camera detects more than one face, the face closest to the center of the frame is framed by a double border and the others by single borders.



- 3 The shutter is automatically released.

- If the camera detects that the face framed by the double border is smiling, the **Smile timer** function ( 48) automatically releases the shutter.
- The self-timer lamp ( 4) blinks when the camera detects a face, and it flickers immediately after the shutter is released. Each time the shutter is released, the camera repeats automatic shooting by face priority and smile detection.
- The shutter can also be released by pressing the shutter-release button. If no face is detected, the camera focuses on the subject in center of frame.
- When the shutter is released, the camera makes the subject's skin appear smoother, then records the image (**Skin softening** ( 48)).

- 4 Finish shooting.

- To finish automatic shooting of smiling faces, either turn the camera off, set **Smile timer** to **Off**, or press the  button and select another shooting mode.

✓ Face Priority and Smiling Face Detection Features

- Under some shooting conditions, faces and smiling faces may not be detected properly.
- See "Notes on Face priority" (📖 104) for more information.

✍ Auto Power Off When Using Smile Timer (Standby Mode)

When **Smile timer** is set to **On**, the auto off function (📖 124) will turn the camera off in the following situations if no operations are performed.

- The camera does not recognize any faces
- The camera recognized the face but cannot detect a smiling face

✍ Functions Available in Smart Portrait Mode

- Flash cannot be used when **Blink proof** is set to **On**. When **Blink proof** is set to **Off**, flash mode (📖 28) changes to **FLASH AUTO** (auto) (other settings can be selected).
- Exposure compensation (📖 32) can be adjusted.
- If **Smile timer** and **Blink proof** are both set to **Off**, self-timer (📖 30) can be set.
- Macro mode cannot be used.
- Digital zoom is not available.
- Press the **MENU** button to display the  (smart portrait) menu and change the settings for **Image mode**, **Skin softening**, **Smile timer**, or **Blink proof**.

🔍 More Information

See "Autofocus" (📖 25) for more information.

Smart portrait menu

The smart portrait menu contains the following options.

Press the **MENU** button in smart portrait mode to display the smart portrait menu and use the multi selector to modify and apply settings.

Image mode

Allows you to set **Image mode** (📖 94).

Changes made to the image mode setting apply to all shooting modes (except movie mode).

Skin softening

Set skin softening. When the shutter is released, the camera detects up to 3 faces and processes the image to make the faces appear smoother, then records the image. The effect of this feature can be set to **High**, **Normal** (default setting), and **Low**. When **Off** is selected, skin softening is turned off.

- When skin softening is enabled, the icon for the current setting is displayed in the monitor during shooting (📖 6). When **Off** is selected, an icon for the current setting is not displayed. Additionally, the effects of the current skin softening setting cannot be previewed in the monitor while shooting. To confirm, view the pictures after shooting.

Smile timer

- **On** (default setting): Among the detected faces, if a smile is detected in the face that is framed by a double border, the camera automatically releases the shutter.
- **Off**: The camera does not release the shutter automatically using smile timer; the shutter is only released when the shutter-release button is pressed.
- When smile timer is enabled, the current setting is displayed during shooting (📖 6). When **Off** is selected, an icon for the current setting is not displayed.

Blink proof

When set to **On**, the shutter is released two times each time a picture is taken; the camera chooses one image in which the subjects' eyes are open, and saves it.

- The message on the right will be displayed for a few seconds when the camera records an image in which someone may have been blinking.
- When set to **On**, the flash cannot be used.
- The default setting is **Off**.
- When blink proof is enabled, the current setting is displayed during shooting (📖 6). When **Off** is selected, an icon for the current setting is not displayed.



✓ Notes on Skin Softening

- When taking pictures with skin softening, the time required to save the pictures increases slightly.
- Depending on shooting conditions, even if the camera detects a face on the monitor at the time of shooting, effects of the skin softening function may not be visible, and areas other than the face may be processed. If the desired effect is not achieved, set **Skin softening** to **Off** and shoot again.
- The amount of skin softening effect that is applied cannot be set while using the portrait or night portrait scene modes.
- Skin softening can also be applied to pictures after they have been taken (📖 72).

Viewing Multiple Pictures: Thumbnail Playback

Rotate the zoom control to **W** (📺) in full-frame playback mode (📖 26) to display pictures in “contact sheets” of thumbnail images.

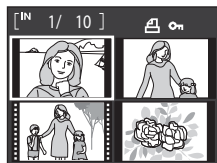

The following operations are available while thumbnails are displayed.

To	Use	Description	📖
Choose pictures		Press the multi selector ▲, ▼, ◀, or ▶.	9
Increase the number of pictures displayed/apply the calendar display	W (📺)	Rotate the zoom control to W (📺) to increase the number of picture thumbnails displayed: 4 → 9 → 16. Rotate the zoom control to W (📺) in the 16-picture thumbnail display to apply the calendar display (📖 51), and pictures can be found by the date on which they were taken. Rotate the zoom control to T (📺) to return to thumbnail display.	—
Decrease the number of pictures displayed	T (📺)	Rotate the zoom control to T (📺) to decrease the number of picture thumbnails displayed: 16 → 9 → 4. Rotate to T (📺) in 4-picture thumbnail display to return to full-frame playback mode.	—
Cancel thumbnail playback	OK	Press the OK button.	26
Switch to shooting mode		Press the button or the shutter-release button.	26

Thumbnail Playback Mode Display

When pictures for which **Print set** (📖 90) and **Protect** (📖 109) settings have been configured are selected, the icons in the illustration to the right appear.

Movies are displayed as film frames.

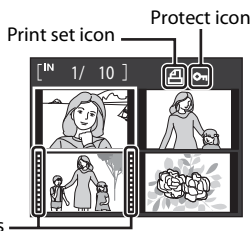

Thumbnail Display in Auto Sort and Favorite Pictures Mode

- When thumbnails are displayed in auto sort mode (📖 56), the category icon of the pictures will appear at the right top of the screen.
- When thumbnails are displayed in favorite pictures mode (📖 59), the favorite pictures icon will appear at the right top of the screen.

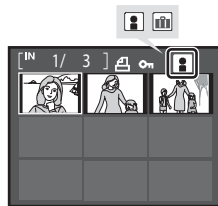





Calendar Display

Rotate the zoom control to **W** (📐) when the pictures are displayed in 16-thumbnail (📖 50) in playback mode to switch to calendar display.

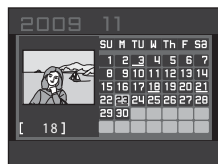
Selecting a date displays the first picture taken on that date in full-frame playback mode. The dates on which the pictures were taken are underlined in yellow.

The following operations are available in calendar display.



To	Use	Description	
Select a date		Press the multi selector ▲ , ▼ , ◀ , or ▶ .	9
Return to full-frame playback		The first picture taken on the selected date is displayed full frame.	26
Return to thumbnail display	T (📐)	Rotate the zoom control to T (📐).	50

Notes on Calendar Display

- Pictures taken before the date and time have been set are recognized as having been taken on 01/01/2009 in the calendar display.
- The  button and **MENU** button are not available in calendar display.

List by Date Mode

Only the pictures taken on the same date can be played back in list by date mode (📖 53). The playback menu operations (📖 55) are also available only for the pictures taken on the selected dates.

Taking a Closer Look: Playback Zoom

Rotating the zoom control to **T** (Q) during full-frame playback mode (📖 26) zooms the current picture, with the center of the picture displayed in the monitor.

The guide at lower right shows which portion of the picture is enlarged.

The following operations are available while pictures are zoomed in.



To	Use	Description	📖
Zoom in	T (Q)	Zoom increases each time the zoom control is rotated to T (Q), to a maximum of 10x.	–
Zoom out	W (📐)	Zoom decreases each time the zoom control is rotated to W (📐). When the magnification ratio reaches 1x, the display returns to full-frame playback mode.	–
View other areas of picture		Press the multi selector ▲ , ▼ , ◀ , or ▶ to move the display area to other areas of the picture.	9
Switch to full-frame playback	OK	Press the OK button.	26
Crop picture	MENU	Press the MENU button to crop current picture to contain only the portion visible in the monitor.	74
Switch to shooting mode		Press the button or the shutter-release button.	26

Pictures Taken in Face Priority

When zooming in (playback zoom) on a picture taken using the face priority function (📖 103) by rotating the zoom control to **T** (Q), the picture will be enlarged so that the face detected at the time of shooting is in the center of the monitor (excluding pictures that were shot using **Continuous**, **BSS** and **Multi-shot 16** (📖 98)).

- If more than one face was detected, the picture will be enlarged with the face on which focus was acquired at the center of the monitor. Press the multi selector **▲**, **▼**, **◀**, or **▶** to display other faces that were detected.
- When the zoom control is rotated to **T** (Q) or **W** (📐) to adjust the zoom ratio, the center of the picture (normal playback zoom display), rather than the face, is displayed at the center of the monitor.







Viewing Pictures by Date (List by Date Mode)

In the **DATE** list by date mode, you can playback only the images taken on the same date. In full-frame playback mode, just as with the normal playback mode, pictures can be viewed as thumbnails, picture displays can be enlarged, pictures can be edited, and movies can be played back.

By pressing the **MENU** button to display the "List by Date Menu" (📖 55), you can delete all pictures with the same date, view a slide show of pictures with the same date, and set print set or protect for all pictures with the same date.

Selecting a Date in List by Date Mode



- 1 Press the  button in playback mode to display the playback-mode selection menu and press the multi-selector  or  to choose **DATE**, and then press the  button.

- Dates for which pictures exist will be listed.



- 2 Select the desired date.

- The camera lists up to 29 dates. If pictures exist for more than 29 dates, all pictures recorded earlier than most recent 29 dates will be listed together as **Others**.

- When the  button is pressed, the first picture taken on the selected date will be displayed full-frame.
- Select images and press the  button to sort the displayed images to the favorites folder (📖 61).
- Rotate the zoom control to **W**  in full-frame playback mode to return to the list by date screen.

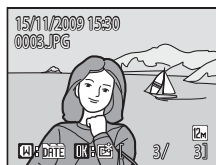
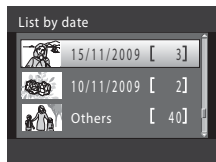













✓ Notes on List by Date Mode

- Up to 9,000 pictures can be displayed in list by date mode. If more pictures exist, "∞" is displayed next to the number.
- Pictures taken before the date and time have been set are recognized as having been taken on 01/01/2009.











Using List by Date Mode

The following operations are available in the list by date screen.

To	Use	Description	
Select date		Press the multi selector ▲ or ▼ to select a date.	9
Switch to full-frame playback		Press the  button to display the first picture taken on the selected date. Rotate the zoom control to W () in full-frame playback mode to return to the list by date screen.	26
Delete picture		Press the  button to delete all pictures taken on the selected date. Choose Yes on the confirmation dialog to be displayed.	26
View list by date menu	MENU	Press the MENU button to display the list by date menu.	55
Change playback mode		Press the  button to display the playback-mode selection menu.	8
Switch to shooting mode		Press the  button or the shutter-release button.	26
	 		

List by Date Menu

Press the **MENU** button in list by date mode to perform the following operations on the pictures taken on the specified date.

Quick retouch*	→  70
D-Lighting*	→  71
Skin softening*	→  72
Print set	→  90
Slide show	→  108
Delete	→  109
Protect	→  109
Rotate image*	→  110
Small picture*	→  73
Voice memo*	→  66

* During full-frame playback only













When the **MENU** button is pressed in the list by date screen ( 53), options can be applied to all pictures taken on the same date, or all pictures taken on the same date can be deleted. To apply options to individual pictures, or to select individual pictures for deletion, display a picture full-frame and press the **MENU** button.





Image Searching in Auto Sort Mode

Pictures and movies will automatically be sorted in any of the following folders during shooting. If  auto sort mode is selected, pictures and movies can be viewed by selecting the folder to which they were sorted with shooting.

 Smile	 Portraits	 Food
 Landscape	 Dusk to dawn	 Close-ups
 Movie	 Retouched copies	 Other scenes

In full-frame playback mode, just as with the normal playback mode, thumbnail playback mode and calendar playback mode can be displayed, picture displays can be enlarged, pictures can be edited, and movies can be played back. Pictures can also be sorted into folders. By pressing the **MENU** button to display the “Auto Sort Menu” ( 58), you can delete all pictures in the same folder, view a slide show of pictures in the same folder, and set print set or protect for all pictures in the same folder.



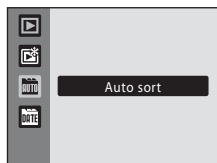

Displaying Pictures in Auto Sort Mode

- 1 Press the  button in playback mode to display the playback-mode selection menu and press the multi selector  or  to choose , and then press the  button.

A list of categories appears.







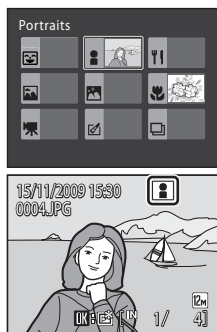





- 2 Choose an auto sort category.

- See “Categories and the Contents” ( 57) for more information about auto sort categories.
- Press  to display pictures in the selected folder in full-frame playback mode.
- The icon of the category currently played back will be displayed in the top right of the screen.
- Select images and press the  button to sort the displayed images to the favorites folder ( 61).



Categories and the Contents

Folder name	Description
 Smile	Pictures taken in smart portrait mode (📖 47) while smile timer was set to On .
 Portraits	Pictures taken in  (auto) mode (📖 20) using face priority (📖 103). Pictures taken in Portrait* , Night portrait* , Party/indoor , and Backlight* scene mode (📖 33). Pictures taken in smart portrait mode (📖 47) while smile timer was set to Off .
 Landscape	Pictures taken in Landscape* scene mode (📖 33).
 Dusk to dawn	Pictures taken in Night landscape* , Sunset , Dusk/dawn or Fireworks show scene mode (📖 33).
 Close-ups	Pictures taken in  (auto) mode using macro (📖 31). Pictures taken in Close-up* scene mode (📖 33).
 Food	Pictures taken in Food (📖 43) scene mode (📖 33).
 Movie	Movies recorded in movie mode (📖 75).
 Retouched copies	Edited pictures (📖 68).
 Other scenes	All pictures that are not included in the other folders.











* The pictures taken in **Scene auto selector** scene mode (📖 41) are included.

Notes on Auto Sort Mode

- Up to 999 pictures and movie files can be added to each folder in auto sort mode. If the desired folder already contains 999 pictures, new pictures or movies cannot be added or displayed in auto sort mode. Display pictures and movies that could not be added to a folder in normal playback mode (📖 26) or list by date mode (📖 53).
- Pictures or movies copied from the internal memory or the memory card (📖 110) cannot be displayed in auto sort mode.
- Pictures or movies recorded by a camera other than the COOLPIX S570 cannot be displayed in auto sort mode.











Using Auto Sort Mode

The following operations are available in the category list screen.

To	Use	Description	
Select the folder name		Press the multi selector ▲, ▼, ◀, or ▶ to select the folder.	9
Switch to full-frame playback		Press the OK button to display the first picture in the selected folder.	26
Delete picture		Press the  button after selecting a category, and a confirmation dialogue will be displayed. Choose Yes and press the OK button to delete all pictures sorted to that category.	26
Change playback mode		Press the  button to display the playback-mode selection menu.	8
Switch to shooting mode	 	Press the  button or the shutter-release button.	26

Auto Sort Menu

Press the **MENU** button in full-frame playback mode or thumbnail display mode of auto sort mode to display the following menus.

Quick retouch	→  70
D-Lighting	→  71
Skin softening	→  72
Print set	→  90
Slide show	→  108
Delete	→  109
Protect	→  109
Rotate image	→  110
Small picture	→  73
Voice memo	→  66

Sorting Favorite Pictures (Favorite Pictures Mode)



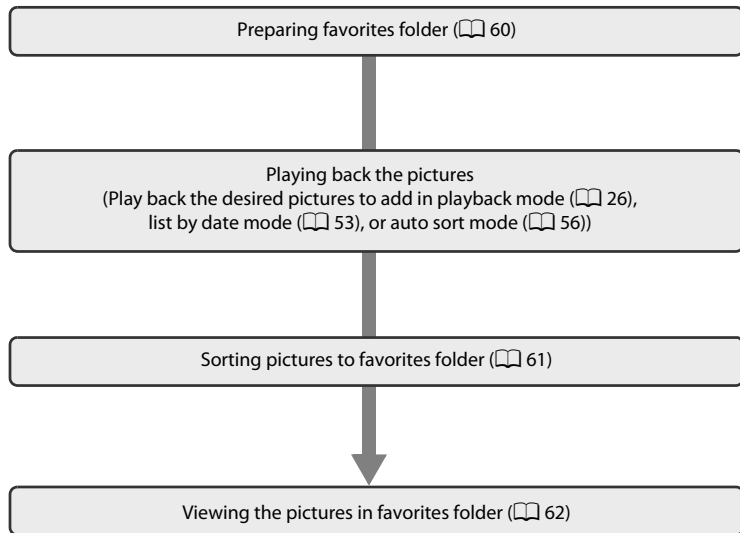

Pictures can be added to the favorites folder sorted by each event such as travel or wedding. Once pictures are added to the favorites folder, only pictures in the selected folder can be played back. One picture can be added to multiple folders.

Sorting/Playback Procedure



Preparing Favorites Folder (setting icons)

Changing the display icons for favorites folders enables you to see which pictures have been added to a favorites folder. The icons can be changed again after adding the pictures to the folders.

- 1 Press the  button in playback mode to display the playback-mode selection menu and press the multi selector  or  to choose , and then press the  button.

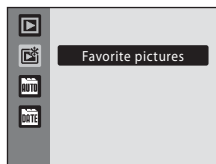

- A list of favorite folders is displayed.





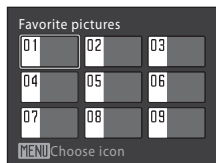

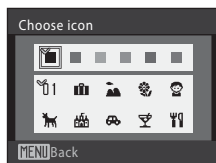

- 2 Choose the favorites folder and press the **MENU** button.

- Icon selection screen is displayed.



- 3 Use the multi selector  or  to choose an icon color and press the  button.



- 4 Use , , , or  to choose an icon and press the  button.

- The icon will be changed and the monitor display will return to the list of favorite folders screen.

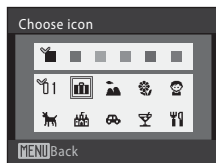

Icons for Favorites Folder

- Choose icons for favorites folders separately for the internal memory and for every memory card used.
- Remove the memory card from the camera to change favorites folder icons for the internal memory.
- When favorite pictures stored to the internal memory, or a memory card, are played back without an icon having been selected, icons are displayed as numbers (default setting).

Sorting Pictures to a Favorites Folder

Pictures can be added to favorites folders and sorted. Adding the pictures enables easier and faster searching.

1 Playback the pictures in playback mode (📖 26), list by date mode (📖 53), or auto sort mode (📖 56).

2 Select your favorite picture and press the **OK** button.

- Select full-frame playback mode and press the **OK** button.
- The favorites folders selection screen is displayed.

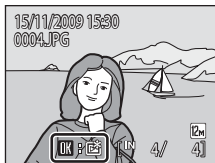

3 Use the multi selector to choose the favorites folder you want to add the picture to and press the **OK** button.

- The pictures are added to the selected favorites folder.

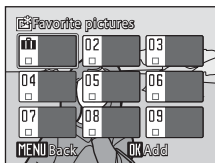



✓ Notes on Adding Favorite Pictures





- A favorites folder can contain up to 200 pictures.
- If the selected picture has been already added to the favorites folder, the checkbox on the selected folder will have the On mark (✓).
- One picture can be added to multiple favorite folders.
- When pictures are added to a favorites folder, they are not physically copied to a favorites folder (📖 132) or moved from the folder to which they were originally recorded (📖 65).
- Movies cannot be added to favorites folders.

💡 More information

See "Removing Pictures from Favorites" (📖 62) for more information.

Viewing the Pictures in Favorites Folder

In  Favorite pictures playback mode, the Favorites folder with the pictures can be chosen and displayed. In full-frame playback mode, just as with the normal playback mode, thumbnail playback mode and calendar playback mode can be displayed, picture displays can be enlarged, pictures can be edited, and movies can be played back. By pressing **MENU** in full-frame playback mode or thumbnail display mode, you can display the Favorite pictures playback menu ( 64), from which you can select pictures taken on a specified day to view as a slide show, set for printing or protection, etc.

- 1 Press the  button in playback mode to display the playback-mode selection menu, press the multi-selector  or  to choose , and press the **OK** button.

- A list of favorites folders is displayed.

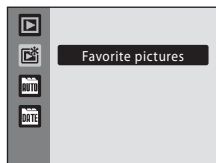

- 2 Choose a Favorite folder.

- Press **OK** to display pictures in the selected folder in full-frame playback mode.
- The icon of the favorites folder currently played back will be displayed on the top right of the screen.

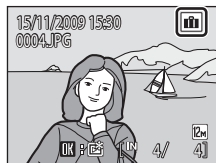
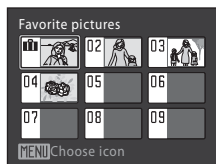

Removing Pictures from Favorites

To remove pictures from a favorites folder without deleting the pictures, use the procedure below. Press the **OK** button in the full-frame display in step 2 above and the removing favorites screen will be displayed. Choose **Yes** and press the **OK** button to remove the picture. To cancel, choose **No**.













Notes on Deleting

Deleting a picture during favorite pictures playback will delete the original file that has been registered to the favorites folder ( 65).











Using Favorite Pictures Mode

The following operations are available in the favorites folders list screen.

To	Use	Description	
Select favorites folder		Press the multi selector ▲, ▼, ◀, or ▶.	9
Switch to full-frame playback		Press the  button to display the first picture in the favorites folder.	26
Delete picture		All pictures that are registered to the selected folder are deleted. Choose Yes and press the  button to delete all pictures sorted to that favorites folder.	26
Change the icon for favorites folder	MENU	Change the icon for favorites folder.	60
Change playback mode		Press the  button to display the playback-mode selection menu.	8
Switch to shooting mode		Press the  button or the shutter-release button.	26
			

Favorite Pictures Menu

Press the **MENU** button in full-frame playback mode or thumbnail display mode in favorite picture playback mode to display the following menus.

Quick retouch	→  70
D-Lighting	→  71
Skin softening	→  72
Print set	→  90
Slide show	→  108
Delete	→  109
Protect	→  109
Rotate image	→  110
Small picture	→  73
Voice memo	→  66

Adding/Viewing Favorite Pictures

When pictures are added to a favorites folder, they are not physically copied to a favorites folder or moved from the folder to which they were originally recorded (📖 132). Only the file names of pictures are added to favorites folders. In favorite pictures mode, pictures with file names that have been added to the favorites folder are played back.

Deleting a picture during favorite pictures playback (📖 26, 63, 109) will delete the original file that has been registered to the favorites folder.

Adding to Favorites

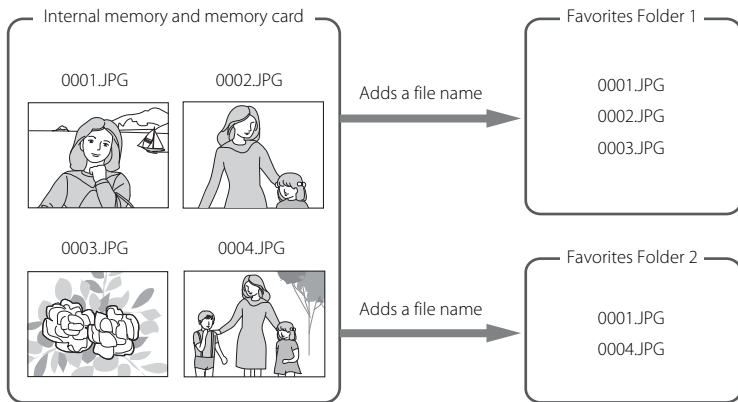

Favorite Picture Playback

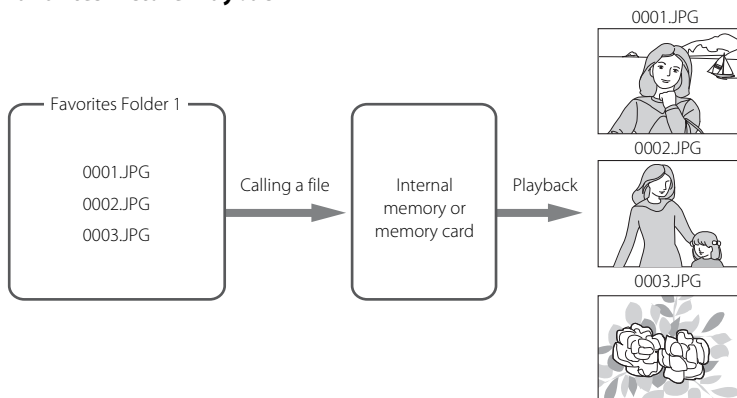

Voice Memos: Recording and Playback

Use the camera's built-in microphone to record voice memos for pictures.

Recording Voice Memos

- 1 Display the desired picture in full-frame playback mode (📖 26) or thumbnail display mode (📖 50) and press the **MENU** button.

- The playback menu is displayed.

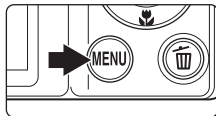

- 2 Use the multi selector to choose **Voice memo** and press the **OK** button.

- The screen for recording voice memos is displayed.

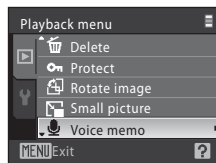

- 3 Press and hold the **OK** button to record a voice memo.

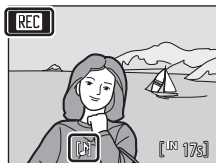
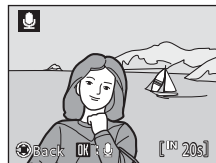

- Recording ends after about 20 seconds or when the **OK** button is released.
- Do not touch the built-in microphone during recording.
- During recording, **REC** and  blink in the monitor.
- When recording ends, the voice memo playback screen is displayed. Follow the instructions in step 3 of "Playing Voice Memos" (📖 67) to play the voice memo.
- Press the **MENU** button before or after recording a voice memo to return to full-frame playback mode.



More Information

Playing Voice Memos

Pictures for which voice memos have been recorded are indicated by  in full-frame playback mode.

- 1 Display the desired picture in full-frame playback mode ( 26) or thumbnail display mode ( 50) and press the **MENU** button.

- The playback menu is displayed.

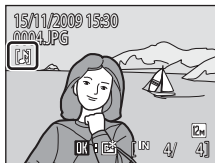

- 2 Use the multi selector to choose  **Voice memo** and press the **OK** button.

- The screen for playing voice memos is displayed.

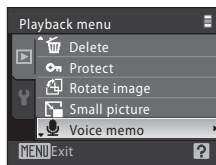



- 3 Press the **OK** button to listen to the voice memo.

- Playback ends when the voice memo ends or the **OK** button is pressed again.
- Use the zoom control **T** or **W** to adjust the volume.
- Press the **MENU** button before or after playing a voice memo to return to full-frame playback mode.



Deleting Voice Memos

Select a picture with a voice memo and press the  button. Use the multi selector to choose  and press the **OK** button. Only the voice memo will be deleted.

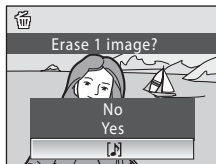

Voice Memos

- When a picture with a voice memo attached is deleted, both the picture and its voice memo are deleted.
- If a voice memo already exists for the current picture, it must be deleted before a new voice memo can be recorded.
- The COOLPIX S570 is not able to attach a voice memo to pictures recorded by other cameras.

Editing Pictures

Use the COOLPIX S570 to edit pictures in-camera and store them as separate files (📖 132). The editing features described below are available.

Editing function	Description
Quick retouch (📖 70)	Easily create retouched copies in which contrast and saturation have been enhanced.
D-Lighting (📖 71)	Create a copy of the current picture with enhanced brightness and contrast, brightening dark portions of the picture.
Skin softening (📖 72)	Makes the subject's skin appear smoother.
Small picture (📖 73)	Create a small copy of pictures suitable for use on web pages or as e-mail attachments.
Crop (📖 74)	Enlarge the image or refine the composition and create a copy containing only the portion visible in the monitor.

Notes on In-camera Editing

- Pictures taken at an **Image mode** setting of **16:9 (3968)** (📖 94) cannot be edited.
- The COOLPIX S570 editing functions are not available for pictures taken with non-COOLPIX S570 digital cameras.
- If no faces can be detected in the image, the image cannot be edited with skin softening (📖 72).
- If a copy created using the COOLPIX S570 is viewed on a different digital camera, the picture may not be displayed or may not be transferred to a computer.
- Editing functions are not available when there is not enough free space in the internal memory or on the memory card.

Restrictions on Picture Editing

The following limitations apply when editing pictures that were created by editing.

Copies Created By:	Can Be Edited By:
Quick retouch	Skin softening, small picture, or crop can be used.
D-Lighting	Quick retouch and D-Lighting cannot be used together.
Skin softening	Quick retouch, D-Lighting, small picture, or crop can be used.
Small picture Crop	No additional editing functions can be used.

- Copies created by the editing functions cannot be edited again using the same edit function.
- To use an editing function together with small picture or crop, use the other edit function first, and use small picture or crop as the last edit function performed on that picture.
- Pictures that were taken using skin softening can be edited using skin softening.

 **Original Pictures and Edited Copies**

- Copies created with editing functions are not deleted if the original pictures are deleted. The original pictures are not deleted if copies created with editing functions are deleted.
- Edited copies are stored with the same recording date and time as the original.
- Print set (📖 90) and Protect (📖 109) settings configured for original pictures are not reflected in their edited copies.

Enhancing Contrast and Saturation (Quick Retouch)

Quick retouch can be used to easily create retouched copies in which contrast and saturation have been enhanced. Copies created with the quick retouch option are stored as separate files.

- 1 Select the desired picture from full-frame (📖 26) or thumbnail (📖 50) playback mode and press the **MENU** button.

- The playback menu is displayed.

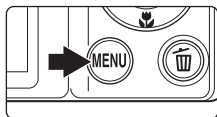

- 2 Use the multi selector to choose  **Quick retouch** and press the **OK** button.

- The original version is displayed on the left and the edited version is displayed on the right.

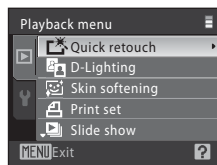

- 3 Press the multi selector **▲** or **▼** to choose the amount of enhancement performed and press the **OK** button.

- A new, retouched picture is created.
- To cancel, press the **MENU** button.
- Copies created with the quick retouch option can be recognized by the  icon displayed during playback.

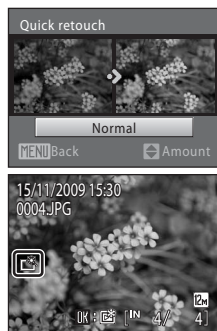

More Information

See "File and Folder Names" (📖 132) for more information.

Enhancing Brightness and Contrast: D-Lighting

D-Lighting can be used to create copies with enhanced brightness and contrast, brightening dark portions of a picture. Enhanced copies are stored as separate files.

- 1 Select the desired picture from full-frame (📖 26) or thumbnail (📖 50) playback mode and press the **MENU** button.

- The playback menu is displayed.

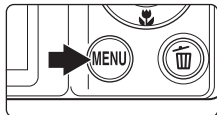

- 2 Use the multi selector to choose  **D-Lighting** and press the **OK** button.

- The original version is displayed on the left and the edited version is displayed on the right.

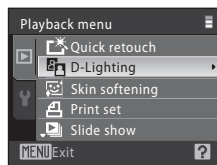

- 3 Choose **OK** and press the **OK** button.

- A new copy with enhanced brightness and contrast is created.
- To cancel, choose **Cancel** and press the **OK** button.

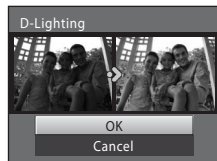

- D-Lighting copies can be recognized by the  icon displayed during playback.



More Information

See "File and Folder Names" (📖 132) for more information.

Making Skin Appear Smoother (Skin Softening)

Skin softening can be applied to faces that are detected in pictures already taken, to make skin appear smoother. Pictures edited with this function are stored as separate files.

- 1 Select the desired picture from full-frame (📖 26) or thumbnail (📖 50) playback mode and press the **MENU** button.

- The playback menu is displayed.

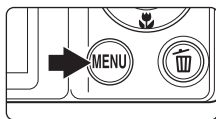

- 2 Use the multi selector to choose  **Skin softening** and press the **OK** button.

- The screen that allows you to set the amount of skin softening appears.
- If no faces can be detected in the image, a warning is displayed and the screen returns to the playback menu.

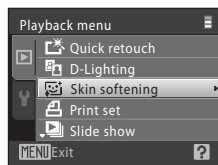

- 3 Press the multi selector **▲** or **▼** to choose the amount of enhancement performed and press the **OK** button.

- A confirmation screen is displayed, and the image is displayed zoomed in on the face edited by skin softening.

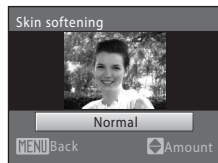

- 4 Confirm the results.

- Up to 12 faces, in order of proximity to the center of the frame, can be enhanced.
- When multiple faces are edited using skin softening, use the multi selector **◀** and **▶** to switch the face that is displayed.
- To adjust the amount of skin softening, press the **MENU** button and return to step 3.
- Press the **OK** button to create a copy edited with skin softening.
- Pictures edited with skin softening can be recognized by the  icon displayed during playback.





Notes on Skin Softening

Depending on conditions such as the direction the subject is facing or the brightness of the face, the face may not be detected properly, or the desired effect may not be achieved.

Resizing Pictures: Small Picture

Create a small copy of the current picture. The following sizes are available. Copies are stored as separate files with a compression ratio of 1:16.

Option	Description
 640×480	Suited to television playback.
 320×240	Suited to display on web pages.
 160×120	Suited to e-mail attachments.

- 1 Select the desired picture from full-frame (📖 26) or thumbnail (📖 50) playback mode and press the **MENU** button.

- The playback menu is displayed.

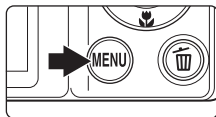

- 2 Use the multi selector to choose  **Small picture** and press the **OK** button.

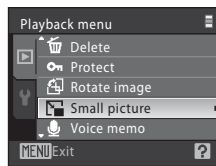

- 3 Choose the desired copy size and press the **OK** button.

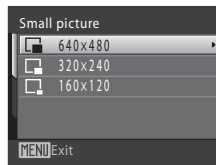

- 4 Choose **Yes** and press the **OK** button.

- A new, smaller copy is created.
- To cancel, choose **No** and press the **OK** button.
- The copy is displayed with a gray frame.

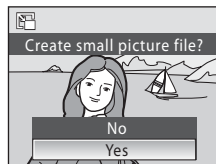

More Information

See "File and Folder Names" (📖 132) for more information.

Creating a Cropped Copy: Crop

Create a copy containing only the portion visible in the monitor when **MENU**  is displayed with playback zoom (📖 52) enabled. Cropped copies are stored as separate files.

1 Rotate the zoom control to **T** (Q) in full-frame playback mode to zoom in on the image.

- To crop a picture displayed in “tall” (portrait) orientation, zoom in on the picture until the black bars displayed on the both sides of the monitor disappear. The cropped picture will be displayed in landscape orientation. To crop the picture in its current “tall” (portrait) orientation, first, use the **Rotate image** option (📖 110) to rotate the picture so that it is displayed in landscape orientation. Next, enlarge the picture for cropping, crop the picture, and then rotate the cropped picture back to “tall” (portrait) orientation.

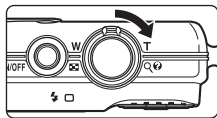

2 Refine copy composition.

- Rotate the zoom control to **T** (Q) or **W** (📐) to adjust the zoom ratio.
- Press the multi selector **▲**, **▼**, **◀** or **▶** to scroll the picture until only the portion you want to copy is visible in the monitor.



3 Press the **MENU** button.

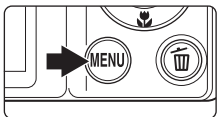



4 Use the multi selector to choose **Yes** and press the **OK** button.

- A new picture, containing only the portion visible in the monitor, is created.
- To cancel, choose **No** and press the **OK** button.



Image Size





As the area to be saved is reduced, the image size (pixels) of the cropped copy is also reduced. When the size of the cropped copy is 320 × 240 or 160 × 120, the small picture icon  or  is displayed on the left of the screen in full-frame playback mode.

More Information

See “File and Folder Names” (📖 132) for more information.

Recording Movies

To shoot movies with sound recorded via the built-in microphone, select shooting mode and follow the steps below.

- 1** Enter movie mode by pressing the  button in shooting mode and selecting  (press the multi selector  or ) , and then pressing the .

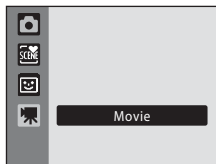



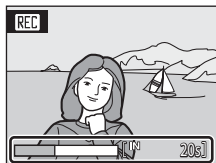

- The maximum length of the movie that can be recorded is displayed in the monitor ( 76). The maximum movie length for each movie is 25 minutes, regardless of memory card capacity.

- 2** Press the shutter-release button all the way down to start recording.

- The camera focuses on the subject in the center of the frame.
- A progress bar at the bottom of the monitor shows the amount of recording time remaining.
- To end recording, press the shutter-release button all the way down a second time.
- If recording time runs out, recording stops automatically.





Recording Movies

- Macro mode ( 31) is enabled. Flash ( 28), self-timer ( 30), and exposure compensation ( 32) are disabled.
- Macro mode setting cannot be applied or changed while movies are being recorded. Apply or change setting as necessary before movie recording begins.
- Optical zoom cannot be adjusted once movie recording begins. Digital zoom cannot be applied before movie recording begins. However, digital zoom (up to 2x) can be applied while movies are being recorded.
- The angle of view (field of view) when recording movies is smaller than when taking still pictures.

Note on Recording Movies

When the movie has been fully recorded to the internal memory or memory card, the monitor display will revert to the normal shooting mode display. **Do not open the battery-chamber/memory card slot cover** while movies are being recorded. Removing the memory card while movies are being recorded could result in loss of data or in damage to the camera or card.

Changing Movie Settings

Movie options ( 76), **Autofocus mode** ( 77), and **Electronic VR** ( 77) settings can be changed.





The Movie Menu

Movie options, **Autofocus mode** (📖 77), and **Electronic VR** (📖 77) settings can be changed. Press the **MENU** button in movie mode to display the movie menu and use the multi selector to modify and apply settings.





🔊 Movie Options

Set to 🔊 (Movie) → MENU (Movie menu) → 🔊 Movie options

The movie menu offers the options shown below.

Option	Image size and frame rate
 TV movie 640★ (default setting)	Image size: 640 × 480 pixels Frame rate: 30 frames per second
 TV movie 640	Image size: 640 × 480 pixels Frame rate: 15 frames per second
 Small size 320★	Image size: 320 × 240 pixels Frame rate: 30 frames per second
 Small size 320	Image size: 320 × 240 pixels Frame rate: 15 frames per second

🔪 Movie Options and Maximum Movie Length

Option	Internal memory (approx. 47 MB)	Memory card (512 MB)
 TV movie 640★ (default setting)	31 s	Approx. 5 min 40 s
 TV movie 640	56 s	Approx. 10 min 20 s
 Small size 320★	1 min 53 s	Approx. 20 min 40 s
 Small size 320	3 min 34 s	Approx. 25 min

* All figures are approximate. The maximum recording time may vary with make of memory card. The maximum movie length for each movie is 25 minutes, regardless of memory card capacity. The maximum recording time that is displayed is the maximum recording time for one movie.



🔍 More Information

See "File and Folder Names" (📖 132) for more information.

Autofocus Mode

Set to  (Movie) → MENU (Movie menu) →  Autofocus mode



Choose how the camera focuses in movie mode.

Option	Description
 Single AF (default setting)	Focus is locked when the shutter-release button is pressed.
 Full-time AF	The camera focuses continuously. To prevent the sound of the camera focusing from interfering with recording, use of Single AF is recommended.

Electronic VR

Set to  (Movie) → MENU (Movie menu) →  Electronic VR

Choose whether to use electronic VR (vibration reduction) when shooting movies.

Option	Description
 On	Reduce the effects of camera shake in all movie modes.
 Off (default setting)	Disable electronic VR.

When vibration reduction is enabled, the current setting is displayed during shooting (when **Off** is selected, an icon for the current setting is not displayed) ( 6).

Movie Playback

In full-frame playback mode (📖 26), movies are recognized by the **Movie options** icon (📖 76). To play a movie, display it in full-frame playback mode and press the **OK** button.

Rotate the zoom control to **T** or **W** to adjust playback volume.

Playback controls appear at the top of the monitor. Press the multi selector ◀ or ▶ to choose a control, then press the **OK** button to perform the selected operation. The following operations are available.

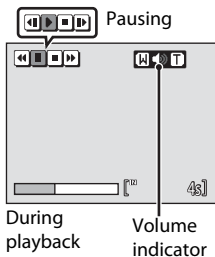
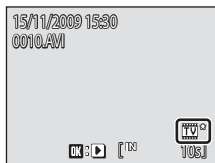

During playback

Volume indicator

To	Use	Description
Rewind	⏮	Rewind movie. Playback resumes when the OK button is released.
Advance	⏭	Advance movie. Playback resumes when the OK button is released.
Pause	⏸	Pause playback. While paused, use the controls to perform the following operations.
		⏮ OK OK OK Rewind movie by one frame. Rewind continues while the OK button is pressed.
		⏭ OK OK OK Advance movie by one frame. Advance continues while the OK button is pressed.
	▶ OK OK Resume playback.	
End	⏹	End playback and return to full-frame playback.

Deleting Movie Files

Press the **Delete** button when displayed in full-frame playback mode (📖 26), or when selected in thumbnail playback mode (📖 50). A confirmation dialog is displayed. Choose **Yes** and press the **OK** button to delete the movie, or choose **No** and press the **OK** button to return to the normal playback display without deleting the movie.

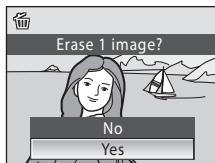

Connecting to a TV

Connect the camera to a television using the supplied audio/video cable (AV cable) to play back pictures on the television.

1 Turn off the camera.

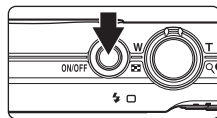

2 Connect the camera to the TV using the supplied AV cable.

- Connect the yellow plug to the video-in jack on the TV, and the white plug to the audio-in jack.

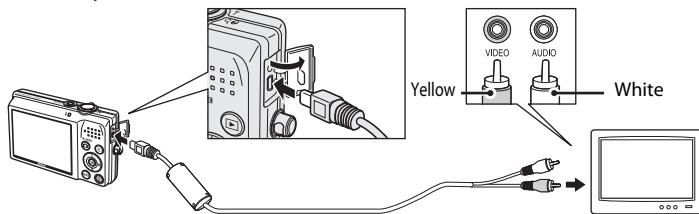

3 Tune the television to the video channel.

- See the documentation provided with your television for details.

4 Hold down the button to turn on the camera.

- The camera enters playback mode, and the pictures taken will be displayed on the television.
- While connected to the TV, the camera monitor will remain off.

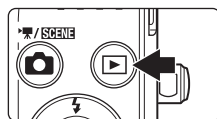

Connecting the Audio/Video Cable

When connecting the AV cable, be sure that the camera connector is oriented correctly. Do not use force when connecting the AV cable to the camera. When disconnecting the AV cable, do not pull the connector at an angle.

Video Mode

Be sure that the camera's video mode setting conforms to the standard used by your television. The video mode setting is an option set in the setup menu (📖 112) → **Video mode** (📖 126).

Connecting to a Computer

Use the supplied USB cable to connect the camera to a computer, and copy (transfer) pictures to the computer with the supplied Nikon Transfer software.

Before Connecting the Camera

Install the Software

Before connecting the camera to a computer, software, including Nikon Transfer, ViewNX for displaying transferred pictures, and Panorama Maker for creating panorama photos, must be installed from the supplied Software Suite CD. For more information on installing the software, refer to the *Quick Start Guide*.

Compatible Operating Systems

Windows

Preinstalled versions of Windows Vista Home Basic/Home Premium/Business/Enterprise/Ultimate (Service Pack 1, 32-bit version)

Windows XP Home Edition/Professional (Service Pack 3)

Macintosh

Mac OS X (version 10.3.9, 10.4.11, 10.5.6)

Refer to the Nikon website for the latest information on operating system compatibility.

Notes on Power Source

- When connecting the camera to a computer, use a fully charged battery to prevent the camera from turning off unexpectedly.
- If the AC Adapter EH-62D (available separately) is used, COOLPIX S570 can be powered from a home electrical outlet. Do not use any other AC adapters as it will cause the camera to heat up or malfunction.

Transferring Pictures from the Camera to a Computer

- 1 Start the computer to which Nikon Transfer was installed.
- 2 Turn off the camera.
- 3 Connect the camera to the computer using the supplied USB cable.

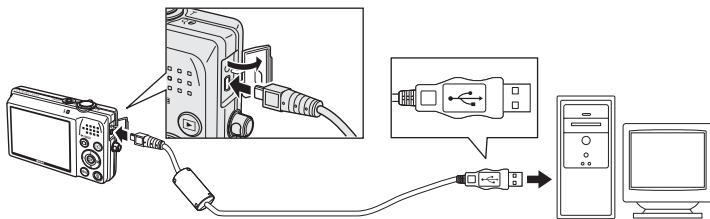

- 4 Turn on the camera.

The power-on lamp will light up. The camera monitor will remain off.

- **Windows Vista**

When the **AutoPlay** dialog is displayed on the computer, click **Copy pictures to a folder on my computer using Nikon Transfer**. Nikon Transfer will start.

To bypass this dialog in the future, check **Always do this for this device**.

- **Windows XP**

When the action selection dialog is displayed, select **Nikon Transfer Copy pictures to a folder on my computer** and click **OK**. Nikon Transfer will start.

To bypass this dialog in the future, check **Always use this program for this action**.

- **Mac OS X**

Nikon Transfer will start automatically if **Yes** was selected in the Auto-Launch setting dialog when Nikon Transfer was first installed.

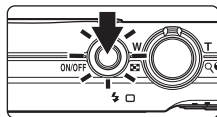

✓ Connecting the USB Cable

- When connecting the USB cable, be sure that the connectors are oriented correctly. Do not use force when connecting the USB cable. When disconnecting the USB cable, do not pull the connector at an angle.
- Connection may not be recognized when the camera is connected to a computer via a USB hub.

- 5** Confirm that the source device is displayed in the transfer options **Source** panel and click **Start Transfer**.

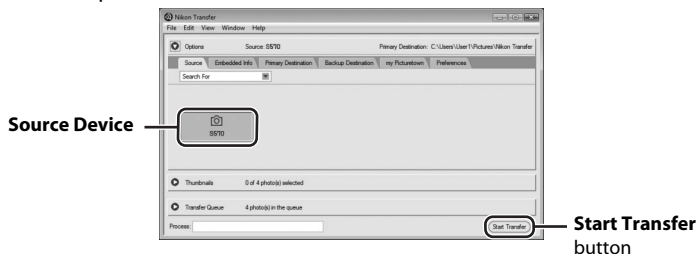

- At the Nikon Transfer default setting, all pictures are transferred to the computer.
- At the Nikon Transfer default settings, ViewNX starts automatically when transfer is complete and transferred pictures can be viewed.

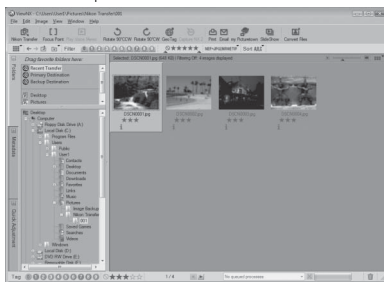

- For more information on using Nikon Transfer or ViewNX, refer to help information contained in Nikon Transfer or ViewNX (83).

Disconnecting the Camera and Computer

- While transferring, do not turn the camera off or disconnect the camera and computer.
- When disconnecting, turn the camera off, then disconnect the USB cable.

Using a Card Reader

The pictures stored on the memory card inserted into a card reader or similar device can also be transferred to the computer using Nikon Transfer.

- If the memory card has a capacity greater than 2 GB, or is SDHC-compliant, the intended device must support these features of the memory card.
- Insert the memory card into the card reader or similar device, then refer to step 4 (📖 81) and transfer pictures.
- To transfer pictures stored in the camera's internal memory to the computer, the pictures must first be copied to a memory card using the camera (📖 110).

Starting Nikon Transfer or ViewNX Manually

- Windows: From the **Start** menu, open **All Programs** → **Nikon Transfer** → **Nikon Transfer** (or **All Programs** → **ViewNX** → **ViewNX**). You can also double-click the **Nikon Transfer** or **ViewNX** shortcut icon on the desktop.
- Mac OS X: Open the **Applications** folder, then double-click **Nikon Software** → **Nikon Transfer** → **Nikon Transfer** (or **Nikon Software** → **ViewNX** → **ViewNX**). You can also click the **Nikon Transfer** or **ViewNX** icon in the dock.

Viewing the Help File for Nikon Transfer or ViewNX

For details on using Nikon Transfer or ViewNX, view the help file by starting Nikon Transfer or ViewNX, then selecting **Help** → **Nikon Transfer Help** or **ViewNX Help**.

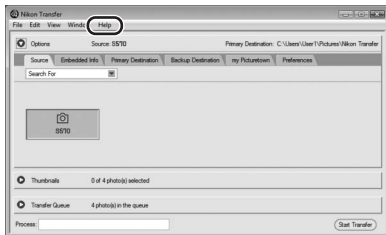

Panorama Creation with Panorama Maker

- Use a series of pictures taken using the **Panorama assist** option in scene mode (📖 40) to create a single panorama photo with Panorama Maker.
- Panorama Maker can be installed to a computer using the supplied Software Suite CD.
- After installation is complete, follow the procedure described below to start Panorama Maker.

Windows

Choose **Start** menu > **All Programs** > **ArcSoft Panorama Maker 4** > **Panorama Maker 4**.

Macintosh

Open Applications by selecting **Applications** from the **Go** menu, and double-click the **Panorama Maker 4** icon.

- For more information on using Panorama Maker, refer to the on-screen instructions and help information contained in Panorama Maker.

Image File Names and Folder Names

See "File and Folder Names" (📖 132) for more information.

Connecting to a Printer

Users of PictBridge-compatible (📖 152) printers can connect the camera directly to the printer and print pictures without using a computer.

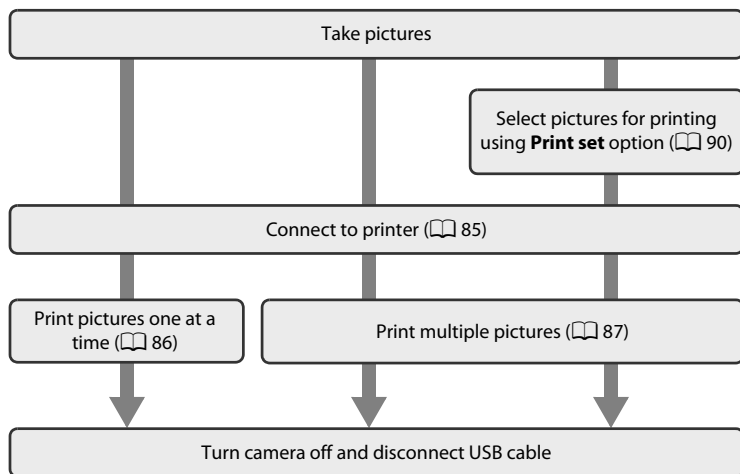

✓ Notes on Power Source

- When connecting the camera to a printer, use a fully charged battery to prevent the power from turning off unexpectedly.
- If the AC Adapter EH-62D (available separately) is used, COOLPIX S570 can be powered from a home electrical outlet. Do not use any other AC adapters as it will cause the camera to heat up or malfunction.

💡 Printing Pictures

In addition to printing pictures transferred to a computer from your personal printer and printing over a direct camera-to-printer connection, the following options are also available for printing pictures:

- Insert a memory card into a DPOF-compatible printer's card slot
- Take a memory card to a digital photo lab

For printing using these methods, specify the pictures and the number of prints each using the **Print set** in the playback menu (📖 90).

Connecting the Camera and Printer

- 1 Turn off the camera.

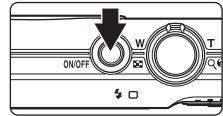

- 2 Turn on the printer.

- Check printer settings.

- 3 Connect the camera to the printer using the supplied USB cable.

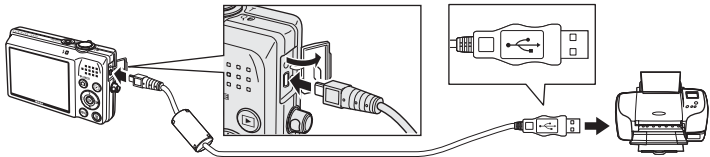

- 4 Turn on the camera.

- When connected correctly, the **PictBridge** startup screen (①) will be displayed in the camera monitor. Then the **Print selection** screen (②) will be displayed.

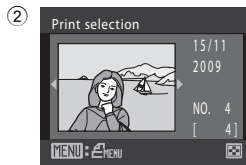
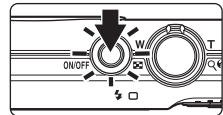

✓ Connecting the USB Cable

When connecting the USB cable, be sure that the connectors are oriented correctly. Do not use force when connecting the USB cable. When disconnecting the USB cable, do not pull the connector at an angle.

Printing Pictures One at a Time

After connecting the camera to the printer correctly (📖 85), print pictures by following the procedures below.

1 Use the multi selector to choose the desired picture and press the **OK** button.

- Rotate the zoom control to **W** (📷) to switch to 12-thumbnail display, and to **T** (📺) to switch back to full-frame playback.

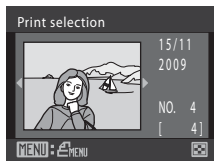

2 Choose **Copies** and press the **OK** button.

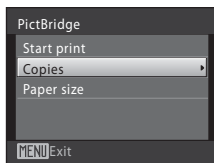

3 Choose the number of copies (up to nine) and press the **OK** button.

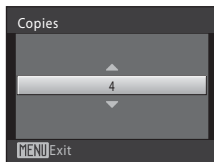

4 Choose **Paper size** and press the **OK** button.

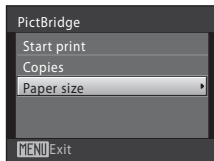

5 Choose the desired **Paper size** and press the **OK** button.

- To specify paper size using printer settings, choose **Default** in the paper size menu.

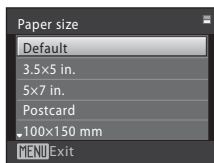

6 Choose **Start print** and press the **OK** button.

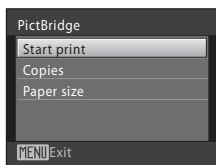

7 Printing starts.

- Monitor display returns to the print selection screen (step 1) when printing is complete.
- To cancel before all copies have been printed, press the **OK** button.

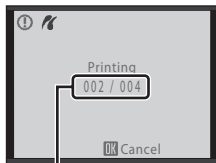

Current print/
total number of prints

Printing Multiple Pictures

After connecting the camera to the printer correctly (📖 85), print pictures by following the procedures below.

1 When the print selection screen is displayed, press the **MENU** button.

- The print menu is displayed.

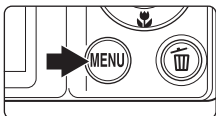

2 Use the multi selector to choose **Paper size** and press the **OK** button.

- To exit the print menu, press the **MENU** button.

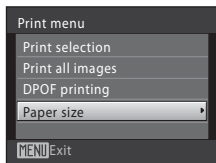

3 Choose the desired **Paper size** and press the **OK** button.

- To specify paper size using printer settings, choose **Default** in the paper size menu.

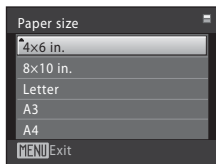

4 Choose **Print selection**, **Print all images** or **DPOF printing** and press the **OK** button.

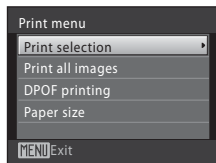

Print selection

Choose the pictures (up to 99) and the number of copies (up to nine) of each.

- Press the multi selector ◀ or ▶ to select pictures, and press ▲ or ▼ to set the number of copies for each.
- Picture selected for printing can be recognized by the check mark (✔) and the numeral indicating the number of copies to be printed. Check marks are not displayed with pictures for which no copies have been specified and these pictures will not be printed.
- Rotate the zoom control to **T** (🔍) to switch to full-frame playback.
- Rotate the zoom control to **W** (📄) to switch back to 12-thumbnail display.
- Press the **OK** button when setting is complete.
- When the menu shown at right is displayed, choose **Start print** and press the **OK** button to start printing. Choose **Cancel** and press the **OK** button to return to the print menu.

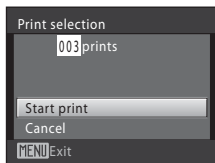

Print all images

All pictures stored in the internal memory, or on the memory card, are printed one at a time.

- When the menu shown at right is displayed, choose **Start print** and press the **OK** button to start printing.
- Choose **Cancel** and press the **OK** button to return to the print menu.

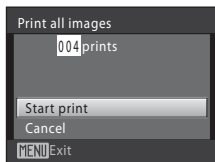

DPOF printing

Print pictures for which a print order was created in **Print set** (📖 90).

- When the menu shown at right is displayed, choose **Start print** and press the **OK** button to start printing.
- Choose **Cancel** and press the **OK** button to return to the print menu.
- To view the current print order, choose **View images** and press the **OK** button. To print pictures, press the **OK** button again.

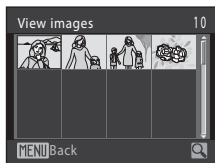
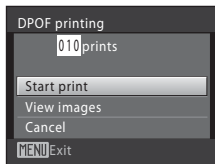
**5** Printing starts.

- Monitor display returns to the print menu (step 2) when printing is complete.
- To cancel before all copies have been printed, press the **OK** button.

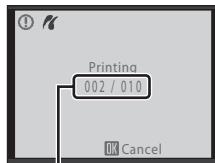

Current print/
total number of prints

📄 Paper Size

The camera supports the following paper sizes: **Default** (the default paper size for the current printer), **3.5×5 in.**, **5×7 in.**, **100×150 mm**, **4×6 in.**, **8×10 in.**, **Letter**, **A3**, and **A4**. Only sizes supported by the current printer will be displayed. To specify paper size using printer settings, choose **Default** in the paper size menu.

Creating a DPOF Print Order: Print Set

The **Print set** option in the playback menu is used to create digital “print orders” for printing on DPOF-compatible devices (📖 152).

When the camera is connected to a PictBridge-compatible printer, pictures can be printed from the printer according to the DPOF print order you have created for pictures on the memory card. If the memory card is removed from the camera, you can create the DPOF print order for pictures in the internal memory and print pictures according to the DPOF print order.

1 Press the **MENU** button in playback mode.

- The playback menu is displayed.

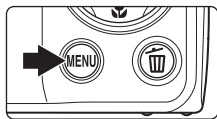

2 Use the multi selector to choose **Print set** and press the **OK** button.

- When using list by date, auto sort, or favorite pictures playback mode: Proceed to step 4

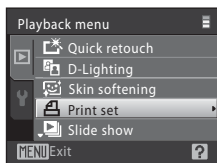

3 Choose **Select images** and press the **OK** button.

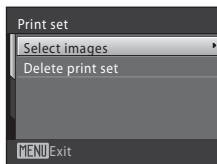

4 Choose the pictures (up to 99) and the number of copies (up to nine) for each.

- Press the multi selector ◀ or ▶ to select pictures, and press ▲ or ▼ to set the number of copies for each.
- Picture selected for printing can be recognized by the check mark (✔) icon and the numeral indicating the number of copies to be printed. Check marks are not displayed with pictures for which no copies have been specified and these pictures will not be printed.
- Rotate the zoom control to **T** (📷) to switch to full-frame playback.
- Rotate the zoom control to **W** (🖼️) to switch back to 12-thumbnail display.
- Press the **OK** button when setting is complete.

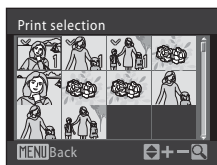

5 Choose whether or not to print shooting date and photo information.

- Choose **Date** and press the **OK** button to print the shooting date on all pictures in the print order.
- Choose **Info** and press the **OK** button to print shutter speed and aperture information on all pictures in the print order.
- Choose **Done** and press the **OK** button to complete the print order and exit.

Pictures selected for printing are recognized by the  icon displayed with playback.

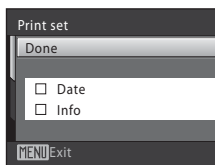

Deleting All Print Orders

Choose **Delete print set** in step 3 and press the **OK** button to delete print orders for all pictures.

Notes on the Print Set Option

When using Print set while viewing pictures by List by date, Auto sort, or Favorite pictures playback, if pictures other than the selected date or type are already set for printing, the screen shown at right will be displayed.

- If **Yes** is selected, the current settings are added to the previous settings.
- If **No** is selected, the previous settings are deleted and only the current settings remain.

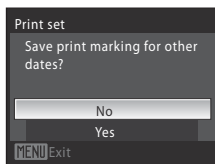

When using List by date

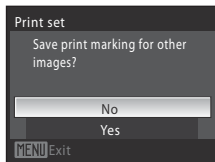

When using Auto sort/
Favorite pictures

Creating a DPOF Print Order: Print Set

If more than 99 pictures are selected as a result of adding the current settings, the screen shown at right will be displayed.

- If **Yes** is selected, the previous settings are deleted and only the current settings remain.
- If **Cancel** is selected, the current settings are deleted and only the previous settings remain.

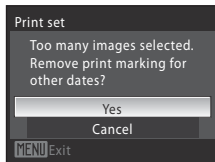

When using List by date

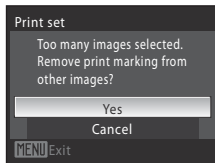

When using Auto sort/
Favorite pictures

✓ Notes on Printing Shooting Date and Photo Information

When the **Date** and **Info** options are enabled in the **Print set** menu, shooting date and photo information are printed on pictures when a DPOF-compatible (📖 152) printer which supports printing of shooting date and photo information is used.

- Photo information cannot be printed when the camera is connected directly to a printer, via the supplied USB cable, for DPOF printing (📖 89).
- **Date** and **Info** are reset each time the print set menu is displayed.
- The date and time printed on pictures with DPOF printing when **Date** in the **Print set** menu is enabled, are those recorded with the picture as it was taken. Date and time printed using this option are not affected when the camera's date and time setting are changed from the setup menu after pictures are recorded.















🔍 Date Imprint



The shooting date and time can be imprinted in pictures at the time of shooting by using **Date imprint** (📖 120) in the setup menu. This information can be printed even from printers that do not support printing of date and time. Only the date with the **Date imprint** option will be printed, even if **Print set** is enabled with **Date** selected in the print set screen.

Shooting Options: The Shooting Menu

While shooting in  (auto) mode ( 20), the shooting menu contains the following options.

	Image mode	 94
	Choose the image mode (a combination of the image size and image quality (compression)) to be used when recording. Also available when using other shooting modes (except movie mode).	
	White balance	 96
	Match white balance to the light source.	
	Continuous	 98
	Change settings for Continuous or BSS (best shot selector).	
	ISO sensitivity	 99
	Control the camera's sensitivity to light.	
	Color options	 100
	Apply color effects to pictures as they are recorded.	
	AF area mode	 101
	Choose how the focus area is determined.	

Displaying the Shooting Menu

Enter  (auto) mode ( 20).

Press the **MENU** button to display the shooting menu.

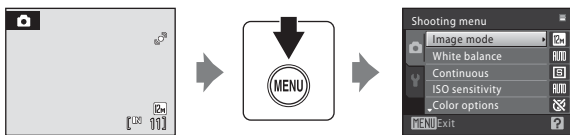

- Use the multi selector to choose and apply settings ( 9).
- To exit the shooting menu, press the **MENU** button.

Functions that Cannot Be Applied Simultaneously









Some functions cannot be enabled in conjunction with others ( 105).

Image Mode

Set to  (auto) → MENU (Shooting menu) →  Image mode

Choose an image mode, which is the combination of image size and image quality (compression), according to how you plan to use the picture and the capacity of the internal memory or memory card.

The larger the image, the larger the size at which it can be printed or displayed without becoming noticeably "grainy", limiting the number of pictures that can be recorded.

Image mode	Image size (pixels)	Description
 High (4000★)	4,000×3,000	Highest quality, suitable for enlargements or high-quality prints. The compression ratio is approximately 1:4.
 Normal (4000) (default setting)	4,000×3,000	The best choice in most situations. The compression ratio is approximately 1:8.
 Normal (3264)	3,264×2,448	
 Normal (2592)	2,592×1,944	
 Normal (2048)	2,048×1,536	Smaller size allows more pictures to be stored. The compression ratio is approximately 1:8.
 PC screen (1024)	1,024×768	Suited to display on computer monitor. The compression ratio is approximately 1:8.
 TV screen (640)	640×480	Suited to full-screen display on a television or distribution by e-mail or the web. The compression ratio is approximately 1:8.
 16:9 (3968)	3,968×2,232	Pictures with an aspect ratio of 16:9 can be taken. The compression ratio is approximately 1:8.











The icon for the current setting is displayed in the monitor in shooting and playback modes ( 6, 7).

Image Mode

- Change made to this setting applies to all shooting modes (except movie mode).
- This feature cannot be used simultaneously with certain features. → "Functions that Cannot Be Applied Simultaneously" ( 105)

Number of Exposures Remaining

The following table lists the approximate number of pictures that can be stored in internal memory and on a 512 MB memory card. Note that the number of pictures that can be stored will differ depending on the composition of the picture (due to JPEG compression). In addition, this number may differ depending on the make of memory card, even if the capacity for the memory card is the same.

Setting	Internal memory (approx. 47 MB)	Memory card ¹ (512 MB)	Print size ² (cm/in.)
 High (4000★)	5	60	34 × 25/13 × 10
 Normal (4000)	11	120	34 × 25/13 × 10
 Normal (3264)	17	190	28 × 21/11 × 8
 Normal (2592)	29	310	22 × 16/8.5 × 6.5
 Normal (2048)	48	520	17 × 13/7 × 5
 PC screen (1024)	162	1780	9 × 7/3.5 × 2.5
 TV screen (640)	280	3070	5 × 4/2 × 1.5
 16:9 (3968)	15	170	34 × 19/13 × 7.5

¹ If the number of exposures remaining is 10,000 or more, the number of exposures remaining display shows "9999".

² All figures are approximate. Print size at an output resolution of 300 dpi. Print sizes are calculated by dividing the number of pixels by printer resolution (dpi) and multiplying by 2.54 cm (1 in.). However, at the same image size, pictures printed at higher resolutions will print smaller than the size indicated, and those printed at lower resolutions will print larger than the size indicated.

WB White Balance

Set to  (auto) → MENU (Shooting menu) →  White balance

The color of light reflected from an object varies with the color of the light source. The human brain is able to adapt to changes in the color of the light source, with the result that white objects appear white whether seen in the shade, direct sunlight, or under incandescent lighting. Digital cameras can mimic this adjustment by processing images according to the color of the light source. This is known as “white balance”. For natural coloration, choose a white balance setting that matches the light source before shooting. Although the default setting, **Auto**, can be used under most types of lighting, you can apply the white balance setting suited to a particular light source to achieve more accurate results.

Auto (default setting)

White balance automatically adjusted to suit lighting conditions. Best choice in most situations.

Preset manual

Neutral-colored object used as reference to set white balance under unusual lighting conditions. Refer to “Preset Manual” for more information ( 97).

Daylight

White balance adjusted for direct sunlight.

Incandescent

Use under incandescent lighting.

Fluorescent

Use under most types of fluorescent lighting.

Cloudy

Use when taking pictures under overcast skies.

Flash

Use with the flash mode.

The effects of the selected option can be previewed in the monitor. At settings other than **Auto**, the icon for the current setting is displayed in the monitor ( 6).

White Balance

This feature cannot be used simultaneously with certain features. → “Functions that Cannot Be Applied Simultaneously” ( 105)

Flash Mode

At white-balance settings other than **Auto** or **Flash**, turn the flash off (  28).

Preset Manual

Preset manual is used with mixed lighting or to compensate for light sources with a strong color cast when the desired effect has not been achieved with white balance settings like **Auto** and **Incandescent** (for example, to make images shot under a lamp with a red shade look as though they had been shot under white light).

1 Place a white or gray reference object under the lighting that will be used during shooting.

2 Display the shooting menu (📖 93), use the multi selector to set **White balance** to **PRE Preset manual**, then press the **OK** button.

- The camera zooms in.

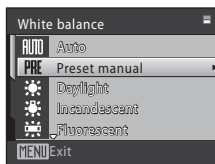

3 Choose **Measure**.

- To apply the most recently measured value for preset manual, choose **Cancel** and press the **OK** button.

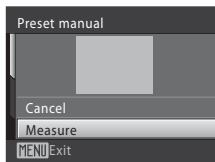

4 Frame the reference object.

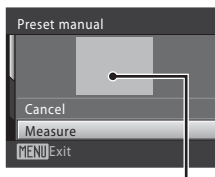

Reference object frame

5 Press the **OK** button.

- The shutter is released and the new white balance value is set (no picture is recorded).

✔ Note on Preset Manual

The camera cannot measure a white balance value for when the flash fires. When shooting with the flash, set **White balance** to **Auto** or **Flash**.

Continuous

Set to  (auto) → MENU (Shooting menu) →  Continuous

Change settings to Continuous or BSS (best shot selector). Flash will be switched off for **Continuous**, **BSS** or **Multi-shot 16**, and focus, exposure and white balance are fixed at the values for the first picture in each series.

Single (default setting)

One shot is taken each time shutter-release button is pressed.

Continuous

While the shutter-release button is held down, the camera shoots up to 5 pictures at a rate of up to about 0.9 frames per second (fps) (when image mode is set to  **Normal (4000)**).

BSS BSS (Best Shot Selector)

The “best shot selector” is recommended when shooting with the flash off or the camera zoomed in, or in other situations in which inadvertent motion can result in blurred pictures. When BSS is on, the camera takes up to ten pictures while the shutter-release button is held down. The sharpest picture in the series is automatically selected and saved.

Multi-shot 16

Each time the shutter-release button is pressed all the way down, 16 pictures are shot at about 24 frames per second and the camera arranges them in a single picture.

- Images are captured with the image mode locked at  **2592**.
- Digital zoom is not available.

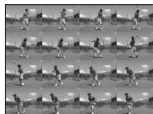

At settings other than **Single**, the indicator for the current setting is displayed in the monitor ( 6).

Note on Continuous Shooting

- The maximum frame rate with continuous shooting may vary, depending upon the current image mode setting and the memory card used.
- This feature cannot be used simultaneously with certain features. → “Functions that Cannot Be Applied Simultaneously” ( 105)

Note on BSS

BSS may not produce the desired results if the subject moves or the composition changes while the shutter-release button is pressed all the way down.

Note on Multi-shot 16

Smear ( 136) visible in the monitor when shooting with **Multi-shot 16** enabled will be recorded with images. Avoiding bright objects such as the sun, reflections of the sun, and electric lights when shooting with **Multi-shot 16** enabled is recommended.

ISO ISO Sensitivity

Set to  (auto) → MENU (Shooting menu) →  ISO sensitivity

Sensitivity is a measure of how quickly the camera reacts to light. The higher the sensitivity, the less light needed to make an exposure. Although a high ISO rating is suited for taking pictures of subjects in action or in poor lighting, high sensitivity is often associated with “noise” - randomly spaced, brightly colored pixels concentrated in dark parts of the image.

Auto (default setting)

Sensitivity is ISO 80 under normal conditions; when lighting is poor and the flash is off, the camera compensates by raising sensitivity to a maximum of ISO 1600.





Fixed range auto

Choose the range in which the camera automatically adjusts ISO sensitivity, from **ISO 80-400** (default setting), or **ISO 80-800**. The camera will not raise sensitivity beyond the maximum value in the selected range. Set the maximum value for ISO sensitivity for effective control over the amount of “grain” that appears in images.

80, 100, 200, 400, 800, 1600, 3200

Sensitivity will be locked at the specified value.

- When ISO sensitivity is locked, **Motion detection** ( 122) does not function.

At the settings other than **Auto**, the current setting is displayed in the monitor ( 6). If **Auto** is selected and the sensitivity is raised above ISO 80, the  icon will be displayed ( 29). When set to **Fixed range auto**,  and the upper limit of the ISO sensitivity is displayed.





Notes on ISO Sensitivity

This feature cannot be used simultaneously with certain features. → “Functions that Cannot Be Applied Simultaneously” ( 105)

Color Options

Set to  (auto) → MENU (Shooting menu) →  Color options

Make colors more vivid or record pictures in monochrome.

-  **Standard color (default setting)**
Use for pictures exhibiting natural color.
-  **Vivid color**
Use to achieve a vivid, “photoprint” effect.
-  **Black-and-white**
Record pictures in black-and-white.
-  **Sepia**
Record pictures in sepia tones.
-  **Cyanotype**
Record pictures in cyan-blue monochrome.

The effects of the selected option can be previewed in the monitor ( 6). At settings other than **Standard color**, the icon for the current setting is displayed in the monitor.

Notes on Color Options

This feature cannot be used simultaneously with certain features. → “Functions that Cannot Be Applied Simultaneously” ( 105)

[+/-] AF Area Mode

Set to (auto) → MENU (Shooting menu) → [+/-] AF area mode

Choose how the focus area is determined.

When digital zoom is in effect, focus will be on the center of the screen regardless of the **AF area mode** setting.

Face priority (default setting)

If the camera detects a face, it focuses on the face (Face Priority → 103). If more than one face is recognized, focus will be on the face closest to the camera.

When shooting pictures of subjects other than people, or framing a subject with which no face is recognized, **AF area mode** will switch to **Auto**, and the camera will automatically select the focus area (one of nine) containing the subject closest to the camera.



Auto

The camera automatically selects the focus area (one of nine) containing the subject closest to the camera. Press the shutter-release button halfway to activate the focus area. When the shutter-release button is pressed halfway, the focus area selected by the camera will be displayed in the monitor.

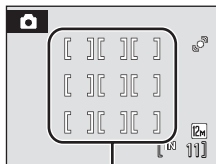

Focus areas

[+/-] Manual

This option is suited to situations in which the intended subject is relatively still and not positioned in the center of the frame.

Press the multi-selector , , , or to select from 99 focus areas in the frame. Pictures can be taken while focus-area selection screen is displayed.

To end focus-area selection and adjust the flash, macro, self-timer and exposure compensation settings, press the button. To return to the focus area selection screen, press the button again.

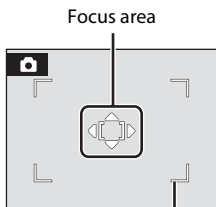

Selectable focus area

Center

The camera focuses on the subject in the center of the frame.
The center focus area is always displayed.

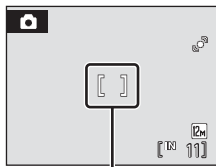

Focus area

Focus Lock

Use focus lock to focus on off-center subjects when center is selected for AF area mode.

To focus on off-center subjects when **Center** is selected for **AF area mode**, use focus lock as described below.

- 1 Position the subject in the center of the frame.
- 2 Press the shutter-release button halfway.
 - Confirm that the focus area is green.
 - Focus and exposure are locked.
- 3 Continue holding down the shutter-release button halfway and recompose the picture.
 - Be sure that the distance between the camera and the subject does not change.
- 4 Press the shutter-release button the rest of the way down to take the picture.



More Information

See "Autofocus" (📖 25) for more information.

Face Priority

When the camera is pointed at a face, the face is automatically detected and the camera focuses on the face.

Face priority functions in the following situations.

- When AF area mode is set to **Face priority** (default setting) (📖 101)
- When scene mode is set to **Scene auto selector** (📖 34), **Portrait** (📖 34), or **Night portrait** (📖 35)
- When using smart portrait mode (📖 47)

1 Frame a picture.

- When the camera detects a face, that face will be framed by a yellow double border.



- When the camera detects more than one face, operation varies, depending upon the shooting mode, as follows.

Shooting mode	Faces framed by a double border	The number of faces to be recognized
📷 (auto) mode (Face priority) Scene mode: Scene auto selector, Portrait, Night portrait	The face closest to the camera * The other faces are framed by a single border.	Up to 12
Smart portrait mode	The face closest to the center of the frame * The other faces are framed by a single border.	Up to 3

2 Press the shutter-release button halfway.

- Focus will be on the face framed by the double border. The double border will glow green once focus has been locked.
- When the camera is unable to focus, the double border will blink. Press the shutter-release button halfway again and focus.
- Press the shutter-release button the rest of the way down to take the picture.
- When using smart portrait mode, even if the shutter-release button is not pressed, the shutter is released automatically if the camera detects that the face framed by the double border is smiling (**Smile timer**) (📖 49).



Notes on Face priority

- In **Face priority**, if the shutter-release button is pressed halfway when no faces are recognized, AF area mode will be set to **Auto**.
- If no face is detected when the shutter-release button is pressed halfway in **Portrait** or **Night portrait** scene mode, or Smart portrait mode, the camera will focus on the subject in the center focus area.
- Depending on shooting conditions, such as whether or not the subject is facing the camera, faces may not be detected.
The camera may be unable to detect faces in the following situations:
 - When faces are partially hidden by sunglasses or other obstructions
 - When faces take up too much or too little of the frame
- When there are multiple people in the frame, the face on which the camera focuses depends on a variety of shooting conditions, such as whether or not the subject is facing the camera.
- In some rare cases, the subject may not be in focus despite the fact that the double border glows green (📖 25). Should this occur, switch to  (auto) mode and set **AF area mode** to **Manual** or **Center**, refocus on another subject positioned at the same distance from the camera as the actual portrait subject, and use focus lock (📖 102).
- Images that were taken using face priority will be rotated and displayed automatically according to the orientation of the faces detected, in full-frame and thumbnail playback modes (excluding pictures that were shot using **Continuous**, **BSS** and **Multi-shot 16** (📖 98)).











Functions that Cannot Be Applied Simultaneously

Certain settings in the shooting menu cannot be used with other functions.

Restricted Functions	Setting	Description
Flash mode	Continuous (📖 98)	If set to Continuous , BSS , or Multi-shot 16 , the flash cannot be used.
Image mode	Continuous (📖 98)	When using Multi-shot 16 , Image mode is fixed at Normal (2592) .
Continuous	Self-timer (📖 30)	When using the self-timer, the setting is fixed at Single .
ISO sensitivity	Continuous (📖 98)	When using Multi-shot 16 , ISO sensitivity is set automatically according to the brightness.
Electronic VR	ISO Sensitivity (📖 99)	When ISO sensitivity is set to any setting other than Auto , Electronic VR does not function.
White balance	Color options (📖 100)	When using Black-and-white , Sepia , or Cyanotype , the White balance setting is fixed at Auto .
Motion detection	Continuous (📖 98)	When Multi-shot 16 is selected, Motion detection is not enabled.
	ISO sensitivity (📖 99)	When the option other than Auto is selected for ISO sensitivity, Motion detection is disabled.
Blink warning	Continuous (📖 98)	If set to Continuous , BSS , or Multi-shot 16 , blink warning cannot be used.

Playback Options: The Playback Menu

The following options are available in playback mode.

 Quick retouch 📖 70	
Easily create retouched copies in which contrast and saturation have been enhanced.	
 D-Lighting 📖 71	
Enhances brightness and contrast in dark portions of pictures.	
 Skin softening 📖 72	
Make the subject's skin appear smoother.	
 Print set 📖 90	
Select pictures to print and the number of copies for each.	
 Slide show 📖 108	
View pictures stored in the internal memory or on a memory card in an automatic slide show.	
 Delete 📖 109	
Delete all or selected pictures.	
 Protect 📖 109	
Protect selected pictures from accidental deletion.	
 Rotate image 📖 110	
Change the orientation of pictures.	
 Small picture 📖 73	
Create a small copy of the current picture.	
 Voice memo 📖 66	
Record voice memos for pictures after they are taken.	
 Copy 📖 110	
Copy files between memory card and internal memory.	

Displaying the Playback Menu

Enter the playback mode by pressing the  button (📖 26).

Press the **MENU** button to display the playback menu.

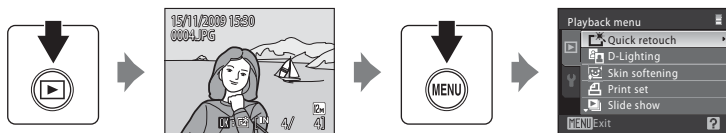

- Use the multi selector to choose and apply settings (📖 9).
- To exit the playback menu, press the **MENU** button.

Selecting Pictures

The picture selection screen, as shown at right, will be displayed with the following menus:

- **Playback menu:** **Print set>Select images**
(📖 90)
Delete>Erase selected images
(📖 109)
Protect (📖 109)
Rotate image (📖 110)
Copy>Selected images (📖 110)
- **Setup menu:** **Welcome screen** (📖 115)





Follow the procedures described below to choose the pictures.

- 1** Press the multi selector ◀ or ▶ to choose the desired picture.
 - Only one picture can be selected for **Rotate image** and **Welcome screen**. Proceed to step 3.
 - Rotate the zoom control to **T** (📷) to switch to full-frame playback. Rotate the zoom control to **W** (📐) to switch back to 12-thumbnail display.
- 2** Press ▲ or ▼ to select **ON** or **OFF** (or the number of copies).
 - When **ON** is selected, a check mark (☑) is displayed in the top left corner of the current picture. Repeat steps 1 and 2 to select additional pictures.
- 3** Press the (OK) button to apply picture selection.





Slide Show

Press the  button (Playback mode) → MENU (Playback menu) →  Slide show

View pictures stored in the internal memory or on a memory card in an automatic slide show.

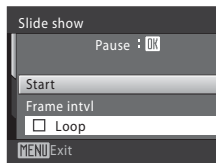

1 Use the multi selector to choose **Start** and press the button.

- To change the interval between pictures, choose **Frame intvl**, select the desired interval time, and press the  button before choosing **Start**.
- To repeat the slide show automatically, enable **Loop** and press the  button before choosing **Start**. The check mark () will be added to the loop option when enabled.



2 The slide show begins.

While the slide show is in progress, the following operations are available:

- Press the multi selector  to display the subsequent picture or  to display the previous picture. Hold down either button to fast forward or rewind.
- Press the  button to pause the slide show.





3 Choose **End** or **Restart**.

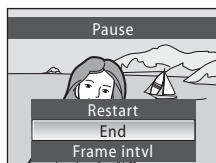

- When the slide show ends or is paused, choose **End** and press the  button to return to the playback menu, or choose **Restart** to play the slide show again.



Notes on Slide Show

- Only the first frame of movies ( 78) included in slide shows is displayed.
- Even if **Loop** is selected, the maximum playback duration for a slide show is 30 minutes ( 124).

Delete

Press the  button (Playback mode) → MENU (Playback menu) →  Delete

Delete selected pictures or all pictures.

Erase selected images

Delete selected pictures (See “Selecting Pictures” ( 107) for more information).



Erase all images

Delete all pictures.

Notes on Deletion

- Once deleted, pictures cannot be recovered. Transfer important images to a computer before deletion.
- Pictures marked with the  icon are protected and cannot be deleted.



Protect

Press the  button (Playback mode) → MENU (Playback menu) →  Protect

Protect selected pictures from accidental deletion.

Choose pictures in the picture selection screen to apply the protect option (Selecting Pictures →  107).

Note, however, that formatting the camera’s internal memory or the memory card will permanently erase protected files ( 125).



Protected pictures are recognized by the  icon ( 7, 50).

Rotate Image

Press the  button (Playback mode) → MENU (Playback menu) →  Rotate image

After shooting, set the orientation in which pictures are displayed during playback. Pictures can be rotated 90° clockwise or counterclockwise.

Pictures that were recorded in the portrait (vertical) orientation can be rotated up to 180° in either direction.

Select a picture in the picture selection screen (107), and press the  button to display the Rotate image screen. Press the multi selector  or  to rotate the picture 90°.

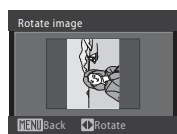

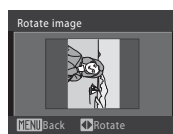
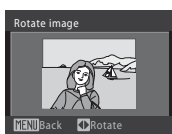

Rotate 90°
counterclockwise



Rotate 90° clockwise





Press the  button to set the orientation displayed, and save the orientation data with the picture.

Copy

Press the  button (Playback mode) → MENU (Playback menu) →  Copy

Copy pictures between the internal memory and a memory card.

1 Select an option from the copy screen using the multi selector and press the  button.

-  → : Copy pictures from internal memory to memory card.
-  → : Copy pictures from memory card to internal memory.

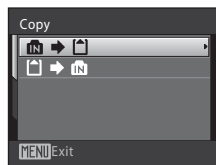

2 Select a copy option and press the **OK** button.

- **Selected images:** Copy pictures selected from the picture selection screen (📖 107).
- **All images:** Copy all pictures.

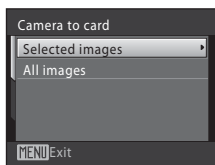

✓ Notes on Copying Pictures

- JPEG-, AVI-, and WAV-format images can be copied. Images recorded in any other formats cannot be copied.
- If voice memos (📖 66) are attached to pictures selected for copying, voice memos are copied with the pictures.
- Pictures taken with another make of camera or that have been modified on a computer cannot be copied.
- When copying pictures for which **Print set** (📖 90) options are enabled, the print set settings will not be copied. However, when copying pictures for which **Protect** (📖 109) is enabled, the protect setting will be copied.
- Pictures copied from the internal memory or a memory card cannot be displayed in auto sort mode (📖 56).
- Even if a picture added to favorites folder (📖 61) is copied, the contents of the favorites folder will not be copied.

✍ Memory contains no images. Message

















If there are no pictures stored on the memory card when playback mode is applied, the message **Memory contains no images.** will be displayed. Press the **MENU** button to display the copy option screen, and copy the pictures stored in the camera's internal memory to the memory card.

💡 More Information

See "File and Folder Names" (📖 132) for more information.

Basic Camera Setup: The Setup Menu

The setup menu contains the following options.

	Menus 📖 114
	Choose how menus are displayed.
	Welcome screen 📖 115
	Select screen displayed when the camera is turned on.
	Date 📖 116
	Set the camera clock and choose home and destination time zones.
	Monitor settings 📖 119
	Choose whether or not to display information in the monitor, whether or not pictures are shown on the display for review after taking them, and set the monitor brightness.
	Date imprint 📖 120
	Imprint date on pictures.
	Electronic VR 📖 121
	Specify the electronic vibration reduction setting for taking still pictures.
	Motion detection 📖 122
	Adjust the motion detection setting to reduce the effects of subject movement and camera shake when taking still pictures.
	AF assist 📖 123
	Enable or disable AF-assist illumination.
	Digital zoom 📖 123
	Adjust settings for using digital zoom.
	Sound settings 📖 124
	Adjust sound settings.
	Auto off 📖 124
	Set the time before the camera enters standby mode to save power.
	Format memory/Format card 📖 125
	Format internal memory or memory card.
	Language 📖 126
	Choose the language used for camera monitor display.
	Video mode 📖 126
	Adjust settings necessary for connection to television.
	Blink warning 📖 126
	Choose whether or not to detect blinking human subjects when shooting pictures using face priority.
	Reset all 📖 128
	Restore camera settings to default values.

Ver: Firmware version

📖 130

Display camera firmware version.

Displaying the Setup Menu

Choose **Y** tab in the menu screen.**1** Press the **MENU** button to display the menu screen.

- When using **📷** (auto) mode, smart portrait mode, playback mode, and movie mode
- When using scene mode

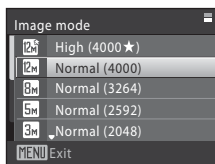
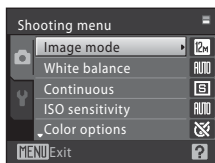
**2** Press the multi selector **◀**.

- For information on using the multi selector, see “The Multi Selector” (📖 9).
- Tab will be selectable.

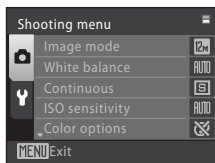
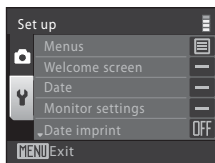
**3** Press **▲** or **▼** to select the **Y** tab.

4 Press **▶** or the **OK** button.

- The setup menu items are selectable.
- Use the multi selector to choose and apply settings (📖 9).
- To exit the setup menu, press the **MENU** button or **◀** to select other tabs.

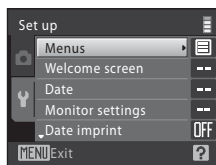

MENU Menus

Press the **MENU** button → **Y** (Setup menu) (📖 113) → **MENU** Menus

Choose how menus are displayed.

Text (default setting)

Menus are displayed in list format.

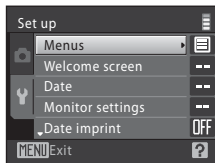

Icons

All menu items can be displayed in a single page.

Menu names

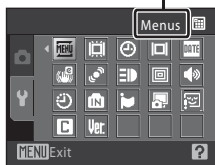

Welcome Screen

Press the **MENU** button →  (Setup menu) (📖 113) →  Welcome screen

You can select the welcome screen to be displayed when the camera is turned on.

None (default setting)

No welcome screen will be displayed.

COOLPIX

Displays a welcome screen.

Select an image

Select a picture in the internal memory or on the memory card for the welcome screen. Choose a picture in the picture selection screen (📖 107) and press the  button.

As the selected image is stored in the camera, the image will appear in the welcome screen even if the original picture is deleted.

- Pictures taken at an **Image mode** setting of **16:9** (📖 94), and copies created at a size of 320 × 240 or smaller using the small picture (📖 73) or crop (📖 74) function, cannot be used.

Date





Press the **MENU** button →  (Setup menu) (📖 113) →  Date

Set the camera's internal clock.



Date

Set the camera clock to the current date and time.

Use the multi selector to set the date and time.

- Highlight an item (day, month, year, hour, minute, and the order in which day, month, and year are displayed): Press  or .
- Edit the highlighted item: Press  or .
- Finish setting: After selecting the order in which the day, month, and year are displayed, press the  button (📖 17).

Time zone

 (home time zone) can be specified and daylight saving enabled or disabled from **Time zone** options. When  (travel destination) is selected, the time difference (📖 118) is automatically calculated and the date and time in the selected region are recorded. Useful when travelling.

Setting Travel Destination Time Zone

1 Use the multi selector to choose **Time zone** and press the  button.

- The **Time zone** menu is displayed.

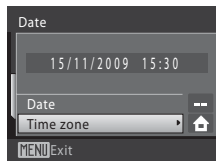

2 Choose  **Travel destination** and press the  button.

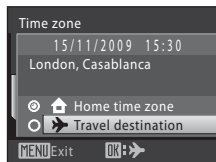

- The date and time displayed on the monitor change according to the region currently selected.

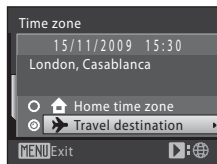

3 Press **▶**.

- The time zone selection screen is displayed.

**4** Press **◀** or **▶** to choose the travel destination region (time zone).

- If the daylight saving time is in effect, press **▲** to turn on the daylight saving time option. When the option is enabled,  is displayed at the top of the monitor, and the time is advanced one hour. To turn off the daylight saving time option, press **▼**.
- Press the **OK** button to choose the travel destination time zone.
- While the travel destination time zone is selected, the  icon will be displayed in the monitor when the camera is in shooting mode.

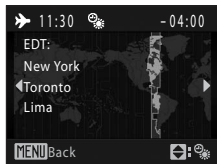
**✓ The Clock Battery**

The camera's internal clock uses a backup battery that is independent from the camera's battery. The clock battery charges when the main battery is installed or an AC adapter is connected, and can provide several days of backup power after about ten hours of charging.

📌 Home Time Zone

- To switch to the home time zone, choose **🏠 Home time zone** in step 2 and press the **OK** button.
- To change the home time zone, choose **🏠 Home time zone** in step 2 and perform steps 3 and 4, to set the home time zone.

📌 Daylight Saving Time

When daylight saving time starts or ends, turn the daylight saving time option on or off from the time zone selection screen displayed in step 4.

📌 Imprinting the Date on Pictures

After setting the date and time, set the **Date imprint** setting in the setup menu (📖 120). Once **Date imprint** is set, the shooting date and time can be imprinted on the image data when taking pictures.

Time Zones

The camera supports the time zones listed below. For time differences not listed below, set the camera clock to local time.

UTC +/-	Location	UTC +/-	Location
-11	Midway, Samoa	+1	Madrid, Paris, Berlin
-10	Hawaii, Tahiti	+2	Athens, Helsinki, Ankara
-9	Alaska, Anchorage	+3	Moscow, Nairobi, Riyadh, Kuwait, Manama
-8	PST (PDT): Los Angeles, Seattle, Vancouver	+4	Abu Dhabi, Dubai
-7	MST (MDT): Denver, Phoenix	+5	Islamabad, Karachi
-6	CST (CDT): Chicago, Houston, Mexico City	+5.5	New Delhi
-5	EST (EDT): New York, Toronto, Lima	+6	Colombo, Dhaka
-4	Caracas, Manaus	+7	Bangkok, Jakarta
-3	Buenos Aires, Sao Paulo	+8	Beijing, Hong Kong, Singapore
-2	Fernando de Noronha	+9	Tokyo, Seoul
-1	Azores	+10	Sydney, Guam
±0	London, Casablanca	+11	New Caledonia
		+12	Auckland, Fiji

Monitor Settings

Press the MENU button →  (Setup menu) (📖 113) →  Monitor settings

The following settings are available.

Photo info

Choose information displayed in the monitor during shooting and playback mode.

Image review

- **On** (default setting): Picture is automatically displayed in the monitor immediately after it is taken and the monitor display returns to shooting mode.
- **Off**: Picture is not displayed after it is taken.





Brightness

Choose from five settings for monitor brightness. The default setting is **3**.

Photo Info

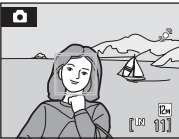
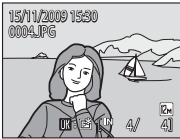
The following display options are available.

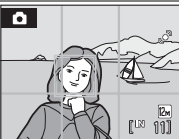
See “The Monitor” (📖 6) for information on indicators in the monitor.

	Shooting mode	Playback mode
Show info		
Auto info (default setting)	The current settings or operation guide is displayed for a few seconds, as in Show info above. After a few seconds, display will be the same as Hide info .	
Hide info		
Framing grid + Auto info	 In  (auto) mode, a framing grid is displayed to help frame pictures; other current settings or operation guide is displayed for a few seconds, as in Auto info above. In other shooting modes, the current settings or operation guide is displayed, as in Auto info above.	 The current settings or operation guide is displayed, as in Auto info above.

DATE Date Imprint

Press the **MENU** button → **Y** (Setup menu) (📖 113) → **DATE** Date imprint

The shooting date and time can be imprinted in pictures at the time of shooting. This information can be printed even from printers that do not support printing of date and time (📖 92).



Off (default setting)

Date and time are not imprinted on pictures.

Date

The date is imprinted in pictures.

Date and time

The date and time are imprinted in pictures.

At settings other than **Off**, the icon for the current setting is displayed in the monitor (📖 6).



✓ Date Imprint

- Imprinted dates form a permanent part of image data and cannot be deleted. Date cannot be imprinted on pictures after they are taken.
- Dates imprinted at an **Image mode** setting (📖 94) of **TV screen (640)** may be difficult to read. Choose **PC screen (1024)** or larger when using date imprint.
- The date is recorded using the format selected in the setup menu's **Date** item (📖 16, 116).
- The date is not imprinted in the following situations:
 - When using the **Panorama assist** scene mode
 - Movie mode

📎 Date Imprint and Print Set

When printing from DPOF-compatible printers which support printing of shooting date and photo information, the date and information can be printed on pictures without date and time imprinted on them, using options in the **Print set** menu (📖 90).

Electronic VR

Press the **MENU** button →  (Setup menu) (📖 113) →  Electronic VR

Choose whether to use electronic VR (vibration reduction) when taking still pictures.

Auto

When all of the following conditions are met while taking still pictures, electronic VR is applied and the effects of camera shake are reduced.

- The flash is turned off or set to slow sync mode.
- The shutter speed is slow.
- The **Continuous** setting is set to **Single**.
- When the subject is dark.

Off (default setting)

Electronic VR is disabled.

When **Auto** is selected,  appears on the monitor (📖 6), and electronic VR is applied depending on shooting conditions.

Notes on Electronic Vibration Reduction

- Electronic VR is disabled while the flash is used, except when using slow sync mode. Note that Electronic VR is disabled even when the flash mode is slow sync with red-eye reduction.
- If the exposure period exceeds a certain period of time, **Electronic VR** will not function.
- Electronic VR does not function when **ISO sensitivity** is set to any setting other than **Auto**.
- Electronic VR does not function when using the following scene modes.
 - Sports (📖 35)
 - Night portrait (📖 35)
 - Dusk/dawn (📖 37)
 - Night landscape (📖 37)
 - Museum (📖 38)
 - Fireworks show (📖 39)
 - Backlight (📖 39)
- The effectiveness of **Electronic VR** decreases as camera shake increases.
- Pictures taken using motion detection may be somewhat grainy.

Electronic VR for Movies

To compensate for vibration while shooting a movie, go to the movie menu (📖 76) and enable **Electronic VR** (📖 77).

Motion Detection



Press the **MENU** button →  (Setup menu) (📖 113) →  Motion detection

Enable motion detection to reduce the effects of subject movement and camera shake when shooting still pictures.

Auto (default setting)

When the camera detects the camera shake or subject movement, the shutter speed will be increased for reducing the effects of them.

However, motion detection does not function in the following situations.

- When the flash mode is set to  (fill flash)
- When **ISO sensitivity** (📖 99) is set to **Fixed range auto** or ISO sensitivity is fixed at a particular value in  (auto) mode
- When **Multi-shot 16** (📖 98) is enabled
- In the following scene modes: **Dusk/dawn** (📖 37) and **Fireworks show** (📖 39)

Off

Motion detection is not enabled.

The motion detection setting can be confirmed in the monitor while shooting (📖 6, 21).

The motion detection icon will glow green when the camera detects any vibration and increases the shutter speed. When **Off** is selected, the icon for the current setting is not displayed.

Notes on Motion Detection

- Motion detection may be unable to completely eliminate the effects of the subject movement and camera shake in some situations.
- Motion detection may not function if the subject exhibits significant movement or is too dark.
- Pictures taken using motion detection may be somewhat grainy.

AF Assist

Press the **MENU** button → **Y** (Setup menu) (📖 113) →  AF assist

Enable or disable AF-assist illumination.

Auto (default setting)

AF-assist illumination will be used to assist the focus operation when the subject is poorly lit. The illuminator has a range of about 1.9 m (6 ft. 3 in.) at the maximum wide-angle position and about 1.1 m (3 ft. 7 in.) at the maximum telephoto position. However, note that for some scene modes, AF-assist illumination turns off automatically (📖 34 to 40) even if **Auto** is set.

Off

Disable this function. The camera may be unable to focus if lighting is poor.

Digital Zoom

Press the **MENU** button → **Y** (Setup menu) (📖 113) →  Digital zoom

Adjust settings for using digital zoom.

On (default setting)

When the camera is zoomed in to the maximum optical zoom position, rotating the zoom control to **T** (📖) triggers digital zoom (📖 23).

Off

Digital zoom will not be activated (except when shooting a movie).

Notes on Digital Zoom

- When digital zoom is in effect, **AF area mode** is set to **Center** (📖 101).
- Digital zoom cannot be used in the following situations.
 - When **Scene auto selector**, **Portrait**, or **Night portrait** is selected in scene mode
 - When smart portrait mode is selected
 - When **Multi-shot 16** (📖 98) is selected
 - Just before recording a movie (Up to 2x zoom can be activated while recording movies)

Sound Settings

Press the MENU button →  (Setup menu) ( 113) →  Sound settings

Adjust the following sound settings.

Button sound

Turn button sound **On** or **Off**.

When **On** (default setting) is selected, a beep will sound once when operations are completed successfully, twice when focus has been locked, and three times when an error is detected. Start-up sound will also play when the camera is turned on.

Shutter sound

Choose shutter sound from **On** (default setting) or **Off**.

Auto Off

Press the MENU button →  (Setup menu) ( 113) →  Auto off

When the camera is on and a period of time passes without any operations having been performed, the camera will enter standby mode ( 15) to save power.

Once the camera has entered standby mode, the power-on lamp will blink, and if no operations are performed for another three minutes, the camera will turn off.

Choose the time allowed to elapse before the camera enters standby mode if no operations are performed from **30 s**, **1 min** (default setting), **5 min**, and **30 min**.

Canceling Standby Mode

Cancel standby mode and reactivate the monitor by pressing any of the following buttons.

- the power switch
- the shutter-release button
- the  button
- the  button

Note on Auto Off

Regardless of the option selected, the monitor will remain on for three minutes when menus are displayed, a maximum of 30 minutes during slide show playback, and 30 minutes when the AC adapter is connected.

Format Memory/ **Format Card**

Press the **MENU** button →  (Setup menu) ( 113) →  **Format memory**/ **Format card**

Use this option to format the internal memory or a memory card.

Formatting the Internal Memory

To format the internal memory, remove the memory card from the camera.

The **Format memory** option appears in the setup menu.

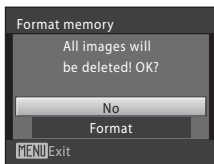

Formatting a Memory Card

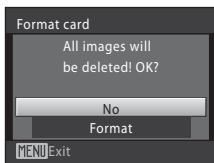

When the memory card is inserted in the camera, the **Format card** option appears in the setup menu.



Formatting Internal Memory and Memory Cards

- Formatting the internal memory or memory cards permanently deletes all data. Be sure to transfer important pictures to a computer before formatting.
- Formatting the internal memory or memory card restores favorites folder icon settings ( 60) to the default setting (displayed as number).
- Do not turn the camera off, or open the battery-chamber/memory card slot cover during formatting.
- The first time you insert the memory cards used in other devices into the COOLPIX S570, be sure to format them using this camera.

Language



Press the **MENU** button →  (Setup menu) (📖 113) →  Language

Choose one of 24 languages for display of camera menus and messages.

Čeština	Czech
Dansk	Danish
Deutsch	German
English	(default setting)
Español	Spanish
Ελληνικά	Greek
Français	French
Indonesia	Indonesian
Italiano	Italian
Magyar	Hungarian
Nederlands	Dutch
Norsk	Norwegian



Polski	Polish
Português	Portuguese
Русский	Russian
Suomi	Finnish
Svenska	Swedish
Türkçe	Turkish
中文简体	Simplified Chinese
中文繁體	Traditional Chinese
日本語	Japanese
한국말	Korean
ภาษาไทย	Thai
عربي	Arabic

Video Mode

Press the **MENU** button →  (Setup menu) (📖 113) →  Video mode

Adjust settings for connection to a television. Choose from **NTSC** and **PAL**.

Blink Warning

Press the **MENU** button →  (Setup menu) (📖 113) →  Blink warning

Choose whether or not blinking eyes are detected when using face priority (📖 103) in the following shooting modes.

-  (auto) mode (when AF area mode is set to **Face priority** (📖 101))
- When scene mode is set to **Scene auto selector** (📖 34), **Portrait** (📖 34), or **Night portrait** (📖 35)

On

When the camera detects that one or more human subjects may have closed eyes shortly after recognizing the faces and shooting them, the blink warning screen will appear in the monitor.

The face of a portrait subject, whose eyes may have been closed when the shutter was released, is framed by a yellow border. Should this occur, check the picture and decide whether or not another picture should be taken.

See "Operating the Blink Warning Screen" (📖 127) for more information.

Off (default setting)

Blink warning is not enabled.

✔ Note on Blink warning

When continuous is set to **Continuous**, **BSS**, or **Multi-shot 16**, blink warning does not function.

Operating the Blink Warning Screen

The following operations can be performed when the **Did someone blink?** screen is displayed.

If no operations are performed for a few seconds, the camera automatically returns to shooting mode.



Option	Use	Description
Enlarge and display the detected face	T (Q)	Rotate the zoom control to T (Q).
Switch to full-frame playback	W (📐)	Rotate the zoom control to W (📐).
Select the face to display		If the camera detects more than one human subjects with their eyes closed, press ▲, ▼, ◀, or ▶ during the enlarged display to switch over the faces.
Delete the picture		Press the button.
Switch to shooting mode		Press the button or the shutter-release button.

Reset All

Press the MENU button →  (Setup menu) (📖 113) →  Reset all

When **Reset** is selected, the camera's settings will be restored to their default values.

Pop-up Menu

Option	Default value
Flash mode (📖 28)	Auto
Self-timer (📖 30)	Off
Macro mode (📖 31)	Off
Exposure compensation (📖 32)	0.0

Scene Mode

Option	Default value
Scene mode setting in the shooting-mode selection menu (📖 33)	Scene auto selector
White balance in Food mode (📖 43)	Center

Smart portrait Menu

Option	Default value
Skin softening (📖 48)	Normal
Smile timer (📖 49)	On
Blink proof (📖 49)	Off

Movie Menu

Option	Default value
Movie options (📖 76)	TV movie 640★
Autofocus mode (📖 77)	Single AF
Electronic VR (📖 77)	Off

Shooting Menu

Option	Default value
Image mode (📖 94)	📷 Normal (4000)
White balance (📖 96)	Auto
Continuous (📖 98)	Single
ISO sensitivity (📖 99)	Auto
Color options (📖 100)	Standard color
AF area mode (📖 101)	Face priority

Setup Menu

Option	Default value
Menus (📖 114)	Text
Welcome screen (📖 115)	None
Photo info (📖 119)	Auto info
Image review (📖 119)	On
Brightness (📖 119)	3
Date imprint (📖 120)	Off
Electronic VR (📖 121)	Off
Motion detection (📖 122)	Auto
AF Assist (📖 123)	Auto
Digital zoom (📖 123)	On
Button sound (📖 124)	On
Shutter sound (📖 124)	On
Auto off (📖 124)	1 min
Blink warning (📖 126)	Off

Others

Option	Default value
Paper size (📖 86, 87)	Default
Slide show (📖 108)	3 s

- Choosing **Reset all** also clears the current file number (📖 132) from the memory. Numbering will continue from the lowest number available. To reset file numbering to "0001", delete all pictures (📖 109) before selecting **Reset all**.
- The following menu settings will remain unaffected when menus are reset with **Reset all**.

Shooting menu: Preset manual data (📖 97) acquired for **White balance**

Setup menu: Picture selected for **Welcome screen** (📖 115), **Date** (📖 116), **Language** (📖 126), and **Video mode** (📖 126)

Ver. Firmware Version

Press the MENU button → Y (Setup menu) (📖 113) → Ver. Firmware version

View the current camera firmware version.

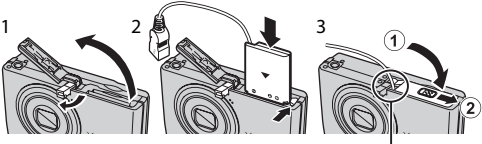

Optional Accessories

Rechargeable battery	Rechargeable Li-ion Battery EN-EL10
Battery charger	Battery Charger MH-63
AC adapter	<p>AC Adapter EH-62D</p> <p><How to attach EH-62D></p>  <p>Check that the AC adapter cord has been inserted correctly into the battery chamber before closing the battery-chamber/memory card slot cover. If part of the cord has not been inserted into the chamber the cover may be damaged during closure.</p>
USB cable	USB Cable UC-E6
AV cable	Audio Video Cable EG-CP14

Approved Memory Cards

The following Secure Digital (SD) memory cards have been tested and approved for use in this camera.

All cards of the designated make and capacity can be used, regardless of speed.

SanDisk	512 MB, 1 GB, 2 GB ¹ , 4 GB ² , 8 GB ² , 16 GB ²
TOSHIBA	512 MB, 1 GB, 2 GB ¹ , 4 GB ² , 8 GB ² , 16 GB ²
Panasonic	512 MB, 1 GB, 2 GB ¹ , 4 GB ² , 8 GB ² , 16 GB ²
Lexar	1 GB, 2 GB ¹ , 4 GB ² , 8 GB ²

¹ If the memory card will be used with a card reader or similar device, check that the device supports 2 GB cards.

²  SDHC compliant.

If the memory card will be used with a card reader or similar device, check that device supports SDHC.

Operation is not guaranteed with other makes of card. Contact the manufacturer for details on the above cards.

File and Folder Names

Pictures, movies, and voice memos are assigned file names as follows.

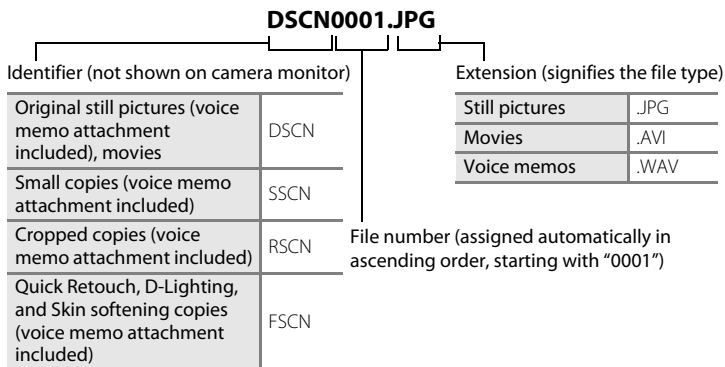

- Files are stored in folders named with a folder number followed by a five-character identifier: "P_" plus a three-digit sequence number for pictures shot using **Panorama assist** (e.g. "101P_001"; 📖 45), and "NIKON" for all other pictures (e.g. "100NIKON"). When the number of files within a folder reaches 9999, a new folder will be created. File numbers will be assigned automatically starting with "0001".
- Voice memo file names have the same identifier and file number as the picture to which the voice memo is attached.
- Files copied using **Copy > Selected images** is copied to the current folder, where they are assigned new file numbers in ascending order starting from the largest file number in memory. **Copy > All images** copies all folders from the source medium; file names do not change but new folder numbers are assigned in ascending order, starting from the largest folder number on the destination medium (📖 110).
- A single folder can hold up to 200 pictures; if the current folder already contains 200 pictures, a new folder, named by adding one to the current folder name, will be created the next time a picture is taken. If the current folder is numbered 999 and contains 200 pictures, or a picture is numbered 9999, no further pictures can be taken until the internal memory or memory card is formatted (📖 125), or a new memory card is inserted.

Caring for the Camera

To ensure continued enjoyment of this Nikon product, observe the following precautions when using or storing the device.

Keep dry

The device will be damaged if immersed in water or subjected to high humidity.

Do not drop

The product may malfunction if subjected to strong shock or vibration.

Handle the lens and all moving parts with care

Do not apply force to the lens, lens cover, monitor, memory card slot or battery chamber. These parts are easily damaged. Applying force to the lens cover could result in camera malfunction or damage to the lens. Should the monitor break, care should be taken to avoid injury caused by broken glass and to prevent the liquid crystal from the display touching the skin or entering the eyes or mouth.

Do not point the lens at strong light sources for extended periods

Avoid pointing the lens at the sun or other strong light sources for extended periods when using or storing the camera. Intense light may cause deterioration of the CCD image sensor, producing a white blur effect in photographs.

Keep away from strong magnetic fields

Do not use or store this device in the vicinity of equipment that generates strong electromagnetic radiation or magnetic fields. Strong static charges or the magnetic fields produced by equipment such as radio transmitters could interfere with the monitor, damage data stored on the memory card, or affect the product's internal circuitry.

Avoid sudden changes in temperature

Sudden changes in temperature, such as when entering or leaving a heated building on a cold day, can cause condensation to form inside the device. To prevent condensation, place the device in a carrying case or a plastic bag before exposing it to sudden changes in temperature.

Turn the product off before removing or disconnecting the power source

Do not remove the battery while the product is on, or while images are being recorded or deleted. Forcibly cutting power in these circumstances could result in loss of data or in damage to product memory or internal circuitry.

The Battery

- Check the battery level when taking the camera out, and charge the battery if necessary. Do not continue charging once the battery is fully charged, as this will result in reduced battery performance. If possible, carry a fully-charged spare battery when taking pictures on important occasions.
- Do not use the battery at ambient temperatures below 0 °C (32 °F) or above 40 °C (104 °F). Failure to observe this precaution could damage the battery or impair its performance.
- Charge indoors at an ambient temperature between 5 and 35 °C (41 to 95 °F). When the battery temperature is between 0 and 10 °C (32 to 50 °F) or 45 to 60 °C (113 to 140 °F), the chargeable capacity may decrease. The battery will not charge if its temperature is below 0 °C (32 °F) or above 60 °C (140 °F).
- If an exhausted battery is used at a low temperature, the camera may not turn on. Be sure that the battery is fully charged and spare batteries are prepared before heading outside to take pictures in cold weather. Keep spare batteries in a warm place and exchange as necessary. Once warmed, a cold battery that could not be used temporarily due to lowered performance may recover some of its charge.
- Should the battery terminals become dirty, the camera may not turn on due to poor contact. Wipe the terminals off with a clean, dry cloth before use.
- If the battery will not be used for some time, insert it in the camera and run it flat before removing it for storage. Attach the included terminal cover to the battery and store it in a cool location with an ambient temperature of 15 to 25 °C (59 to 77 °F). Do not store the battery in hot or extremely cold locations.
- While the battery is in storage, charge it at least once every six months and then use the camera to run it flat again before storing it in a cool location.
- Always remove the battery from the camera or battery charger when it is not being used. Left installed, minute amounts of current flow even when unused, and the battery may become excessively drained and no longer function.
- A marked drop in the time a fully-charged battery retains its charge, when used at room temperature, indicates that the battery needs to be replaced. Purchase a new battery.
- Replace the battery when it no longer holds a charge. Used batteries are a valuable resource. Please recycle used batteries in accordance with local regulations.

Cleaning

Lens	Avoid touching glass parts with your fingers. Remove dust or lint with a blower (typically a small device with a rubber bulb attached to one end that is pumped to produce a stream of air out the other end). To remove fingerprints or other stains that cannot be removed with a blower, wipe the lens with a soft cloth, using a spiral motion that starts at the center of the lens and working toward the edges. If this fails, clean the lens using a cloth lightly dampened with commercial lens cleaner.
Monitor	Remove dust or lint with a blower. To remove fingerprints and other stains, clean the monitor with a soft, dry cloth, being careful not to apply pressure.
Body	Use a blower to remove dust, dirt or sand, then wipe gently with a soft, dry cloth. After using the camera at the beach or seaside, wipe off any sand or salt with a dry cloth lightly dampened with fresh water, then dry thoroughly. Note that foreign matter inside the camera could cause damage not covered by the warranty.

Do not use alcohol, thinner, or other volatile chemicals.

Storage

Turn the camera off when not in use. Check that the power-on lamp is off before putting the camera away. Remove the battery if the camera will not be used for an extended period. Do not store the camera with naphtha or camphor moth balls, or in any of the following locations:

- Next to equipment that produces strong electromagnetic fields, such as televisions or radios
- Exposed to temperatures below -10 °C (14 °F) or above 50 °C (122 °F)
- Poorly ventilated or subject to humidities of over 60 %

To prevent mold or mildew, take the camera out of storage at least once a month. Turn the camera on and release the shutter a few times before putting the camera away again.



Notes on the Monitor

- The monitor may contain a few pixels that are always lit or that do not light. This is a characteristic common to all TFT LCD displays, and does not indicate a malfunction. Images recorded using the product will not be affected.
- Images in the monitor may be difficult to see under bright lighting.
- The monitor is lit by an LED backlight. Should the monitor begin to dim or flicker, contact your Nikon-authorized service representative.













Notes on Smear

White or colored streaks of light may be visible in the monitor with framing of bright subjects. This phenomenon, known as "smear," occurs when extremely bright light strikes the image sensor. This is due to characteristics of the image sensor and does not indicate a malfunction. Smear may also cause partial discoloration in monitor display with shooting.

Smear does not affect recorded images except when shooting with **Continuous** set to **Multi-shot 16** and when recording movies. When shooting in these modes, avoiding bright objects such as the sun, reflections of the sun, and electric lights is recommended.









Error Messages

The following table lists the error messages and other warnings displayed in the monitor, as well as the solutions for dealing with them.





















Display	Problem	Solution	
 (blinks)	Clock not set.	Set clock.	116
	Battery running low.	Prepare to charge or change battery.	12
 Battery exhausted.	Battery exhausted.	Charge or change battery.	12
 Battery temperature high	Battery temperature is high.	Turn off camera, and allow battery to cool down before resuming use. After 5 seconds, this message will disappear, the monitor will turn off, and the power-on lamp and flash lamp will blink rapidly. After the lamps blink for three minutes, the camera will turn off automatically. Pressing the power switch also turns off the camera.	15
 ● (● blinks red)	Camera cannot focus.	<ul style="list-style-type: none"> • Refocus. • Use focus lock. 	24, 25 102
 Please wait for the camera to finish recording.	Camera cannot perform other operations until recording is complete.	Wait until message clears from display automatically when recording is complete.	25
 Memory card is write protected.	Write-protect switch is in "lock" position.	Slide write-protect switch to "write" position.	19
 This card cannot be used.	Error accessing memory card.	<ul style="list-style-type: none"> • Use approved card. • Check that connectors are clean. • Confirm that memory card is correctly inserted. 	131
 This card cannot be read.			18



Error Messages

Display	Problem	Solution	
<p>i Card is not formatted. Format card? No Yes</p>	Memory card has not been formatted for use in this camera.	All data stored on the memory card will be deleted. If there is any data on the card that you want to keep, select No , and backup the data to a computer before formatting the memory card. To format the memory card, select Yes and press the OK button.	19
<p>i Out of memory.</p>	Memory card is full.	<ul style="list-style-type: none"> • Choose smaller image size. • Delete pictures. • Insert new memory card. • Remove memory card and use internal memory. 	94 26, 78, 109 18 18
<p>i Image cannot be saved.</p>	Error occurred while recording picture.	Format internal memory or memory card.	125
	Camera has run out of file numbers.	Replace the memory card, or format the internal memory/memory card.	132
	Picture cannot be used for welcome screen.	The following pictures cannot be used. <ul style="list-style-type: none"> • Pictures taken at an Image mode setting of 16:9. • Pictures created using the small picture or crop functions that are 320 × 240 or smaller in size. 	115
	There is insufficient space to save a copy.	Delete pictures from destination.	109
<p>i Sound file cannot be saved.</p>	The image file cannot have any voice memos attached to it.	<ul style="list-style-type: none"> • Choose an image that was taken using this camera. • Voice memos cannot be attached onto movies. 	67 –
<p>i Album is full. No further pictures can be added.</p>	Over 200 pictures have already been added to favorites folder.	<ul style="list-style-type: none"> • Remove some pictures from favorites folder. 	62
		<ul style="list-style-type: none"> • Add to other favorites folders. 	61

Display	Problem	Solution	
 A blink was detected in the picture just taken.	Someone may have had their eyes closed when the picture was taken.	Check the picture in playback mode.	49
 Image cannot be modified.	Cannot edit selected picture.	Confirm the conditions that are required for editing. These options cannot be used with movies.	68 –
 Cannot record movie.	Time out error while recording movie.	Choose memory card with faster write speed.	18
 Memory contains no images.	No pictures in the internal memory or memory card.	<ul style="list-style-type: none"> • Pictures stored in the internal memory can only be viewed if no memory card is inserted. • To copy files from internal memory to memory card, press the MENU button to display the Copy screen, then copy the files from internal memory to memory card. 	18
	No pictures are contained in the folder selected in auto sort mode.	Select the folder containing the sorted pictures.	56
	No pictures can be played back in auto sort mode.	Playback pictures using playback mode, list by date, or favorite pictures mode.	57
	The picture has not been added to favorites folder.	<ul style="list-style-type: none"> • Add the picture to favorites folder. • Choose the favorites folder that the picture has been added. 	61 62
 File contains no image data.	File not created with this camera.	File cannot be viewed on this camera. View file using the computer or any other devices which was used to create or edit this file.	–
 This file cannot be played back.			
 All images are hidden.	The picture cannot be played back in a slide show.	–	108

Error Messages

Display	Problem	Solution	
 This image cannot be deleted.	Picture is protected.	Disable protection.	109
 Travel destination is in the current time zone.	Destination in same time zone as home.	–	118
Lens error 	Lens error.	Turn camera off and then on again. If error persists, contact retailer or Nikon-authorized service representative.	20
 Communications error	USB cable disconnected during data transfer to printer.	Turn camera off and reconnect cable.	81, 85
System error 	Error has occurred in camera's internal circuitry.	Turn camera off, remove and reinsert battery, and turn camera on. If error persists, contact retailer or Nikon-authorized service representative.	14, 20
  Printer error: check printer status.	Printer error.	Check printer. After solving the problem, select Resume and press the  button to resume printing.*	–
  Printer error: check paper	Specified size of paper is not loaded in printer.	Load the specified paper, select Resume and press the  button to resume printing.*	–
  Printer error: paper jam	Paper has jammed in the printer.	Eject the jammed paper, select Resume and press the  button to resume printing.*	–
  Printer error: out of paper	No paper is loaded in printer.	Load the specified paper, select Resume and press the  button to resume printing.*	–
  Printer error: check ink	Ink error.	Check ink, select Resume and press the  button to resume printing.*	–
  Printer error: out of ink	Running out of ink or ink cartridge is empty.	Replace ink, select Resume and press the  button to resume printing.*	–



Display	Problem	Solution	
 Printer error: file corrupt	An error caused by the image file has occurred.	Select Cancel and press the  button to cancel printing.	-

* See the documentation provided with your printer for further guidance and information.

Troubleshooting

If the camera fails to function as expected, check the list of common problems below before consulting your retailer or Nikon-authorized service representative. Refer to the page numbers in the right-most column for more information.

Display, Settings and Power Supply



Problem	Cause/Solution	
Monitor is blank.	<ul style="list-style-type: none">• Camera is off.• Battery is exhausted.• The camera is in standby mode. Press the power switch, shutter-release button,  button, or .• When flash lamp blinks red, wait until flash has charged.• Camera and computer are connected via USB cable.• Camera and TV are connected via AV cable.	20 20 15, 21 29 81 79
Monitor is hard to read.	<ul style="list-style-type: none">• Adjust monitor brightness.• Monitor is dirty. Clean monitor.	119 135
Camera turns off without warning.	<ul style="list-style-type: none">• Battery is low.• Camera has turned off automatically to save power.• Battery is cold.	20 124 134
Date and time of recording are not correct.	<ul style="list-style-type: none">• Pictures recorded before clock has been set, and "Date not set" indicator blinks during shooting, will have time stamp of "00/00/0000 00:00"; movies will be dated "01/01/2009 00:00". In calendar display or list by date mode, pictures are recognized as having been taken on 01/01/2009. Set the correct time and date from the Date option in the setup menu.• Check camera clock regularly against more accurate timepieces and reset as required.	16, 51 116
No indicators displayed in monitor.	Hide info is selected for Photo info . Select Show info .	119
Date imprint not available.	Camera clock has not been set.	16, 116
Date not appearing on pictures even when Date imprint is enabled.	A shooting mode that does not support date imprint is selected.	120
Camera settings reset.	Backup battery is exhausted; all settings were restored to their default values.	117





Problem	Cause/Solution	
Monitor turns off, and the power-on lamp and flash lamp blink rapidly.	Battery temperature is high. Turn off camera, and allow battery to cool down before resuming use. After the lamps blink for three minutes, the camera will turn off automatically. Pressing the power switch also turns off the camera.	15







Electronically Controlled Cameras

In extremely rare instances, unusual characters may appear in the monitor and the camera may stop functioning. In most cases, this phenomenon is caused by a strong external static charge. Turn the camera off, remove and replace the battery, then turn the camera on again. In the event of continued malfunction, contact your retailer or Nikon-authorized service representative. Note that disconnecting the power source as described above may result in the loss of any data not recorded to internal memory or the memory card at the time the problem occurred. Data already recorded will not be affected.

Shooting

Problem	Cause/Solution	
No picture taken when shutter-release button is pressed.	<ul style="list-style-type: none"> • When camera is in playback mode, press the  button or the shutter-release button. • When menus are displayed, press the MENU button. • Battery is exhausted. • When flash lamp blinks, flash is charging. 	<p>26</p> <p>10</p> <p>20</p> <p>29</p>
Camera cannot focus.	<ul style="list-style-type: none"> • The intended subject is one with which autofocus does not perform well. • Set AF assist in the setup menu to Auto. • Focus error. Turn camera off and then on again. 	<p>25</p> <p>123</p> <p>20</p>
Pictures are blurred.	<ul style="list-style-type: none"> • Use flash. • Use electronic vibration reduction or motion detection. • Use BSS. • Use tripod and self-timer. 	<p>28</p> <p>121,</p> <p>122</p> <p>98</p> <p>30</p>
Streaks of light or partial discoloration appear in the display.	Smear may occur when the lens is aimed at bright subjects. When using the multi-shot 16 shooting and movie modes, we recommend that you avoid shooting when direct sunlight, reflected sunlight, or electric lights are in the display.	98, 136
Bright specks appear in pictures taken with flash.	Flash is reflecting off particles in air. Turn flash off.	29
Flash does not fire.	<ul style="list-style-type: none"> • Flash is off. • Some scene modes that cannot turn on flash are selected. • Smart portrait mode selected, with Blink proof set to On. •  mode is selected. • Another function that is set now is restricting the flash. 	<p>28</p> <p>34</p> <p>49</p> <p>75</p> <p>105</p>
Optical zoom cannot be used.	Optical zoom cannot be used while recording movies.	75

Problem	Cause/Solution	
Digital zoom cannot be used.	<p>Digital zoom is set to Off in the setup menu. Digital zoom is not available in the following situations.</p> <ul style="list-style-type: none"> • When Scene auto selector, Portrait, or Night portrait is selected for scene mode. • When smart portrait mode is selected. • Just before recording a movie (up to 2x can be applied while recording movies). • When Multi-shot 16 is selected for the Continuous setting. 	123 34, 35 47 75 98
Image mode not available.	Another function that is set now is restricting Image mode .	105
No sound when shutter is released.	<ul style="list-style-type: none"> • Off is selected for Sound settings>Shutter sound in setup menu. • Continuous, Multi-shot 16 or BSS is selected for the Continuous setting in shooting menu. •  (Sports scene mode) or  (Museum scene mode) is selected. • Blink proof is set to On for smart portrait mode. •  mode is selected. • The speaker is being blocked. Do not cover it. 	124 98 35, 38 49 75 5, 22
AF-assist illuminator does not light.	<ul style="list-style-type: none"> • Off is selected for AF assist in the setup menu. • AF-assist illuminator turns off automatically in some scene modes. 	123 34-39
Pictures appear smeared.	Lens is dirty. Clean lens.	135
Colors are unnatural.	White balance does not match light source.	96
Randomly spaced bright pixels ("noise") appear in image.	Shutter speed too slow or ISO sensitivity is high as the subject is dark. Noise can be reduced by: <ul style="list-style-type: none"> • Using flash. • Specifying a lower ISO sensitivity setting. • Using a scene mode which has noise reduction ability. 	28 99 34-40

Problem	Cause/Solution	
Pictures are too dark (underexposed).	<ul style="list-style-type: none"> Flash is off. Flash window is blocked. Subject is beyond flash range. Adjust exposure compensation. Raise the ISO sensitivity. Subject is backlit. Select  (Backlight scene mode) or use fill flash. 	28 22 28 32 99 28, 39
Pictures are too bright (overexposed).	Adjust exposure compensation.	32
Unexpected results when flash set to  (auto with red-eye reduction).	If taking pictures with  (auto with red-eye reduction) or fill flash with slow sync and red-eye reduction when scene mode is set to Night portrait , In-Camera Red-Eye Fix may be applied to areas not affected by red-eye. Select any flash mode other than  (auto with red-eye reduction) and select any shooting mode or scene mode other than Night portrait, then try shooting again.	28, 35
Skin softening results are not as expected.	<ul style="list-style-type: none"> Skin softening may not produce the desired results depending on shooting conditions. For pictures with four or more faces, try using Skin softening in the playback menu. 	49 72
Saving images takes time.	It may take more time to save images in the following situations. <ul style="list-style-type: none"> When the noise reduction function is in operation. When flash is set to  (auto with red-eye reduction). When using skin softening while shooting. 	34 29 34, 35, 48

Playback

Problem	Cause/Solution	
File cannot be played back.	File or folder was overwritten or renamed by computer or other make of camera.	–
Cannot zoom in on picture.	Playback zoom cannot be used with movies, small pictures, or pictures that have been cropped to a size of 320 × 240 or smaller.	–
Cannot record or play back voice memos.	<ul style="list-style-type: none"> • Voice memos cannot be appended to movies. • Voice memos cannot be attached to images taken with other cameras. Voice memos that are attached to the image using other cameras cannot be played back on this camera. 	78 67
Cannot use quick retouch, D-Lighting, crop, skin softening, or small picture options.	<ul style="list-style-type: none"> • These options cannot be used with movies. • These options cannot be used with pictures taken when 16:9 is applied in the Image mode setting. • Select pictures that support quick retouch, D-Lighting, crop, skin softening, or small picture. • Camera is unable to edit pictures taken with other cameras. • Other cameras may be unable to play back pictures recorded with this camera. 	78 94 68 68 68
Pictures not displayed on television.	<ul style="list-style-type: none"> • Choose correct Video mode. • Memory card contains no pictures. Replace the memory card. Remove the memory card to play back pictures from the internal memory. 	126 18
Control settings for favorites folder restore to default settings, or pictures added to favorites are not displayed during favorite pictures playback.	Data in the memory card may not be played back correctly if overwritten on a computer.	–

Problem	Cause/Solution	
The recorded pictures are not displayed in auto sort mode.	<ul style="list-style-type: none"> • The picture you want to display is sorted in a folder other than that you are browsing. • Pictures recorded by another camera, and pictures copied using Copy on another camera cannot be displayed in the auto sort mode. • Pictures in the internal memory or memory card may not be played back correctly if overwritten on a computer. • Up to 999 pictures and movie files can be added to each folder. If the desired folder already contains 999 pictures, new pictures or movies cannot be added. 	<p>56</p> <p>57</p> <p>–</p> <p>–</p>
Nikon Transfer does not start when camera is connected.	<ul style="list-style-type: none"> • Camera is off. • Battery is exhausted. • USB cable is not correctly connected. • Camera is not recognized by the computer. • Computer is not set to start Nikon Transfer automatically. <p>For more information on Nikon Transfer, refer to help information contained in Nikon Transfer.</p> <ul style="list-style-type: none"> • Check the compatible operating systems. 	<p>20</p> <p>20</p> <p>81</p> <p>–</p> <p>83</p> <p>80</p>
Pictures to be printed are not displayed.	<ul style="list-style-type: none"> • Memory card contains no pictures. Replace memory card. • Remove memory card to print pictures from internal memory. 	<p>18</p>
Cannot select paper size with camera.	<p>Paper size cannot be selected from the camera if the printer does not support the paper sizes used by the camera, or the printer automatically selects the paper size. Use the printer to select paper size.</p>	<p>86, 87</p>

Specifications

Nikon COOLPIX S570 Digital Camera

Type	Compact digital camera
Effective pixels	12.0 million
Image sensor	¹ /2.3-in. CCD; approx. 12.39 million total pixels
Lens	5x optical zoom, NIKKOR lens
Focal length	5.0-25.0mm (equivalent with 35mm [135] format picture angle: 28-140mm)
f/-number	f/2.7-6.6
Construction	7 elements in 6 groups
Digital zoom	Up to 4x (equivalent with 35mm [135] format picture angle: approx. 560mm)
Vibration reduction	Electronic VR
Autofocus (AF)	Contrast-detect AF
Focus range (from lens)	<ul style="list-style-type: none">• [W]: Approx. 45 cm (1 ft. 6 in.) to ∞, [T]: Approx. 70 cm (2 ft. 4 in.) to ∞• Macro mode: Approx. 3 cm (1.2 in.) to ∞ (when the zoom is zoomed out)
Focus-area selection	Auto (9-area automatic selection), center, manual with 99 focus areas, face priority
Monitor	6.7 cm/2.7-in., approx. 230k-dot, TFT LCD and 5-level brightness adjustment
Frame coverage (shooting mode)	Approx. 97% horizontal and 97% vertical
Frame coverage (playback mode)	Approx. 100% horizontal and 100% vertical
Storage	
Media	<ul style="list-style-type: none">• Internal memory (approx. 47 MB)• SD (Secure Digital) memory cards
File system	DCF, Exif 2.2, and DPOF compliant
File formats	Still pictures: JPEG Movies: AVI (Motion-JPEG compliant) Sound files: WAV
Image size (pixels)	<ul style="list-style-type: none">• 4,000 × 3,000 High (4000★)/Normal (4000)• 3,264 × 2,448 Normal (3264)• 2,592 × 1,944 Normal (2592)• 2,048 × 1,536 Normal (2048)• 1,024 × 768 PC screen (1024)• 640 × 480 TV screen (640)• 3,968 × 2,232 16:9 (3968)
ISO sensitivity (Standard output sensitivity)	ISO 80, 100, 200, 400, 800, 1600, 3200, Auto (auto gain from ISO 80 to 1600), Fixed range auto (ISO 80 to 400, 80 to 800)

Specifications

Exposure	
Metering	256-segment matrix, center-weighted (digital zoom less than 2x), spot (digital zoom 2x or more)
Exposure control	Programmed auto exposure with motion detection and exposure compensation (-2.0 to +2.0 EV in steps of 1/3 EV)
Range (ISO 100)	[W]: -1.1 to +15.7 EV [T]: 1.5 to 18.3 EV
Shutter	Mechanical and charge-coupled electronic shutter
Speed	1/1500-1 s (when ISO sensitivity is set to Auto or locked) 4 s (when scene mode is set to Fireworks show)
Aperture	Electronically-controlled ND filter (-2 AV) selection
Range	2 steps (f/2.7 and f/5.4 [W])
Self-timer	Can be selected from 10 and 2 second duration
Built-in flash	
Range (approx.) (ISO sensitivity: Auto)	[W]: 0.5 to 5.5 m (1 ft. 8 in. to 18 ft.) [T]: 0.5 to 2.2 m (1 ft. 8 in. to 7 ft. 3 in.)
Flash control	TTL auto flash with monitor preflashes
Interface	Hi-Speed USB
Data Transfer Protocol	MTP, PTP
Video output	Can be selected from NTSC and PAL
I/O terminal	Audio/video output; digital I/O (USB)
Supported languages	Arabic, Chinese (Simplified and Traditional), Czech, Danish, Dutch, English, Finnish, French, Greek, German, Hungarian, Indonesian, Italian, Japanese, Korean, Polish, Portuguese, Norwegian, Russian, Spanish, Swedish, Thai, Turkish
Power sources	One Rechargeable Li-ion Battery EN-EL10 (supplied) AC Adapter EH-62D (available separately)
Battery life*	Approx. 220 shots (EN-EL10)
Dimensions (W × H × D)	Approx. 92 × 56.5 × 21.5 mm (3.6 × 2.2 × 0.8 in.) (excluding projections)
Weight	Approx. 120 g (4.2 oz.) (without battery and SD memory card)
Operating environment	
Temperature	0 to 40 °C (32 to 104 °F)
Humidity	Less than 85% (no condensation)

- Unless otherwise stated, all figures are for a camera with a fully-charged Rechargeable Li-ion Battery EN-EL10 operated at an ambient temperature of 25 °C (77 °F).
- * Based on Camera and Imaging Products Association (CIPA) standards for measuring the life of camera batteries. Measured at 23 °C (73 °F); zoom adjusted with each shot, flash fired with every other shot, image mode set to  **Normal (4000)**. Battery life may vary depending on shooting interval and length of time menus and images are displayed.

Rechargeable Li-ion Battery EN-EL10

Type	Rechargeable lithium-ion battery
Rated capacity	DC 3.7 V, 740 mAh
Operating temperature	0 to 40 °C (32 to 104 °F)
Dimensions (W × H × D)	Approx. 31.5 × 39.5 × 6 mm (1.2 × 1.6 × 0.2 in.) (excluding projections)
Weight	Approx. 15 g (0.5 oz) (excluding battery case)

Battery Charger MH-63

Rated input	AC 100-240 V, 50/60 Hz, 0.07-0.045 A
Rated capacity	7-10.8 VA
Rated output	DC 4.2 V, 0.55 A
Battery	Rechargeable Li-ion Battery EN-EL10
Charging time	Approx. 100 minutes when battery is fully discharged
Operating temperature	0 to 40 °C (32 to 104 °F)
Dimensions (W × H × D)	Approx. 54 × 20 × 85 mm (2.1 × 0.8 × 3.3 in.) (excluding power cable)
Length of power cable	Approx. 1.8 m (6 ft.)
Weight	Approx. 55 g (1.9 oz) (excluding power cable)

Specifications

Nikon will not be held liable for any errors this manual may contain. The appearance of this product and its specifications are subject to change without notice.

Supported Standards

- **DCF:** Design Rule for Camera File System is a standard widely used in the digital camera industry to ensure compatibility among different makes of camera.
- **DPOF:** Digital Print Order Format is an industry-wide standard that allows pictures to be printed from print orders stored on the memory card.
- **Exif version 2.2:** This camera supports Exif (Exchangeable Image File Format for Digital Still Cameras) version 2.2, a standard that allows information stored with photographs to be used for optimal color reproduction when images are output from Exif-compliant printers.
- **PictBridge:** A standard developed cooperatively by the digital camera and printer industries, allowing photographs to be output directly to a printer without connecting the camera to a computer.

Index

Symbols

AE/AF-L 46

(shooting mode) button 5, 8

T (Tele) 4, 23

W (Wide) 4, 23

Apply selection button 5, 9

Auto mode 20

Auto sort mode 56

Delete button 5, 26, 27, 67, 78

Exposure compensation 32

Favorite pictures mode 59

Flash mode 28

Help 4, 11

List by date mode 53

Macro mode 31

MENU Menu button 5

Movie mode 75

Playback mode 5, 8, 26

Playback zoom 4, 52

Scene mode 33

Self timer 30

Setup menu 112

Smart portrait mode 47

Thumbnail playback 4, 50

.AVI 132

JPG 132

.WAV 132

A

AC adapter 131

AF area 24

AF area mode 101

AF assist 123

Audio-in/Video-in jack 79

Auto flash 28

Auto focus 31

Auto mode 20

Auto off 124

Auto sort menu 58

Auto sort mode 56

Autofocus 77

Autofocus mode 77

AV cable 79

B

Back light 39

Battery 12, 14, 117

Battery chamber 5

Battery charger 12, 131

Battery latch 5

Battery level 20

Battery-chamber/memory card slot cover 5, 14, 18

Beach/snow 36

Best Shot Selector 98

Black-and-white 100

Brightness 119

BSS 98

Built-in flash 4, 28

Built-in microphone 4, 66

Button sound 124

C

Cable connector 4, 79, 80, 84

Calendar display 51

Close-up 38

Cloudy 96

Color options 100

Compression ratio 94

Computer 80, 80–83

 copying pictures to 80–83

Continuous 98

Copy 39

Copying pictures 110

Crop 74

Cyanotype 100

D

Date 16, 116

Date imprint 120

Daylight 96

Delete 109

Digital zoom 23, 123



Direct print 84

D-Lighting 71
 DPOF print 89
 DSCN 132
 Dusk/dawn  37

E

Electronic VR (movies) 77
 Electronic VR (still pictures) 121
 EN-EL10 12, 14
 Exposure compensation 32
 Extension 132
 Eyelet for camera strap 4

F

Face priority 101
 Favorite pictures menu 64
 Favorite pictures mode 63
 File names 132
 Fill flash 28
 Fireworks show  39
 Firmware version 130
 Fixed range auto 99
 Flash 28, 29
 Flash lamp 5, 29
 Flash off 28
 Fluorescent 96
 Focus 24, 77, 101
 Focus lock 102
 Folder name 132
 Food  43
 Format 19, 125
 Format memory card 19, 125
 Formatting internal memory 125
 FSCN 132
 Full-time AF 77

H

Halfway 11
 Help 11

I

Identifier 132
 Image mode 21, 33, 94, 95
 Image review 119

Image size 94
 Incandescent 96
 Internal memory 18
 ISO sensitivity 99

L

Landscape  34
 Language 126
 Lens 4, 149
 Li-ion rechargeable battery 12, 14
 List by date menu 55
 List by date mode 53

M

Macro mode 31
 Memory capacity 20
 Memory card 18, 131
 Memory card slot 5, 18
 Menus 114
 Monitor 5, 6, 135
 Monitor settings 119
 Motion detection 122
 Movie menu 76
 Movie mode 75
 Movie options
 TV movie 76
 Movie playback 78
 Movie settings 76
 Multi selector 5, 9
 Multi-shot 16 98
 Museum  38



N





Night landscape  37
 Night portrait  35
 Nikon Transfer 80, 81
 Number of exposures remaining 20, 95

O

Optional accessories 131

P

Panorama assist  40, 45
 Paper size 86, 87
 Party/indoor  36

- Photo info 119
- PictBridge 84
- Pin cover 5
- Playback 26, 27, 50, 52
- Playback menu 106
- Playback-mode selection menu 8
- Portrait  34
- Power 16, 20
- Power switch 4, 20
- Power-on lamp 4, 20
- Preset manual 97
- Print 86, 87, 90
- Print set 90, 92
- Print Set (Date) 91
- Printer 84
- Protect 109
- R**
- Rechargeable battery 131
- Rechargeable Li-ion battery 12, 14
- Recording movies 75
- Red-eye reduction 28, 29
- Reset all 128
- Rotate image 110
- RSCN 132
- S**
- Scene auto selector  34, 41
- Scene mode 33, 34
- Self-timer 30
- Self-timer lamp 4, 30
- Sepia 100
- Setup menu 112
- Shooting 20, 22, 24
- Shooting menu 93
- Shooting-mode selection menu 8
- Shutter sound 124
- Shutter-release button 4, 24
- Single 98
- Single AF 77
- Skin softening 48, 72
- Slide show 108
- Slow sync 28
- Small picture 73
- Smart portrait menu 48
- Smart portrait mode 47
- Smile timer 49
- Software Suite 80
- Sound settings 124
- Speaker 5
- Sports  35
- SSCN 132
- Standard color 100
- Strap 11
- Sunset  36
- T**
- Thumbnail playback 50
- Time zone 116, 118
- Tripod 5
- TV 79
- TV movie 76
- U**
- USB cable 80, 81, 85
- V**
- Video mode 79, 126
- ViewNX 80, 82
- Vivid color 100
- Voice memo 66
- Volume 78
- W**
- Welcome screen 115
- White balance 96
- Z**
- Zoom control 4, 78



A series of horizontal dashed lines spanning the width of the page, intended for handwriting practice. There are 15 lines in total, starting from the top right and extending to the left edge of the page.



A series of horizontal dashed lines for handwriting practice, spanning the width of the page.



A series of horizontal dashed lines for handwriting practice, consisting of 15 lines spaced evenly down the page.

Nikon

No reproduction in any form of this manual, in whole or in part (except for brief quotation in critical articles or reviews), may be made without written authorization from NIKON CORPORATION.



NIKON CORPORATION

Printed in Europe

© 2009 Nikon Corporation

CT0D02(11)
6MM72611-02