

Nikon

DIGITAL CAMERA

COOLPIX S205

User's Manual



En

Trademark Information

- Microsoft, Windows and Windows Vista are either registered trademarks or trademarks of Microsoft Corporation in the United States and/or other countries.
- Macintosh, Mac OS, and QuickTime are trademarks of Apple Inc.
- Adobe and Acrobat are registered trademarks of Adobe Systems Inc.
- SD and SDHC Logos are trademarks of SD-3C, LLC.
- PictBridge is a trademark.
- All other trade names mentioned in this manual or the other documentation provided with your Nikon product are trademarks or registered trademarks of their respective holders.

Introduction

First Steps

Basic Photography and Playback:  (Auto) Mode

More on Shooting

More on Playback

Editing Pictures

Movie Recording and Playback

Connecting to Televisions, Computers and Printers

Basic Camera Setup

Caring for the Camera

Technical Notes and Index

For Your Safety

To prevent damage to your Nikon product or injury to yourself or to others, read the following safety precautions in their entirety before using this equipment. Keep these safety instructions where all those who use the product will read them.



This icon marks warnings, information that should be read before using this Nikon product, to prevent possible injury.

WARNINGS

Turn off in the event of malfunction

Should you notice smoke or an unusual smell coming from the camera or Charging AC adapter, unplug the Charging AC adapter and remove the battery immediately, taking care to avoid burns. Continued operation could result in injury. After removing or disconnecting the power source, take the equipment to a Nikon-authorized service representative for inspection.

Do not disassemble

Touching the internal parts of the camera or Charging AC adapter could result in injury. Repairs should be performed only by qualified technicians. Should the camera or Charging AC adapter break open as the result of a fall or other accident, take the product to a Nikon-authorized service representative for inspection, after unplugging the product and/or removing the battery.

Do not use the camera or Charging AC adapter in the presence of flammable gas

Do not use electronic equipment in the presence of flammable gas, as this could result in explosion or fire.

Handle the camera strap with care

Never place the strap around the neck of an infant or child.

Keep out of reach of children

Particular care should be taken to prevent infants from putting the battery or other small parts into their mouths.

Observe caution when handling the battery

The battery may leak or explode if improperly handled. Observe the following precautions when handling the battery for use in this product:

- Before replacing the battery, turn the product off. If you are using the Charging AC Adapter/AC adapter, be sure it is unplugged.
- Use only a Rechargeable Li-ion Battery EN-EL10 (supplied). Charge the battery inserted into the camera by connecting the Charging AC Adapter EH-68P/EH-68P (AR) (supplied).
- When inserting the battery, do not attempt to insert it upside down or backwards.
- Do not short or disassemble the battery or attempt to remove or break the battery insulation or casing.
- Do not expose the battery to flame or to excessive heat.
- Do not immerse in or expose to water.
- Return the battery to the battery case for transportation. Do not transport or store with metal objects such as necklaces or hairpins.
- The battery is prone to leakage when fully discharged. To avoid damage to the product, be sure to remove the battery when no charge remains.
- Discontinue use immediately should you notice any change in the battery, such as discoloration or deformation.

Observe the following precautions when handling the Charging AC Adapter

- If liquid from the damaged battery comes in contact with clothing or skin, rinse immediately with plenty of water.
- Keep dry. Failure to observe this precaution could result in fire or electric shock.
- Dust on or near the metal parts of the plug should be removed with a dry cloth. Continued use could result in fire.
- Do not handle the plug or go near the Charging AC Adapter during lightning storms. Failure to observe this precaution could result in electric shock.
- Do not damage, modify, forcibly tug or bend the USB cable, place it under heavy objects, or expose it to heat or flames. Should the insulation be damaged and the wires become exposed, take it to a Nikon-authorized service representative for inspection. Failure to observe these precautions could result in fire or electric shock.
- Do not handle the plug or Charging AC Adapter with wet hands. Failure to observe this precaution could result in electric shock.
- Do not use with travel converters or adapters designed to convert from one voltage to another or with DC-to-AC inverters. Failure to observe this precaution could damage the product or cause overheating or fire.

 **Use appropriate cables**

When connecting cables to the input and output jacks, use only the cables provided or sold by Nikon for the purpose, to maintain compliance with product regulations.

 **Handle moving parts with care**

Be careful that your fingers or other objects are not pinched by the lens cover or other moving parts.

 **CD-ROMs**

The CD-ROMs supplied with this device should not be played back on audio CD equipment. Playing CD-ROMs on an audio CD player could cause hearing loss or damage the equipment.

 **Observe caution when using the flash**

Using the flash close to your subject's eyes could cause temporary visual impairment. Particular care should be observed if photographing infants, when the flash should be no less than 1 m (3 ft. 4 in.) from the subject.

 **Do not operate the flash with the flash window touching a person or object**

Failure to observe this precaution could result in burns or fire.

 **Avoid contact with liquid crystal**

Should the monitor break, care should be taken to avoid injury caused by broken glass and to prevent liquid crystal from the monitor touching the skin or entering the eyes or mouth.

 **Turn the power off when using inside an airplane or the hospital**

Turn the power off while inside the airplane during take off or landing. Follow the instructions of the hospital when using while in a hospital. The electromagnetic waves given out by this camera may disrupt the electronic systems of the airplane or the instruments of the hospital.

Notices

Notices for Customers in the U.S.A.

IMPORTANT SAFETY INSTRUCTIONS— SAVE THESE INSTRUCTIONS.

DANGER – TO REDUCE THE RISK OF FIRE OR ELECTRIC SHOCK, CAREFULLY FOLLOW THESE INSTRUCTIONS

For connection to a supply not in the U.S.A., use an attachment plug adapter of the proper configuration for the power outlet if needed.

The power supply unit intended correctly orientated in a vertical or floor mount position.

Federal Communications Commission (FCC) Radio Frequency Interference Statement

This equipment has been tested and found to comply with the limits for a Class B digital device, pursuant to Part 15 of the FCC rules. These limits are designed to provide reasonable protection against harmful interference in a residential installation. This equipment generates, uses, and can radiate radio frequency energy and, if not installed and used in accordance with the instructions, may cause harmful interference to radio communications. However, there is no guarantee that interference will not occur in a particular installation. If this equipment does cause harmful interference to radio or television reception, which can be determined by turning the equipment off and on, the user is encouraged to try to correct the interference by one or more of the following measures:

- Reorient or relocate the receiving antenna.
- Increase the separation between the equipment and receiver.
- Connect the equipment into an outlet on a circuit different from that to which the receiver is connected.
- Consult the dealer or an experienced radio/television technician for help.



Nikon

COOLPIX S205

CAUTIONS

Modifications

The FCC requires the user to be notified that any changes or modifications made to this device that are not expressly approved by Nikon Corporation may void the user's authority to operate the equipment.

Interface Cables

Use the interface cables sold or provided by Nikon for your equipment. Using other interface cables may exceed the limits of Class B Part 15 of the FCC rules.

Notice for customers in the State of California

WARNING

Handling the cord on this product will expose you to lead, a chemical known to the State of California to cause birth defects or other reproductive harm.

Wash hands after handling.

Nikon Inc.,
1300 Walt Whitman Road
Melville, New York 11747-3064
USA
Tel: 631-547-4200

Notice for customers in Canada

CAUTION

This Class B digital apparatus complies with Canadian ICES-003.

ATTENTION

Cet appareil numérique de la classe B est conforme à la norme NMB-003 du Canada.

Notices for customers in Europe

CAUTION

RISK OF EXPLOSION IF BATTERY IS REPLACED BY AN INCORRECT TYPE.

DISPOSE OF USED BATTERIES ACCORDING TO THE INSTRUCTIONS.

This symbol indicates that this product is to be collected separately.



The following apply only to users in European countries:

- This product is designated for separate collection at an appropriate collection point. Do not dispose of as household waste.
- For more information, contact the retailer or the local authorities in charge of waste management.





This symbol on the battery indicates that the battery is to be collected separately.



The following apply only to users in European countries:

- All batteries, whether marked with this symbol or not, are designated for separate collection at an appropriate collection point. Do not dispose of as household waste.
- For more information, contact the retailer or the local authorities in charge of waste management.

Table of Contents

For Your Safety	ii
WARNINGS.....	ii
Notices	v
Introduction	1
About This Manual	1
Information and Precautions.....	2
Parts of the Camera.....	4
The Camera Body	4
The Monitor.....	6
Basic Operations.....	8
The  (Shooting Mode) Button.....	8
The  (Playback) Button.....	8
The Multi Selector.....	9
The MENU Button.....	10
Switching Between Tabs.....	10
Help Displays.....	11
The Shutter-release Button.....	11
Attaching the Camera Strap	11
First Steps	12
Inserting the Battery	12
Removing the Battery	13
Charging the Battery	14
Turning On and Off the Camera.....	17
Setting Display Language, Date and Time	18
Inserting Memory Cards.....	20
Removing Memory Cards.....	20
Basic Photography and Playback:  (Auto) Mode.....	22
Step 1 Turn the Camera On and Select  (Auto) Mode	22
Indicators Displayed in  (Auto) Mode	23
Step 2 Frame a Picture	24
Using the Zoom.....	25
Step 3 Focus and Shoot	26
Step 4 Playing Back and Deleting Pictures	28
Playing Back Pictures (Playback Mode).....	28
Deleting Pictures.....	28
Using the Flash.....	30
Setting the Flash Mode	30
Taking Pictures with the Self-timer	32
Macro Mode	33
Adjusting Brightness (Exposure Compensation)	34

More on Shooting	35
Selecting a Shooting Mode	35
Shooting Options: The Shooting Menu (📷 (Auto) Mode)	36
🔍 Image Mode (Image Quality/Image Size)	37
WB White Balance (Adjusting Hue)	39
📄 Continuous	41
ISO ISO Sensitivity	42
🔗 Color Options	43
[+] AF Area Mode	44
▶️ Autofocus Mode	48
Camera Settings that Cannot Be Applied Simultaneously	49
Shooting Suited to Scenes (Scene Mode)	50
Selecting a Scene Mode	50
Shooting in the Scene Mode Selected by the Camera (Scene Auto Selector)	51
Selecting a Scene Mode to Take Pictures (Features)	53
Shooting for a Panorama	60
Shooting Smiling Faces (Smart Portrait Mode)	62
Smart Portrait Menu	64
Focusing on a Moving Subject (Subject Tracking Mode)	65
Shooting in Subject Tracking Menu	67
More on Playback	68
Operations in Full-frame Playback Mode	68
Viewing Multiple Pictures: Thumbnail Playback	69
Calendar Display	71
Taking a Closer Look: Playback Zoom	72
Selecting a Playback Mode	73
Sorting Favorite Pictures (Favorite Pictures Mode)	74
Adding Pictures to Albums	74
Viewing Pictures in an Album	75
Removing Pictures from Albums	76
Using Favorite Pictures Mode	77
Favorite Pictures Menu	77
Changing Icons Assigned to Albums	78
Finding Pictures in Auto Sort Mode	80
Displaying Pictures in Auto Sort Mode	80
Using Auto Sort Mode	82
Auto Sort Menu	82
Viewing Pictures by Date (List by Date)	83
Selecting a Date in List by Date Mode	83
Using List by Date Mode	84
List by Date Menu	85
Playback Option: Playback Menu	86



































 Print Set (Creating a DPOF Print Order)	87
 Slide Show	91
 Delete (Deleting Multiple Pictures)	92
 Protect	94
 Rotate Image	94
 Voice Memos	95
 Copy (Copy Between Internal Memory and Memory Card)	97
<hr/>	
Editing Pictures	98
Editing Functions	98
Picture Editing	100
 Quick Retouch: Enhancing Contrast and Saturation	100
 D-Lighting: Enhancing Brightness and Contrast	101
 Skin Softening: Softening Skin Tones	102
 Small Picture: Resizing Pictures	104
 Crop: Creating a Cropped Copy	105
<hr/>	
Movie Recording and Playback	106
Recording Movies	106
The Movie Menu	108
 Movie Options	108
 Autofocus Mode	109
 Electronic VR	109
Movie Playback	110
Deleting Movie	110
<hr/>	
Connecting to Televisions, Computers and Printers	111
Connecting to a TV	111
Connecting to a Computer	112
Before Connecting the Camera	112
Transferring Pictures from the Camera to a Computer	113
Charging While Connecting to a Computer	117
Connecting to a Printer	119
Connecting the Camera to a Printer	120
Printing Pictures One at a Time	121
Printing Multiple Pictures	122
<hr/>	
Basic Camera Setup	125
Setup Menu	125
 Menu	127
 Welcome Screen	128
 Date	129
 Monitor Settings	132
 Date Imprint (Imprinting Date and Time)	133

Table of Contents

 Electronic VR.....	134
 Motion Detection.....	135
 AF Assist.....	136
 Digital Zoom.....	136
 Sound Settings.....	137
 Auto Off.....	137
 Format Memory/  Format Card.....	138
 Language.....	139
 VIDEO Video Mode.....	139
 Charge by Computer.....	140
 Blink Warning.....	141
 Reset All.....	143
 Ver Firmware Version.....	145
<hr/>	
Caring for the Camera.....	146
Maximizing Camera Life and Performance.....	146
Cleaning.....	148
Storage.....	148
<hr/>	
Technical Notes and Index.....	149
Optional Accessories.....	149
Approved Memory Cards.....	150
Image/Sound File and Folder Names.....	151
Error Messages.....	152
Troubleshooting.....	157
Specifications.....	163
Supported Standards.....	166
Index.....	167

About This Manual

Thank you for your purchase of a Nikon COOLPIX S205 digital camera. This manual was written to help you enjoy taking pictures with your Nikon digital camera. Read this manual thoroughly before use, and keep it where all those who use the product will read it.

Symbols and Conventions

To make it easier to find the information you need, the following symbols and conventions are used:



This icon marks cautions, information that should be read before use, to prevent damage to the camera.



This icon marks tips, additional information that may be helpful when using the camera.



This icon marks notes, information that should be read before using the camera.



This icon indicates that more information is available elsewhere in this manual.

Notations

- Secure Digital (SD) memory card and SDHC memory card are referred to as “memory card.”
- The setting at the time of purchase is referred to as the “default setting.”
- The names of menu items displayed in the camera monitor, and the names of buttons or messages displayed on a computer monitor appear in bold.

Screen Samples

In this manual, images are sometimes omitted from monitor display samples so that monitor indicators can be more clearly shown.

Illustrations and Screen Display

Illustrations and text displays shown in this manual may differ from actual display.

Internal Memory and Memory Cards

Pictures taken with this camera can be stored in the camera's internal memory or on removable memory cards. If a memory card is inserted, all new pictures will be stored on the memory card and delete, playback and format operations will apply only to the pictures on the memory card. The memory card must be removed before the internal memory can be formatted or accessed for picture storage, deletion, or viewing.

Information and Precautions

Life-Long Learning

As part of Nikon's "Life-Long Learning" commitment to ongoing product support and education, continually updated information is available online at the following sites:

- For users in the U.S.A.: <http://www.nikonusa.com/>
- For users in Europe and Africa: <http://www.europe-nikon.com/support/>
- For users in Asia, Oceania, and the Middle East: <http://www.nikon-asia.com/>

Visit these sites to keep up-to-date with the latest product information, tips, answers to frequently asked questions (FAQs), and general advice on digital imaging and photography. Additional information may be available from the Nikon representative in your area. Visit the site below for contact information.

<http://imaging.nikon.com/>

Use Only Nikon Brand Electronic Accessories

Nikon COOLPIX cameras are designed to the highest standards and include complex electronic circuitry. Only Nikon brand electronic accessories (including battery chargers, batteries, Charging AC Adapter, and AC adapters) certified by Nikon specifically for use with this Nikon digital camera are engineered and proven to operate within the operational and safety requirements of this electronic circuitry.

THE USE OF NON-NIKON ELECTRONIC ACCESSORIES COULD DAMAGE THE CAMERA AND MAY VOID YOUR NIKON WARRANTY.

The use of third-party rechargeable Li-ion batteries not bearing the Nikon holographic seal could interfere with normal operation of the camera or result in the batteries overheating, igniting, rupturing, or leaking.

For more information about Nikon brand accessories, contact a local authorized Nikon dealer.



Holographic seal:

Identifies this device as an authentic Nikon product.

Before Taking Important Pictures

Before taking pictures on important occasions (such as at weddings or before taking the camera on a trip), take a test shot to ensure that the camera is functioning normally. Nikon will not be held liable for damages or lost profits that may result from product malfunction.

About the Manuals

- No part of the manuals included with this product may be reproduced, transmitted, transcribed, stored in a retrieval system, or translated into any language in any form, by any means, without Nikon's prior written permission.
- Nikon reserves the right to change the specifications of the hardware and software described in these manuals at any time and without prior notice.
- Nikon will not be held liable for any damages resulting from the use of this product.
- While every effort was made to ensure that the information in these manuals is accurate and complete, we would appreciate it were you to bring any errors or omissions to the attention of the Nikon representative in your area (address provided separately).

Notice Concerning Prohibition of Copying or Reproduction

Note that simply being in possession of material that was digitally copied or reproduced by means of a scanner, digital camera or other device may be punishable by law.

- **Items prohibited by law from being copied or reproduced**

Do not copy or reproduce paper money, coins, securities, government bonds or local government bonds, even if such copies or reproductions are stamped "Sample." The copying or reproduction of paper money, coins, or securities which are circulated in a foreign country is prohibited. Unless the prior permission of the government was obtained, the copying or reproduction of unused postage stamps or post cards issued by the government is prohibited. The copying or reproduction of stamps issued by the government and of certified documents stipulated by law is prohibited.

- **Cautions on certain copies and reproductions**

The government has issued cautions on copies or reproductions of securities issued by private companies (shares, bills, checks, gift certificates, etc.), commuter passes or coupon tickets, except when a minimum of necessary copies are to be provided for business use by a company. Also, do not copy or reproduce passports issued by the government, licenses issued by public agencies and private groups, ID cards and tickets, such as passes and meal coupons.

- **Comply with copyright notices**

The copying or reproduction of copyrighted creative works such as books, music, paintings, woodcut prints, maps, drawings, movies and photographs is governed by national and international copyright laws. Do not use this product for the purpose of making illegal copies or to infringe copyright laws.

Disposing of Data Storage Devices

Please note that deleting images or formatting data storage devices such as memory cards or built-in camera memory does not completely erase the original image data. Deleted files can sometimes be recovered from discarded storage devices using commercially available software, potentially resulting in the malicious use of personal image data. Ensuring the privacy of such data is the user's responsibility.

Before discarding a data storage device or transferring ownership to another person, erase all data using commercial deletion software, or format the device and then completely refill it with images containing no private information (for example, pictures of empty sky). Be sure to also replace any pictures selected for the **Select an image** option in the **Welcome screen** setting (📖 128). Care should be taken to avoid injury or damage to property when physically destroying data storage devices.

Parts of the Camera

The Camera Body

Introduction

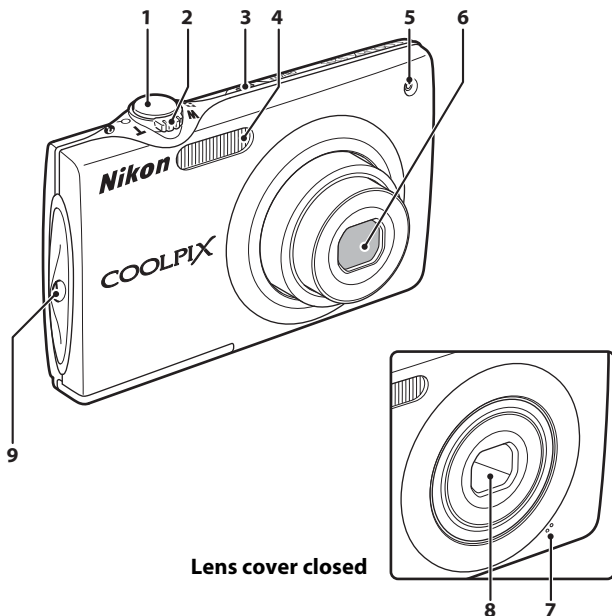

Lens cover closed

1	Shutter-release button.....	26	4	Built-in flash.....	30
	Zoom control.....	25	5	Self-timer lamp	32
	W : wide.....	25	6	AF-assist illuminator.....	136
2	T : tele.....	25	7	Lens.....	148, 163
	thumbnail playback.....	69	8	Built-in microphone.....	95, 106
	playback zoom.....	72	9	Lens cover	146
	help.....	11		Eyelet for camera strap.....	11
3	Power switch/power-on lamp.....	17, 22, 137			

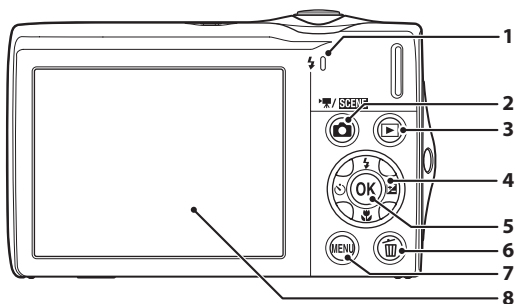

Opening the connector cover

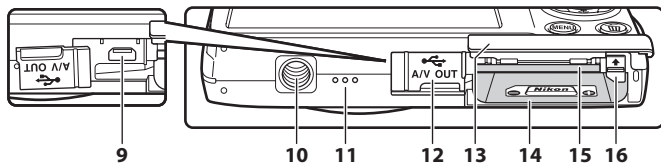

1	Charge lamp.....	15, 117
	Flash lamp.....	31
2	📷 (shooting mode) button.....	8, 35
3	▶ (playback) button	8, 28, 73
4	Multi selector	9
5	⊙ (apply selection) button	9
6	🗑 (delete) button	28, 29, 96, 110
7	MENU button.....	10, 36, 86, 126
8	Monitor	6, 23
9	USB/audio/video output connector	111, 113, 120

10	Tripod socket	
11	Speaker	96, 110
12	Connector cover	111, 113, 120, 151
13	Battery-chamber/ memory card slot cover	12, 20
14	Battery chamber.....	12
15	Memory card slot.....	20
16	Battery latch.....	12, 13

The Monitor

The following indicators may appear in the monitor during shooting and playback (actual display varies with current camera settings).

The indicators that appear in the monitor during shooting and playback disappear after a few seconds (📖 132).

Shooting

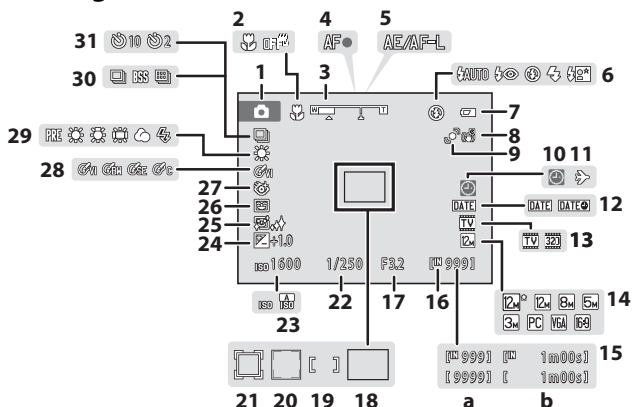

1	Shooting mode*22, 50, 62, 65, 106	16	Internal memory indicator.....23
2	Macro mode.....33	17	Aperture.....26
3	Zoom indicator.....25, 33	18	Focus area (auto).....26, 44
4	Focus indicator.....26	19	Focus area (for manual or center).....44
5	AE/AF-L indicator.....61	20	Focus area (face priority).....26, 44, 62
6	Flash mode.....30	21	Focus area (subject tracking mode).....65
7	Battery level indicator.....22	22	Shutter speed.....26
8	Electronic VR icon.....134	23	ISO sensitivity.....31, 42
9	Motion detection icon.....23, 135	24	Exposure compensation value.....34
10	"Date not set" indicator.....152	25	Skin softening.....62, 64
11	Travel destination.....129	26	Smile timer.....62, 64
12	Date imprint.....133	27	Blink proof icon.....64
13	Movie options.....108	28	Color options.....43
14	Image mode.....37	29	White balance mode.....39
15	a Number of exposures remaining (still pictures).....22	30	Continuous shooting mode.....41
	b Movie length.....106	31	Self-timer indicator.....32

* Differs according to the current shooting mode.

Playback

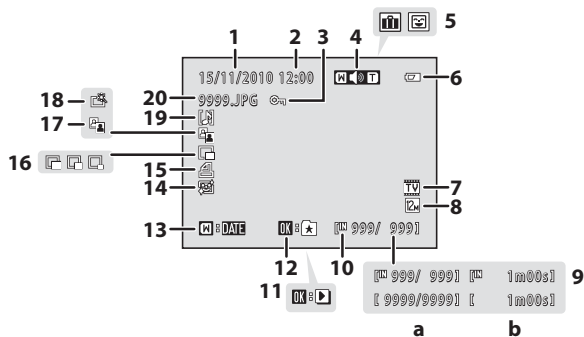

1	Date of recording.....	18	10	Internal memory indicator.....	28
2	Time of recording.....	18	11	Movie playback guide.....	110
3	Protect icon.....	94	12	Add to favorite pictures guide.....	74
4	Volume indicator.....	96, 110	13	List by date guide.....	83
5	Album icon in favorite pictures mode ¹	75	14	Skin softening icon.....	102
	Category icon in auto sort mode ¹	80	15	Print set icon.....	87
6	Battery level indicator.....	22	16	Small picture icon.....	104
7	Movie options ²	108	17	D-Lighting icon.....	101
8	Image mode ²	37	18	Quick retouch icon.....	100
9	a Current frame number/ total number of frames.....	28	19	Voice memo icon.....	96
	b Movie length.....	110	20	File number and type.....	151



¹ The icon for the album or the selected category in auto sort mode currently selected in playback mode is displayed.

² Differs according to the settings configured during shooting.

Basic Operations





The (Shooting Mode) Button



- Press the  button in playback mode to enter shooting mode.
- Press the  button in shooting mode to display the shooting-mode selection menu and switch shooting modes ( 35).

The (Playback) Button



- Press the  button in shooting mode to enter playback mode.
- Press the  button in playback mode to display the playback-mode selection menu and switch playback modes ( 73).
- If the camera is turned off, hold down the  button to turn the camera on in playback mode.

The Multi Selector

This section describes standard uses of the multi selector to select modes, select menu options and to apply selection.

Press the multi selector up, down, left, or right to select options, or press the **OK** (apply selection) button.

Shooting

Display  (flash mode) (book 30) menu or move cursor up

Display  (self-timer) (book 32) menu



Display  (exposure compensation) (book 34) guide

Apply selection

Display  (macro mode) (book 33) menu or move cursor down

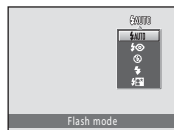

Playback

Select previous picture

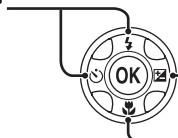

Select next picture

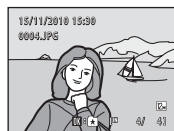

Menu Screen

Move cursor up

Move cursor left or return to the previous screen

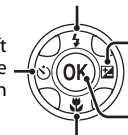

Move cursor right or go to next screen (apply selection)

Apply selection (go to the next screen)

Move cursor down

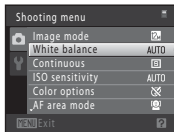
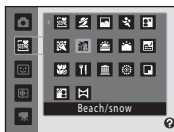

Note on the Multi Selector

In the manual, the button indicating up, down, left and right of the multi selector is shown as ▲, ▼, ◀ and ▶.

The MENU Button

Press the **MENU** button to display the menu for the selected mode.

- Use the multi selector to navigate the menus (9).
- Choose a tab on the left to switch to the menu of the selected tab.
- Press the **MENU** button again to exit the menu.

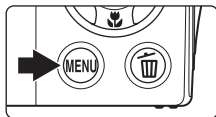

Display the available menus in the current mode

Display the setup menu

Displayed when the menu contains two or more pages

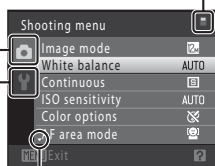

Displayed when there are one or more menu items to follow

Displayed when previous menu items are available



Choose an option and press the **OK** button or the multi selector **▶** to proceed to the next set of options

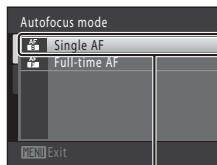

Press the **OK** button or the multi selector **▶** to apply selection

Switching Between Tabs

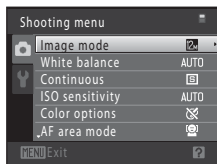

Press the multi selector **◀** to highlight the tab

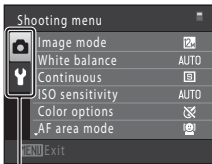

Press the multi selector **▲** or **▼** to select a tab, and press either the **OK** button or **▶**

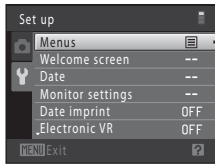

The selected menu is displayed

Help Displays

Rotate the zoom control to **T** (?) when **[?]/[?]** is displayed at the lower right of the menu screen to view a description of the currently selected menu option.

To return to the original menu, rotate the zoom control to **T** (?) again.

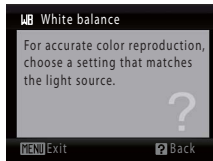
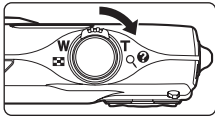

The Shutter-release Button

The camera features a two-stage shutter-release button. To set focus and exposure, press the shutter-release button halfway, stopping when you feel resistance. Focus and exposure lock while the shutter-release button is held in this position. To release the shutter and take a picture, press the shutter-release button the rest of the way down. Do not use force when pressing the shutter-release button, as this may result in camera shake and blurred pictures.



Press the shutter-release button halfway to set focus and exposure

Press the shutter-release button the rest of the way down to take picture

Attaching the Camera Strap

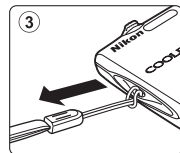
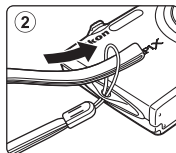
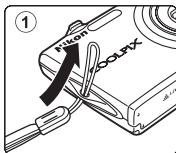

Inserting the Battery

Insert a Rechargeable Li-ion Battery EN-EL10 (supplied) into the camera.

- Charge the battery before the first use or when the battery is running low (📖 14).

- 1 Open the battery-chamber/memory card slot cover.

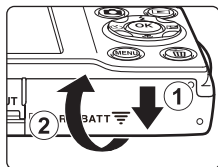

- 2 Insert the battery.

Confirm that the battery's positive (+) and negative (-) terminals are oriented correctly as shown on the label at the battery chamber opening, and insert the battery.

Use the battery to push the orange battery latch up (①) as the battery is inserted (②).

When the battery is fully inserted, the battery latch will lock it in place.

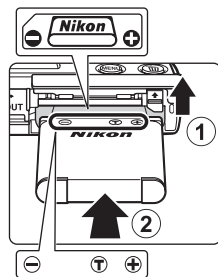

✔ Inserting the Battery

Inserting the battery upside down or backwards could damage the camera. Be sure to check that the battery is in the correct orientation.

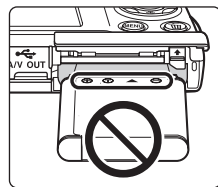

- 3 Close the battery-chamber/memory card slot cover.

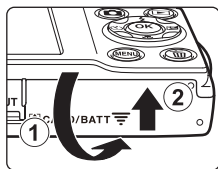

Removing the Battery

Turn the camera off (📖 17) and be sure that the power-on lamp and the monitor have turned off before opening the battery-chamber/memory card slot cover.

To eject the battery, open the battery-chamber/memory card slot cover and slide the orange battery latch in the direction indicated by the arrow (①). The battery can then be removed by hand (②).

- Note that the battery may become hot during use; observe due caution when removing the battery.

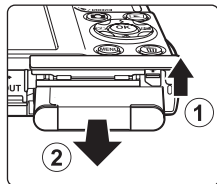

✓ Notes on the Battery

- Be sure to read and follow the warnings for the battery on page iii and the section, “The Battery” (📖 147), before using the battery.
- If the battery is not used for an extended period, recharge it at least once every six months and completely exhaust it before returning it to storage.

Charging the Battery

Charge the supplied Rechargeable Li-ion Battery EN-EL10 inserted into the camera, by connecting the supplied Charging AC Adapter EH-68P to the camera via the supplied USB Cable UC-E6, and then plugging the Charging AC Adapter into an electrical outlet.

1 Prepare the Charging AC Adapter EH-68P.

If a plug adapter* is included, attach the plug adapter to the plug on the Charging AC adapter. Push the plug adapter firmly until it is securely held in place. Once the two are connected, attempting to forcibly remove the plug adapter could damage the product.

* The shape of the plug adapter varies according to the country or region in which the camera was purchased.

For Customers in Argentina

If the camera was purchased in Argentina, the shape of the Charging AC Adapter EH-68P (AR) differs from that supplied in other countries, and a plug adapter is not included. Proceed to step 2.

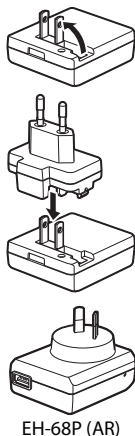

2 Be sure that the power-on lamp and the monitor are off.

Be sure to insert the battery into the camera (📖 12) and turn off the camera (📖 17).

3 Use the supplied USB cable to connect the Charging AC Adapter to the camera.

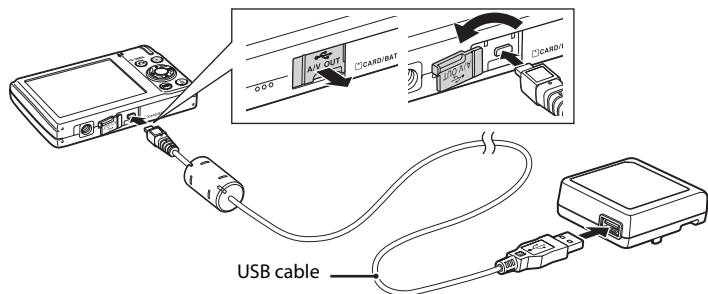

✓ Connecting the Cable

When connecting the cable, be sure that the camera connector is properly oriented. Do not use force when connecting the cable to the camera. When disconnecting the cable, do not pull the connector at an angle.

4 Plug the Charging AC Adapter into an electrical outlet.

The charge lamp slowly blinks green to indicate that the battery is charging.

About two hours and ten minutes are required to charge a fully exhausted battery.

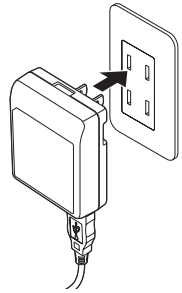

The following chart explains charge lamp status when the camera is plugged into the electrical outlet.



Charge lamp	Description
Blinks slowly (green)	Battery charging.
Off	Battery not charging. When charging is complete, the charge lamp stops blinking green and turns off.
Flickers (green)	<ul style="list-style-type: none"> The ambient temperature is not suited to charging. Charge the battery indoors with an ambient temperature of 5 °C to 35 °C (41 °F to 95 °F). The USB cable or Charging AC Adapter is not properly connected, or there is a problem with the battery. Disconnect the USB cable or unplug the Charging AC Adapter and correctly connect it again, or change the battery.

5 Disconnect the Charging AC Adapter from the electrical outlet and then disconnect the USB cable.

Charging the Battery

Notes on Charging AC Adapter

- The Charging AC Adapter EH-68P is for use only with compatible devices. Do not use with another make or model of device.
- Be sure to read and follow the warnings for the Charging AC Adapter on page iii and the section, “The Battery” (📖 147), before use.
- The EH-68P is compatible with AC 100-240 V, 50/60 Hz electrical outlets. When using in other countries, use a third-party plug adapter as necessary. For more information about plug adapters, consult your travel agency.
- The Charging AC Adapter EH-68P is for charging the battery inserted into the camera. When the camera is connected to an electrical outlet with the Charging AC adapter, the camera cannot be turned on.
- Do not, under any circumstances, use another make or model of AC adapter other than Charging AC Adapter EH-68P or USB-AC adapter. Failure to observe this precaution could result in overheating or in damage to the camera.

AC Power Supply

- If the AC Adapter EH-62D (available separately; 📖 149) is used, power is supplied to the camera from an electrical outlet and taking pictures and playing back pictures are available with this camera.
- Do not, under any circumstances, use another make or model of AC adapter other than EH-62D. Failure to observe this precaution could result in overheating or in damage to the camera.

Charging Using Computer or Battery Charger



- Connecting the COOLPIX S205 to a computer also charges the Rechargeable Li-ion Battery EN-EL10 (📖 112, 140).
- Rechargeable Li-ion Battery EN-EL10 can also be charged using the Battery Charger MH-63 (available separately; 📖 149).

Turning On and Off the Camera

To turn on the camera, press the power switch. The power-on lamp (green) will light for a moment and the monitor will turn on.

To turn off the camera, press the power switch again.



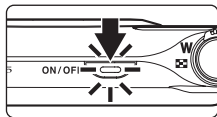

When the camera is turned off, both the power-on lamp and monitor will turn off.

- If the camera is turned off, hold down the  button to turn the camera on in playback mode ( 29).



Power Saving Function (Auto Off)

If no operations are performed for a while, the monitor will turn off automatically, the camera will enter standby mode, and the power-on lamp will blink. If no operations are performed for another three minutes, the camera will turn off automatically.

- If no operations are performed for about a minute (default setting) in shooting or playback mode, the camera will enter standby mode.
- When the monitor has turned off in standby mode (the power-on lamp is blinking), press the following button to reactivate it.
 - Power switch, shutter-release button,  button, or  button
- The time allowed to elapse before the camera enters standby mode can be changed from the **Auto off** option ( 137) in the setup menu ( 125).

Setting Display Language, Date and Time

A language-selection dialog is displayed the first time the camera is turned on.

1 Press the power switch to turn on the camera.

The power-on lamp (green) will light for a moment and the monitor will turn on.

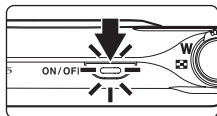

2 Use the multi selector to choose the desired language and press the **OK** button.

For information on using the multi selector, see "The Multi Selector" (📖 9).



3 Choose **Yes** and press the **OK** button.

If **No** is selected, the date and time will not be set.

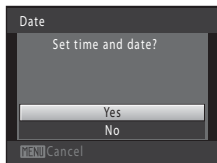

4 Press the multi selector **◀** or **▶** to select your home time zone (📖 131) and press the **OK** button.

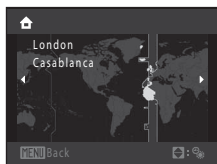

Daylight Saving Time

If daylight saving time is in effect, press the multi selector **▲** in the time zone selection screen displayed in step 4 to turn on the daylight saving time option.

When the daylight saving time option is enabled,  is displayed at the top of the monitor. To turn off the daylight saving time option, press **▼**.

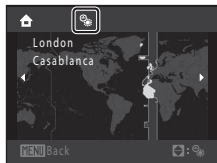

5 Edit the date and time.

Press ▲ or ▼ to edit the highlighted item.

Press ► to move the highlight in the following order.

D (day) → **M** (month) → **Y** (year) → hour → minute → **DMY** (the order in which the day, month, and year are displayed)

Press ◀ to return to the previous item.

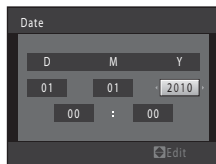

6 Choose the order in which the day, month and year are displayed and press the **OK** button or press ►.

The settings are applied and monitor display exits to shooting mode.

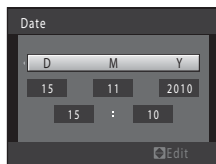

Changing and Imprinting the Date and Time

- Select **Date** from the **Date** item (📖 129) in the setup menu (📖 125) to change the current date and time and follow the procedure described from step 5.
- Select **Time zone** from the **Date** item in the setup menu to change the time zone and daylight saving time settings (📖 129).
- To imprint the date on pictures, enable date imprint from the **Date imprint** option (📖 133) in the setup menu after the date and time have been set.

Inserting Memory Cards

Image, sound, and movie files are stored in the camera's internal memory (approximately 47 MB) or on removable Secure Digital (SD) memory cards (available separately;  150).

If a memory card is inserted in the camera, data are automatically stored on the memory card and data recorded to the memory card can be played back, deleted or transferred. Remove the memory card to store data in the internal memory, or play back, delete or transfer data from the internal memory.

- 1** Be sure that the power-on lamp and the monitor are off and open the battery-chamber/memory card slot cover.

Be sure to turn off the camera before opening the battery-chamber/memory card slot cover.

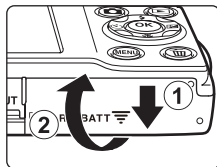

- 2** Insert the memory card.

Slide the memory card in correctly until it clicks into place.

Close the battery-chamber/memory card slot cover.

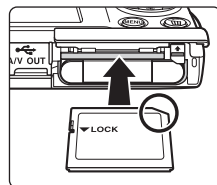

Inserting Memory Cards

Inserting the memory card upside down or backwards could damage the camera or the memory card. Be sure to check that the memory card is in the correct orientation.

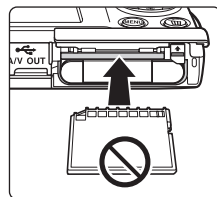

Removing Memory Cards

Before removing memory cards, turn the camera off and confirm that the power-on lamp and monitor are off. Open the battery-chamber/memory card slot cover and press the card in (1) to partially eject the card. The card can then be removed by hand. Do not attempt to remove the card at an angle (2).

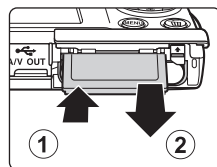

✓ Formatting Memory Cards

If the message at right is displayed, the memory card must be formatted before use (📖 138). Note that **formatting permanently deletes all pictures and other data on the memory card**. Be sure to make copies of any pictures you wish to keep before formatting the memory card.

When formatting the memory card, use the multi selector to choose **Yes** and press the **OK** button. The confirmation dialog will be displayed. To start formatting, choose **Format** and press the **OK** button.

- Do not turn the camera off or open the battery-chamber/memory card slot cover until formatting is complete.
- Be sure to use this camera to format memory cards previously used in other devices the first time they are inserted into the COOLPIX S205 (📖 138).

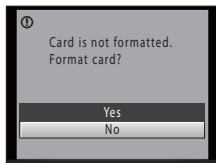

✓ The Write Protect Switch

Memory cards are equipped with a write protect switch. When this switch is in the "lock" position, data cannot be written to, or deleted from, the memory card. If the switch is in the "lock" position, unlock it by sliding the switch to the "write" position to record or delete pictures, or to format the memory card.

Write protect switch

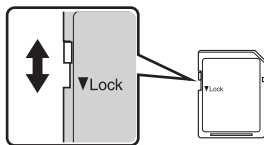

✓ Memory Cards

- Use only Secure Digital memory cards.
- Do not perform the following during formatting, while data is being written to or deleted from the memory card, or during data transfer to a computer. Failure to observe this precaution could result in the loss of data or in damage to the camera or memory card:
 - Take out the battery or memory card
 - Turn off the camera
 - Disconnect the AC adapter
- Do not format the memory card using a computer.
- Do not disassemble or modify.
- Do not drop, bend, or expose to water or strong physical shock.
- Do not touch the metal terminals with your fingers or metal objects.
- Do not affix labels or stickers to the memory card.
- Do not leave in direct sunlight, closed vehicles or areas exposed to high temperatures.
- Do not expose to humidity, dust, or corrosive gases.



Step 1 Turn the Camera On and Select  (Auto) Mode

This section describes taking pictures in  (auto) mode, an automatic, “point-and-shoot” mode recommended for first-time users of digital cameras.

1 Press the power switch to turn on the camera.

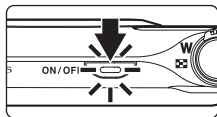

The power-on lamp (green) will light for a moment and the monitor will turn on. The lens will also extend.

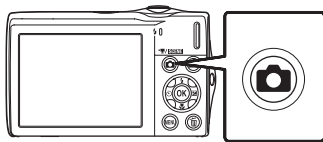
Proceed to step 4 when  is displayed.

**2 Press the  button to display the shooting menu.****3 Press the multi selector  or  to choose  and press the  button.**

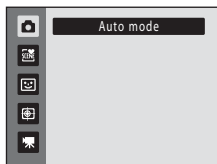
The camera enters  (auto) mode.

**4 Check the battery level and the number of exposures remaining.****Battery Level**

Monitor	Description
NO INDICATOR	Battery fully charged.
	Battery low. Prepare to charge or replace the battery.
 Battery exhausted.	Cannot take pictures. Recharge or replace with a fully charged battery.

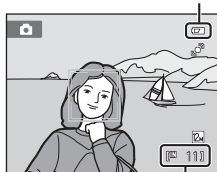
Battery level indicator**Number of exposures remaining****Number of Exposures Remaining**

The number of pictures that can be stored depends on the capacity of the internal memory or memory card and image mode setting ( 38).

Indicators Displayed in (Auto) Mode

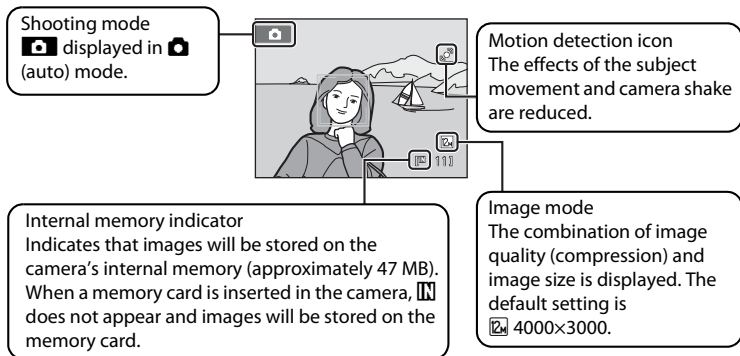

- The indicators and photo info displayed during shooting and playback will turn off after a few seconds (📖 132).
- When the monitor has turned off in standby mode to save power, press the following button to reactivate it (📖 137).
 - Power switch, the shutter-release button, or  button





Functions Available in (Auto) Mode

- The flash mode (📖 30) can be adjusted and the self-timer (📖 32), macro mode (📖 33), and the exposure compensation (📖 34) can be applied.
- Press the **MENU** button to specify settings for all shooting menu items (📖 36) according to shooting conditions.

Motion Detection

See **Motion detection** (📖 135) in the setup menu (📖 125) for more information.

Electronic Vibration Reduction

- When the flash mode (📖 30) is set to  (off) or  (slow sync) with **Electronic VR** (📖 134) in the setup menu set to **Auto**, the  icon may appear in the monitor.
- The appearance of  indicates shooting conditions in which the effects of camera shake can be pronounced. In these situations, the camera reduces the effects of camera shake in pictures before recording them.

Step 2 Frame a Picture

1 Ready the camera.

Hold the camera steadily in both hands, keeping your fingers and other objects away from the lens, flash, AF assist-illuminator, microphone, and speaker.

When taking pictures in portrait (“tall”) orientation, turn the camera so that the built-in flash is above the lens.

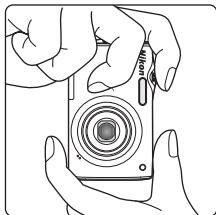
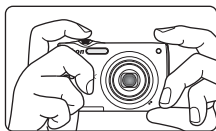

2 Frame the picture.

At the default settings, a face recognized by the camera will be framed by a yellow double border (focus area).

Up to 12 faces can be recognized. If more than one face is recognized, the face closest to the camera will be framed by a double border, and the others by a single border.

When taking pictures of subjects other than people, or framing a subject with which no face is recognized, a focus area will not be displayed. Frame the picture so that the intended subject is at or near the center of the frame.



Using the Zoom

Use the zoom control to activate optical zoom. Rotate the zoom control to **T** to zoom in so that the subject fills a larger area of the frame, or **W** to zoom out, thus increasing the area visible in the frame.

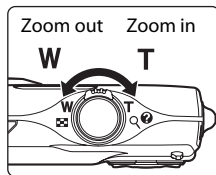

A zoom indicator is displayed at the top of the monitor when the zoom control is rotated.

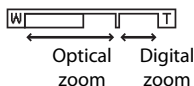

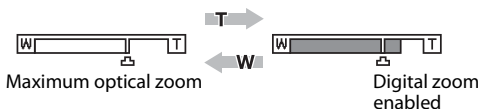

Digital Zoom

When the camera is zoomed in to the maximum optical zoom position, rotating and holding the zoom control at **T** triggers digital zoom. The subject is magnified up to 4x the maximum optical zoom ratio. The camera focuses at the center of the frame and the focus area is not displayed when digital zoom is in effect.



Digital Zoom and Interpolation

Unlike optical zoom, digital zoom uses a digital imaging process known as interpolation to magnify images, resulting in slight deterioration of picture quality according to the image mode (📖 37) and digital zoom magnification.

Interpolation is applied at zoom positions beyond  when taking still pictures. When zoom is increased beyond the  position, interpolation is initiated and the zoom indicator turns yellow to indicate that interpolation is being applied. The position of  moves to the right as image size decreases, allowing for confirmation of the zoom positions at which shooting without interpolation is possible at the current image mode setting.



Digital zoom can be disabled from the **Digital zoom** option (📖 136) in the setup menu (📖 125).

Step 3 Focus and Shoot

1 Press the shutter-release button halfway.

Press the shutter-release button halfway (📖 11) to focus.

When a face is recognized, it is framed by the double border indicating the active focus area. When the subject is in focus, the double border turns green.

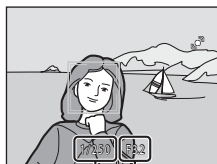
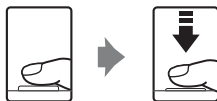

Shutter speed Aperture

When a face is not recognized, camera automatically selects the focus area (up to nine areas) containing the subject closest to the camera. When the subject is in focus, the active focus area glows green.

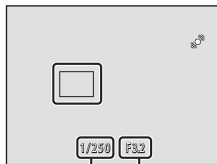

Shutter speed Aperture

When digital zoom is used, the focus area is not displayed and the camera focuses at the center of the frame. Once focus has been acquired, the focus indicator (📖 6) turns green.

When the shutter-release button is pressed halfway, the shutter speed and aperture values also appear.

Focus and exposure remain locked while the shutter-release button is pressed halfway.

While the shutter-release button is pressed halfway, the focus area or focus indicator may blink red. This indicates that the camera is unable to focus. Modify the composition and press the shutter-release button halfway again.

2 Press the shutter-release button the rest of the way down.

The shutter is released and the picture will be recorded to the memory card or internal memory.



During Recording

While pictures are being recorded, the number of exposures remaining will blink. **Do not open the battery-chamber/memory card slot cover** while pictures are being recorded. Cutting power or removing the memory card in these circumstances could result in loss of data or in damage to the camera or card.

Autofocus

Autofocus may not perform as expected in the following situations. In some rare cases, the subject may not be in focus despite the fact that the focus area or the focus indicator glows green:



- Subject is very dark
- Objects of sharply differing brightness are included in the scene (e.g. the sun behind the subject makes that subject appear very dark)
- No contrast between the subject and surroundings (e.g. a portrait subject, wearing a white shirt, is standing in front of a white wall)
- Several objects are at different distances from the camera (e.g. the subject is inside a cage)
- Subject is moving rapidly

In the situations noted above, try pressing the shutter-release button halfway to refocus several times, or focus on another subject and use focus lock ( 45). When using focus lock, be sure that the distance between the camera and the subject with which focus was locked is the same as that for the actual subject.



Note on Face Priority

See **AF area mode** ( 44) and “Face Priority” ( 46) for more information.

Blink Warning Screen

When the camera detects that portrait subjects may have blinked when a picture was taken in face priority mode with  **Blink warning** set to **On**, the blink warning screen ( 141) is displayed in the monitor.

AF-assist Illuminator and Flash









If the subject is poorly lit, the AF-assist illuminator ( 136) may light by pressing the shutter-release button halfway, or the flash ( 30) may fire when the shutter-release button is pressed all the way down.

Step 4 Playing Back and Deleting Pictures

Playing Back Pictures (Playback Mode)



Press the  (playback) button.

The last picture taken will be displayed in full-frame playback mode.

Press the multi selector , ,  or  to view additional pictures. Continue holding down the multi selector , ,  or  to cycle quickly through pictures.

Pictures may be displayed briefly at low resolution while being read from the memory card or internal memory.

Press the  button or the shutter-release button to switch to shooting mode.

When playing back pictures stored in the camera's internal memory,  is displayed. When a memory card is inserted in the camera,  is not displayed and images stored on the memory card are played back.

 (playback) button

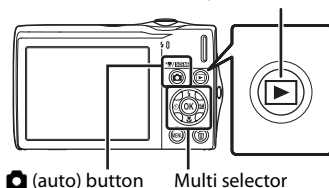

 (auto) button

Multi selector

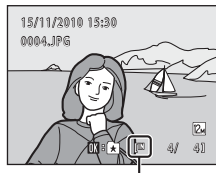

Internal memory indicator

Deleting Pictures

- 1 Press the  button to delete the picture currently displayed in the monitor.

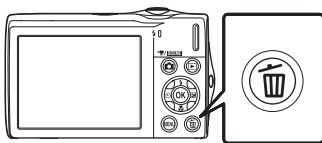

- 2 Use the multi selector to select **Yes** and press the  button.

Deleted pictures cannot be restored.

To exit without deleting the picture, select **No** and press the  button.



Operations Available in Playback Mode

See “Operations in Full-frame Playback Mode” (📖 68) and “Editing Pictures” (📖 98) for more information.

Pressing the Button to Turn On the Camera

When the camera is off, holding down the  button will turn the camera on in playback mode. The lens will not extend.

Viewing Pictures

- When pictures in which a face was recognized during shooting (📖 46) are displayed in full-frame playback, depending upon the orientation of the recognized face, the pictures may be automatically rotated for playback display except pictures taken with **Continuous**, **BSS**, and **Multi-shot 16** setting (📖 41).
- When the monitor has turned off in standby mode to save power, press the following button to reactivate it (📖 137).
 - Power switch, the shutter-release button, or  button

Deleting the Last Picture Taken While in Shooting Mode

In shooting mode, press the  button to delete the last picture taken.

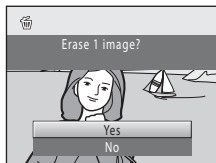

Deleting Multiple Pictures

Multiple pictures can be deleted from the **Delete** option (📖 92) in the playback menu (📖 86), the list by date menu (📖 85), the auto sort menu (📖 82), or the favorite pictures menu (📖 77).

Using the Flash

When **ISO sensitivity** is set to **Auto**, the flash has a range of 0.5–4.5 m (1 ft. 8 in.–14 ft.) at the maximum wide-angle zoom position and a range of 0.5–2.4 m (1 ft. 8 in.–7 ft. 10 in.) at the maximum telephoto zoom position.

AUTO Auto

Flash fires automatically when lighting is dim.

Auto with red-eye reduction

Reduce “red-eye” in portraits ( 31).

Off

Flash will not fire even when lighting is dim.

Fill flash

Flash fires whenever a picture is taken. Use to “fill-in” (illuminate) shadows and backlit subjects.

Slow sync

 **AUTO** (auto) is combined with slow shutter speed.

Suited to evening and night portraits that include background scenery. Flash illuminates main subject; slow shutter speeds are used to capture background at night or under dim lighting.

Setting the Flash Mode

1 Press the multi selector (flash mode).

The flash menu is displayed.



2 Press the multi selector or to choose the desired flash mode and press the button.

The icon for the selected flash mode is displayed at the top of the monitor.

When  **AUTO** (auto) is applied,  **AUTO** is only displayed for a few seconds, regardless of **Photo info** settings ( 132).

If a setting is not applied by pressing the  button within a few seconds, the selection will be canceled.

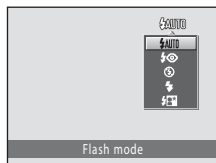

✓ Shooting When the Flash Is Disabled (🚫) or Lighting Is Poor

- Use of a tripod is recommended to stabilize the camera during shooting and avoid the effects of camera shake.
- The **ISO** indicator is displayed when the camera automatically increases sensitivity. Pictures taken when **ISO** is displayed may be slightly mottled.
- The noise reduction function may be activated with some shooting conditions such as dim lighting. More time than usual is required to record pictures to which noise reduction is applied.

✓ Note on the Flash

When using the flash, reflections from dust particles in the air may appear as bright spots in pictures. To reduce these reflections, set the flash to 🚫 (off).

📎 The Flash Lamp

The flash lamp indicates flash status when the shutter-release button is pressed halfway.

- On: Flash will fire when picture is taken.
- Blinks: Flash charging. Wait a few seconds and try again.
- Off: Flash will not fire when picture is taken.

If the battery is low, the monitor display will turn off, and remain off, until the flash is fully charged.

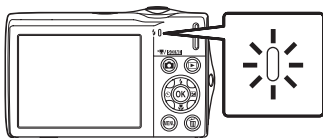

📎 The Flash Mode Setting

The default flash mode setting varies with shooting mode.

- 📷 (auto): ⚡AUTO (auto)
- Scene: varies with the selected scene mode (📖 53–59)
- 📸 (smart portrait): fixed at ⚡AUTO (auto) when **Off** is selected for **Blink proof**; 🚫 (off) when **On** is selected for **Blink proof** (📖 64)
- 🎯 (subject tracking): ⚡AUTO (auto)

There may be functions with which the flash cannot be enabled. See “Camera Settings that Cannot Be Applied Simultaneously” (📖 49) for more information.

The flash mode setting applied in 📷 (auto) mode is stored in the camera’s memory even after the camera is turned off, and reapplied the next time 📷 (auto) mode is selected.

📎 Red-eye Reduction

This camera uses advanced red-eye reduction (“In-Camera Red-Eye Fix”).

If the camera detects “red eye” while a picture is being recorded, the affected area will be processed to reduce red-eye before the picture is saved. Note the followings when shooting.

- More time than usual is required to record pictures.
- Red-eye reduction may not produce the desired results in all situations.
- In extremely rare instances, areas not subject to red-eye may be affected by red-eye reduction processing; in these cases, choose another flash mode and try again.

Taking Pictures with the Self-timer

The camera is equipped with a ten-second and two-second timer for self-portraits. This feature is useful for reducing the effects of camera shake that occurs when pressing the shutter-release button.

When using the self-timer, use of a tripod is recommended.

1 Press the multi selector (self-timer).

The self-timer menu is displayed.



2 Press the multi selector or to choose **10 s** or **2 s** and press the button.

10 s (ten seconds): Use on important occasions, such as weddings

2 s (two seconds): Use to prevent camera shake

The mode selected for self-timer is displayed.

If a setting is not applied by pressing the  button within a few seconds, the selection will be canceled.

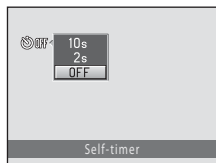

3 Frame the picture and press the shutter-release button halfway.

Focus and exposure will be set.

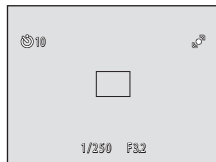

4 Press the shutter-release button the rest of the way down.

The self-timer starts, and the number of seconds remaining before the shutter is released is displayed in the monitor. The self-timer lamp blinks while the timer is counting down. About one second before the shutter is released, the lamp stops blinking and glows steadily.

When the shutter is released, the self-timer will be set to **OFF**.

To stop the timer before a picture is taken, press the shutter-release button again.

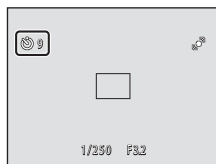

Macro Mode

Macro mode is used for taking pictures of objects as close as 8 cm (3.2 in.). Note that the flash may be unable to light the entire subject at distances of less than 50 cm (1 ft. 8 in.).

1 Press the multi selector (macro mode).

The macro menu is displayed.





2 Press the multi selector or to choose **ON** and press the button.

The macro mode icon () is displayed.

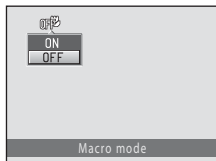
If a setting is not applied by pressing the  button within a few seconds, the selection will be canceled.



3 Rotate the zoom control to frame the picture.

- The closest distance at which the camera can focus varies depending on the zoom position. The camera can focus at the shortest distances when  and the zoom indicator glow green with the zoom indicator positioned to the left (wider angle) of .
- At the zoom position one step to the right (telephoto) of the maximum wide-angle zoom position, the camera can focus on subjects as close as 8 cm (3.2 in.) to the lens. At the maximum wide-angle zoom position and  zoom position, the camera can focus at a distance of 20 cm (8 in.).

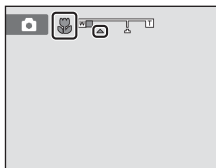



Autofocus

When using  (auto) mode, if **Autofocus mode** ( 48) is set to **Full-time AF**, the camera focuses continuously until focus is locked when the shutter-release button is pressed halfway. Therefore, the sound of lens drive movement can be heard.

When using other shooting modes, **Full-time AF** is turned on automatically when macro mode is turned on.

The Macro Mode Setting

The macro mode setting applied in  (auto) mode is stored in the camera's memory even after the camera is turned off, and reapplied the next time  (auto) mode is selected.



Adjusting Brightness (Exposure Compensation)

Exposure compensation is used to alter exposure from the value suggested by the camera to make pictures brighter or darker.

- 1 Press the multi selector  (exposure compensation).

The exposure compensation guide is displayed.



- 2 Press the multi selector  or  to adjust exposure and press the  button.

To make the picture brighter, apply positive (+) exposure compensation.

To make the picture darker, apply negative (-) exposure compensation.

Exposure compensation can be set to values between -2.0 and +2.0 EV.

If a setting is not applied by pressing the  button within a few seconds, the selection will be canceled.

When an exposure compensation value other than **0.0** is applied, the value is displayed with the  indicator in the monitor.

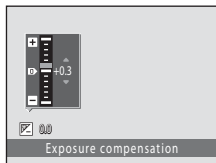

- 3 Press the shutter-release button to take a picture.

To exit without altering exposure, return to step 1, change the value to **0.0** and press the  button.

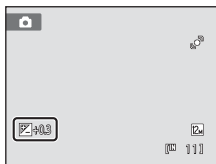





Exposure Compensation Value

The exposure compensation value applied in  (auto) mode is stored in the camera's memory even after the camera is turned off, and reapplied the next time  (auto) mode is selected.

Using Exposure Compensation

- The camera tends to reduce exposure when the frame is dominated by brightly lit objects and to increase exposure when the frame is mostly dark. *Positive (+)* compensation may therefore be required to capture the brilliancy of very bright objects that fill the frame (for example, sunlit expanses of water, sand, or snow) or when the background is much brighter than the main subject.
- *Negative (-)* compensation may be called for when large areas of the frame contain very dark objects (for example, a swath of dark green leaves) or when the background is much darker than the main subject.



Selecting a Shooting Mode

Select a shooting mode from  (auto),  (scene),  (smart portrait),  (subject tracking), and  (movie) modes.



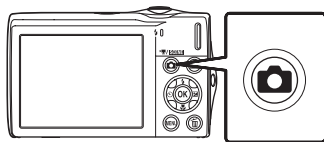



- 1 Press the  button in shooting mode.

The shooting-mode selection menu is displayed.



- 2 Press the multi selector  or  to select a shooting mode and press the  button.

The camera enters the selected shooting mode.

To select a different scene mode (the second icon from the top), press , press the multi selector , , , or  to select a scene and then press the  button.

To return to the current shooting mode without switching shooting modes, press the  button or the shutter-release button.

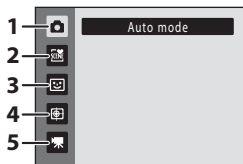

1 Auto mode

 22

Pictures can be taken with an automatic, “point-and-shoot” mode recommended for first-time users of digital cameras. Shooting settings such as continuous shooting can be applied from the shooting menu ( 36).

2 Scene mode

 50

Camera settings are automatically optimized for the selected scene. In scene auto selector mode, the camera automatically selects the optimum scene mode for simpler shooting.

3 Smart Portrait

 62

The camera uses face priority to recognize human faces, and then automatically releases the shutter when a smile is detected. The skin softening option can be used to make skin tones of human faces displayed smoothly.

4 Subject Tracking

 65

Suited to focus and take pictures of moving subjects.

5 Movie

 106

Movie (with sound) can be taken.

Shooting Options: The Shooting Menu (📷 (Auto) Mode)

The following options can be set when shooting in 📷 (auto) mode (📖 22).

🔍	Image mode	📖 37
	Choose the image mode (combination of image size and compression rate) at which pictures are recorded. The image mode setting can also be modified from other shooting modes (except the movie mode).	
WB	White balance	📖 39
	Match white balance to the light source.	
📷	Continuous	📖 41
	Enable continuous shooting or BSS (best shot selector).	
ISO	ISO sensitivity	📖 42
	Control the camera's sensitivity to light.	
🎨	Color options	📖 43
	Apply color effects to pictures as they are recorded.	
[+]	AF area mode	📖 44
	Choose how the camera selects the focus area for autofocus.	
🔍	Autofocus mode	📖 48
	Choose how the camera focuses.	

Displaying the Shooting Menu

Enter 📷 (auto) mode (📖 22).

Press the **MENU** button to display the shooting menu.

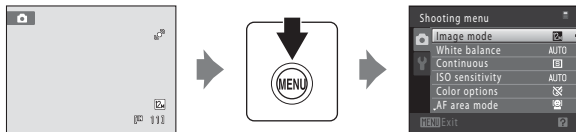

- Use the multi selector to choose and apply settings (📖 9).
- To exit the shooting menu, press the **MENU** button.













✔ Camera Settings that Cannot Be Applied Simultaneously

Some functions cannot be enabled in conjunction with others (📖 49).

🔙 Image Mode (Image Quality/Image Size)

📷 (auto) → MENU (Shooting menu) → 🔙 Image mode

Image mode refers to the combination of image size and image quality (compression) at which pictures are recorded. Choose the image mode best suited to the manner in which pictures will be used and the capacity of the internal memory or memory card. The higher the image mode setting, the larger the size at which it can be printed or displayed without appearing noticeably “grainy,” but limiting the number of pictures that can be recorded.

Option	Size (pixels)	Description
 4000×3000★	4000 × 3000	Higher quality than  , suitable for enlargements or high-quality prints. The compression ratio is approximately 1:4.
 4000×3000 (default setting)	4000 × 3000	Best choice in most situations. The compression ratio is approximately 1:8.
 3264×2448	3264 × 2448	
 2592×1944	2592 × 1944	
 2048×1536	2048 × 1536	Smaller size than  ,  , or  allows more pictures to be stored. The compression ratio is approximately 1:8.
 1024×768	1024 × 768	Suited to display on a computer monitor. The compression ratio is approximately 1:8.
 640×480	640 × 480	Suited to full-screen display on a television with an aspect ratio of 4:3, or distribution by e-mail. The compression ratio is approximately 1:8.
 3968×2232	3968 × 2232	Pictures with an aspect ratio of 16:9 are recorded. The compression ratio is approximately 1:8.









The icon for the current setting is displayed in the monitor in shooting and playback modes (📖 6, 7).

Image Mode

- Change made to this setting applies to all shooting modes (except the movie mode).
- There may be functions with which this setting cannot be enabled. See “Camera Settings that Cannot Be Applied Simultaneously” (📖 49) for more information.

Number of Exposures Remaining

The following table lists the approximate number of pictures that can be stored in internal memory and on a 4 GB memory card. Note that the number of pictures that can be stored will differ depending on the composition of the picture (due to JPEG compression). In addition, this number may vary depending on the make of memory card, even when the memory cards have the same specified capacity.

Setting	Internal memory (approx. 47 MB)	Memory card ¹ (4 GB)	Print size ² (cm/in.)
 4000×3000★	5	505	34 × 25/13 × 10
 4000×3000	11	1010	34 × 25/13 × 10
 3264×2448	18	1575	28 × 21/11 × 8
 2592×1944	29	2565	22 × 16/8.5 × 6.5
 2048×1536	48	4235	17 × 13/7 × 5
 1024×768	142	13500	9 × 7/3.5 × 2.5
 640×480	275	23000	5 × 4/2 × 1.5
 3968×2232	15	1370	34 × 19/13 × 7.5

¹ If the number of exposures remaining is 10,000 or more, the number of exposures remaining display shows “9999”.

² Print size at an output resolution of 300 dpi. Print sizes are calculated by dividing the number of pixels by printer resolution (dpi) and multiplying by 2.54 cm (1 in.). However, at the same image size, pictures printed at higher resolutions will print smaller than the size indicated, and those printed at lower resolutions will print larger than the size indicated.

WB White Balance (Adjusting Hue)

📷 (auto) → MENU (Shooting menu) → WB White balance

The color of light reflected from an object varies with the color of the light source. The human brain is able to adapt to changes in the color of the light source, with the result that white objects appear white whether seen in the shade, direct sunlight, or under incandescent lighting. Digital cameras can mimic this adjustment by processing images according to the color of the light source. This is known as “white balance.” For natural colors, choose a white balance setting that matches the light source before shooting. Although the default setting, **Auto**, can be used under most types of lighting, the white balance setting suited to a particular light source can be specified manually to achieve more accurate results.

AUTO Auto (default setting)

White balance automatically adjusted to suit lighting conditions. Best choice in most situations.

PRE Preset manual

Neutral-colored object used as reference to set white balance under unusual lighting conditions. See “Preset Manual” for more information (📖 40).

☀️ Daylight

White balance adjusted for direct sunlight.

💡 Incandescent

Use under incandescent lighting.

💡 Fluorescent

Use under fluorescent lighting.

☁️ Cloudy

Use when taking pictures under overcast skies.

📷 Flash

Use with the flash.

The effects of the selected option can be previewed in the monitor (📖 6). At settings other than **Auto**, the icon for the current setting is displayed in the monitor.

✔️ **Note on White Balance**

- There may be functions with which this setting cannot be enabled. See “Camera Settings that Cannot Be Applied Simultaneously” (📖 49) for more information.
- At white-balance settings other than **Auto** or **Flash**, turn the flash off (📷) (📖 30).

Preset Manual

Preset manual is effective with mixed lighting or to compensate for light sources with a strong color cast (for example, to make pictures taken under a lamp with a red shade look as though they had been taken under white light).

1 Place a white or gray reference object under the lighting that will be used during shooting.

2 Display shooting menu (📖 36), use the multi-selector to choose **PRE Preset manual** in the **White balance** menu and press the **OK** button.

The camera zooms in.

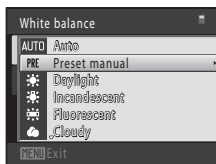

3 Choose **Measure**.

To apply the most recently measured value for preset manual, choose **Cancel** and press the **OK** button.

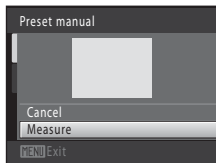

4 Frame the reference object in the measuring window.

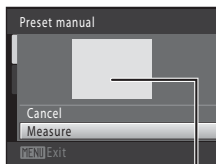

Measuring window

5 Press the **OK** button to measure a value for preset manual.

The shutter is released and the new white-balance value is set. No picture is recorded.

✔ Note on Preset Manual

A value for flash lighting cannot be measured with **Preset manual**. When shooting using the flash, set **White balance** to **Auto** or **Flash**.

📷 Continuous

📷 (auto) → MENU (Shooting menu) → 📷 Continuous

Enable continuous shooting or BSS (best shot selector). The flash is disabled when **Continuous**, **BSS** or **Multi-shot 16** is selected, and focus, exposure and white balance are fixed at the values determined with the first picture in each series.

📷 Single (default setting)

One picture is taken each time the shutter-release button is pressed.

📷 Continuous

While the shutter-release button is held down, up to three pictures are taken at a rate of about 0.9 frames per second (fps) when **Image mode** is set to **📷 4000x3000**.

BSS (Best Shot Selector)

The “best shot selector” is recommended when shooting with the flash off or the camera zoomed in, or in other situations in which inadvertent motion can result in blurred pictures. When BSS is on, the camera takes up to ten pictures while the shutter-release button is held down. The sharpest picture in the series is automatically selected and saved.

📷 Multi-shot 16

Each time the shutter-release button is pressed, camera takes 16 shots at a rate of about 30 fps and arranges them in a single image shots.

- **Image mode** is fixed at **📷** (2560 × 1920).
- Digital zoom is not available.



At settings other than **Single**, the indicator for the current setting is displayed in the monitor (📖 6).

✔ Notes on Continuous Shooting

- The frame rate with continuous shooting may vary depending upon the current image mode setting, the memory card used, or shooting condition.
- There may be functions with which this setting cannot be enabled. See “Camera Settings that Cannot Be Applied Simultaneously” (📖 49) for more information.

✔ Note on BSS

BSS may not produce the desired results if the subject moves or the composition changes while the shutter-release button is held down.

✔ Note on Multi-shot 16

Smear (📖 148) visible in the monitor when shooting with **Multi-shot 16** enabled will be recorded with images. Avoiding bright objects such as the sun, reflections of the sun, and electric lights when shooting with **Multi-shot 16** enabled is recommended.

ISO ISO Sensitivity

📷 (auto) → MENU (Shooting menu) → ISO ISO sensitivity

Sensitivity is a measure of the camera's response to light. The higher the sensitivity, the less light is needed to expose an image. Although high ISO sensitivity settings are suited to pictures of moving subjects or those taken under dim lighting, high sensitivity settings are often associated with "noise" - randomly spaced, brightly colored pixels - concentrated in dark portions of the image.

Auto (default setting)

Sensitivity is ISO 80 when there is sufficient lighting, the camera compensates by raising sensitivity to a maximum of ISO 1600 when lighting is dim.

Fixed range auto

Choose the range in which the camera automatically adjusts ISO sensitivity, from **ISO 80-400** (default setting) or **ISO 80-800**. The camera will not increase sensitivity beyond the maximum value in the selected range. Specify the maximum ISO sensitivity for effective control over the amount of "grain" that appears in images.

80, 100, 200, 400, 800, 1600, 3200

Sensitivity is locked at the specified value.

At the settings other than **Auto**, the current setting is displayed in the monitor (📖 6). If **Auto** is selected and the sensitivity is raised above ISO 80, the **ISO** icon will be displayed (📖 31). When **Fixed range auto** is selected,  and the maximum value of ISO sensitivity is displayed.

✔ Note on ISO sensitivity

- There may be functions with which this setting cannot be enabled. See "Camera Settings that Cannot Be Applied Simultaneously" (📖 49) for more information.
- **Motion detection** (📖 135) does not function when any option other than **Auto** is selected in the ISO sensitivity setting.

🎨 Color Options

📷 (auto) → MENU (Shooting menu) → 🎨 Color options

Make colors more vivid or record pictures in monochrome.

🎨 **Standard color (default setting)**
Use for pictures exhibiting natural color.

🎨 **Vivid color**
Use to achieve a vivid, “photoprint” effect.

🎨 **Black-and-white**
Record pictures in black-and-white.

🎨 **Sepia**
Record pictures in sepia tones.

🎨 **Cyanotype**
Record pictures in cyan-blue monochrome.

At settings other than **Standard color**, the icon for the current setting is displayed in the monitor (📖 6). Color tones in shooting display change according to the selected color option.

📌 Note on Color Options

There may be functions with which this setting cannot be enabled. See “Camera Settings that Cannot Be Applied Simultaneously” (📖 49) for more information.

[+] AF Area Mode

📷 (auto) → MENU (Shooting menu) → [+] AF area mode

Use this option to determine how the camera selects the focus area for autofocus. When digital zoom is in effect, the camera always focuses at the center of the frame regardless of the specified setting.

👤 Face priority (default setting)

When the camera recognizes a human face, it focuses on that face. See "Face Priority" (📖 46) for more information. If more than one face is recognized, the camera focuses on the face closest to the camera.

When taking pictures of subjects other than people, or framing a subject with which no face is recognized, the **AF area mode** setting switches to **Auto**, and the camera will automatically select the focus area containing the subject closest to the camera.

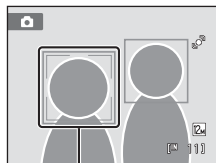

Focus areas

📷 Auto

The camera automatically selects the focus area containing the subject closest to the camera. Press the shutter-release button halfway to activate the focus area. When the shutter-release button is pressed halfway, the focus area (up to nine areas) selected by the camera will be displayed in the monitor.

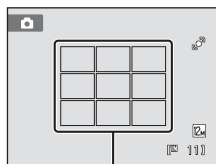

Focus areas

[] Manual

Select one of 99 focus areas displayed in the monitor. This option is suited to situations in which the intended subject is relatively still and not positioned in the center of the frame.

Press the multi-selector ▲, ▼, ◀, or ▶ to select the focus area displayed in the monitor that contains the subject, and shoot.

To cancel focus-area selection and adjust flash, macro mode, self-timer and exposure compensation settings, press the OK button. To return to the focus area selection screen, press the OK button again.

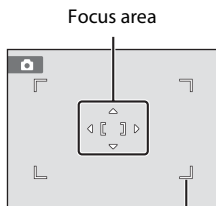

Selectable focus area

Center

The camera focuses on the subject at the center of the frame.
The center focus area is always displayed.

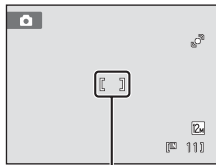

Focus area

✓ Notes on AF Area Mode

This feature cannot be used simultaneously with certain features. See “Camera Settings that Cannot Be Applied Simultaneously” (📖 49).

🔒 Focus Lock

To focus on off-center subjects when **Center** is selected for **AF area mode**, use focus lock as described below.

- 1 Position the subject in the center of the frame.
- 2 Press the shutter-release button halfway.
 - Confirm that the focus area is green.
 - Focus and exposure are locked.
- 3 Continue holding down the shutter-release button halfway and recompose the picture.
 - Be sure that the distance between the camera and the subject does not change.
- 4 Press the shutter-release button the rest of the way down to take the picture.



💡 More Information

See “Autofocus” (📖 27) for more information.

Face Priority

When the camera is pointed at a human face, face recognition, which the camera automatically recognizes that face and focus on it, starts. The face priority function is activated in the following situations.

- **AF area mode** (📖 44) is set to **Face priority**
- In **Scene auto selector** (📖 51), **Portrait** (📖 53) and **Night portrait** (📖 54) scene modes
- In smart portrait mode (📖 62)

1 Frame a picture.

When the camera recognizes a face, that face is framed by a yellow double border.

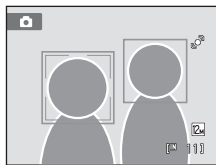

When the camera recognizes more than one face, operation varies as follows depending upon the shooting mode.

Shooting mode	Faces framed by double border	Number of faces that can be recognized
📷 (auto) mode (face priority)	The face closest to the camera	Up to 12
Scene auto selector, Portrait, Night portrait scene mode	<ul style="list-style-type: none"> • Other faces framed by single border. 	
Smart portrait mode	The face closest to the center of the frame <ul style="list-style-type: none"> • Other faces framed by single border. 	Up to 3

2 Press the shutter-release button halfway.

The camera focuses on the face framed by the double border. The double border turns green and focus is locked.

When the camera is unable to focus, the double border will blink. Press the shutter-release button halfway again and focus.

Press the shutter-release button the rest of the way down to take a picture.

If the camera detects that the face framed by the double border is smiling in smart portrait mode, the **Smile timer** (📖 62) is activated and the shutter is automatically released without the shutter-release button having been pressed.



✓ Notes on Face Priority

- If the camera is unable to recognize any faces when the shutter-release button is pressed halfway with **AF area mode** set to **Face priority**, the AF area mode setting automatically switches to **Auto**.
- If no faces are recognized when the shutter-release button is pressed halfway in **Portrait** or **Night portrait** scene mode or smart portrait mode, the camera will focus on the subject at the center of the frame.
- The camera may be unable to recognize faces in the following situations:
 - When faces are partially hidden by sunglasses or otherwise obstructed
 - When faces take up too much or too little of the frame
- When the frame includes more than one face, the faces recognized by the camera and the face on which the camera focuses depend upon a variety of factors, including the direction in which the faces are looking.
- In some rare cases, the subject may not be in focus despite the fact that the double border glows green (📖 27). Should this occur, switch to 📷 (auto) mode and set **AF area mode** to **Manual** or **Center**, refocus on another subject positioned at the same distance from the camera as the actual portrait subject, and use focus lock (📖 45).
- When pictures in which a face was detected during shooting are played back, the pictures will be, automatically rotated for playback display, according to the orientation of the face detected except pictures that were taken using **Continuous**, **BSS** and **Multi-shot 16** (📖 41).

📷 Autofocus Mode

📷 (auto) → MENU (Shooting menu) → 📷 Autofocus mode

Choose how the camera focuses.

 **Single AF (default setting)**

The camera focuses when the shutter-release button is pressed halfway.

 **Full-time AF**

The camera focuses continuously until the shutter-release button is pressed down halfway. Use with moving subjects. The sound of lens drive movement will be heard while the camera focuses.

✔ **Note on the Autofocus Mode Setting for Subject Tracking Mode**

Autofocus mode can be set for subject tracking mode. The default setting in subject tracking mode is **Full-time AF**. **Autofocus mode** can be set independently for both subject tracking mode and 📷 (auto) mode.

Camera Settings that Cannot Be Applied Simultaneously

Some shooting settings cannot be used with other functions.

Restricted function	Setting	Descriptions
🔦 Flash (📖 30)	Continuous (📖 41)	When Continuous , BSS , or Multi-shot 16 is selected, flash is disabled.
📷 Image mode (📖 37)	Continuous (📖 41)	When Multi-shot 16 is selected, the Image mode setting is fixed at 📷 (image size: 2560 × 1920 pixels).
WB White balance (📖 39)	Color options (📖 43)	When Black-and-white , Sepia , or Cyanotype is selected for Color options , the White balance setting is fixed at Auto .
🕒 Continuous (📖 41)	Self-timer (📖 32)	When taking a picture using the self-timer, the continuous setting is fixed to Single .
ISO ISO sensitivity (📖 42)	Continuous (📖 41)	When Multi-shot 16 is selected, the ISO sensitivity setting is automatically specified according to the brightness.
🔍 AF area mode (📖 44)	Digital zoom (📖 136)	When using digital zoom, the camera focuses on the subject at the center of the frame.
📷 Electronic VR (📖 134)	ISO sensitivity (📖 42)	When a setting other than Auto is selected for ISO sensitivity , Electronic VR is disabled.
	Continuous (📖 41)	When shooting with Continuous , BSS , or Multi-shot 16 enabled, electronic VR is disabled.
📷 Motion detection (📖 135)	Continuous (📖 41)	When Multi-shot 16 is selected, Motion detection is not enabled.
	ISO sensitivity (📖 42)	When the option other than Auto is selected for ISO sensitivity, Motion detection is disabled.
📧 Blink warning (📖 141)	Continuous (📖 41)	When taking a picture using Continuous , BSS , or Multi-shot 16 , Blink warning is disabled.
Digital zoom (📖 25, 136)	Continuous (📖 41)	When Multi-shot 16 is selected, digital zoom is not available.

📷 More Information

See "Note on Digital Zoom" (📖 136)

Shooting Suited to Scenes (Scene Mode)

Camera settings are automatically optimized for the selected subject type. The following scene modes are available.

Scene auto selector	Portrait	Landscape	Sports	Night portrait
Party/indoor	Beach/snow	Sunset	Dusk/dawn	Night landscape
Close-up	Food	Museum	Fireworks show	Copy
Backlight	Panorama assist			

Selecting a Scene Mode

- 1 Press the button in shooting mode to display the shooting-mode selection menu and press the multi selector or to select the scene mode icon.

The icon for the last scene mode selected is displayed. The default setting is (Scene auto selector; 51).



- 2 Press the multi selector and press , , , or to choose the desired scene, and then press the button.

The display changes to that for the selected scene mode. For more information about features of scene modes, see page 53.

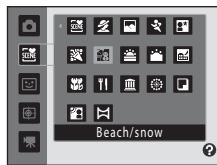

- 3 Frame the subject and take a picture.



Image Mode



When the **MENU** button is pressed in scene mode, **Image mode** (37) can be adjusted. Change made to this setting applies to all shooting modes (except movie recording).

Shooting in the Scene Mode Selected by the Camera (Scene Auto Selector)

By simply framing a picture, the camera automatically selects the optimum scene mode for simpler shooting.

When a picture is framed in  (Scene auto selector) scene mode, the camera automatically adjusts settings for one of the following scene modes:

- Auto (general shooting)
- Portrait (📖 53)
- Landscape (📖 53)
- Night portrait (📖 54)
- Night landscape (📖 56)
- Close-up (📖 56)
- Backlight (📖 58)

- 1 Press the  button in shooting mode to display the shooting-mode selection menu and use the multi selector to select  (Scene auto selector) scene mode (📖 50).

The camera enters scene auto selector mode.

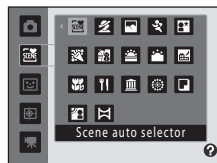

- 2 Frame the subject and take a picture.

When the camera automatically selects a scene mode, the shooting mode icon changes to that for the scene mode currently enabled.

- | | |
|--|---|
|  : Auto |  : Night landscape |
|  : Portrait |  : Close-up |
|  : Landscape |  : Backlight |
|  : Night portrait | |

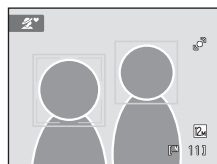



Press the shutter-release button halfway to set focus and exposure. When the subject is in focus, the active focus area glows green.

Press the shutter-release button the rest of the way down to take the picture.





Notes on Scene Auto Selector Scene Mode

- Digital zoom is not available.
- Depending upon shooting conditions, the camera may not select the desired scene mode. Should this occur, switch to  (auto) mode (📖 22) or select the desired scene mode manually (📖 50).

Focusing in Scene Auto Selector Scene Mode

- When the camera recognizes a human face in scene auto selector scene mode, it focuses on that face. See "Face Priority" (📖 46) for more information.
- When the shooting mode indicator  or  is displayed, the camera automatically selects the focus area (one of nine) containing the subject closest to the camera as same as when **Auto** is selected for **AF area mode** (📖 44).

Functions Available in Scene Auto Selector Scene Mode

-  (auto; default setting) and  (off) flash mode settings can be applied (📖 30). When  (auto) is applied, the camera automatically selects the optimum flash mode setting for the scene mode it has selected. When  (off) is applied, the flash does not fire, regardless of shooting conditions.
- Self-timer (📖 32) and exposure compensation (📖 34) settings can be adjusted.
- The macro mode button on the multi selector (📖 9, 33) is disabled.
- When the **MENU** button is pressed in scene auto selector scene mode, **Image mode** (📖 37) can be adjusted. Changes made to the image mode setting apply to all shooting modes (except movie recording).

Selecting a Scene Mode to Take Pictures (Features)

See “Shooting in the Scene Mode Selected by the Camera (Scene Auto Selector)” (📖 51) for more information on scene auto selector scene mode.

The following icons are used for descriptions in this section: ⚡, flash mode (📖 30); ⌚, self-timer (📖 32); 🌸, macro mode (📖 33); 📏, exposure compensation (📖 34).

Portrait

Use this mode for portraits.

- The camera recognizes and focuses on a human face. See “Face Priority” (📖 46) for more information.
- If more than one face is recognized, focus will be on the face nearest to the camera.
- The camera softens skin tones (in up to three faces) by applying the skin softening function before recording pictures (📖 63).
- If no faces are recognized, the camera focuses on the subject at the center of the screen.
- Digital zoom is not available.



* Default setting can be modified.

Landscape

Use this mode for vivid landscapes and cityscapes.

- Camera focuses at infinity. The focus area or focus indicator (📖 6) always glows green when the shutter-release button is pressed halfway. Note, however, that objects in the foreground may not always be in focus.
- AF-assist illuminator (📖 136) does not light.





* Default setting can be modified.

Shooting Suited to Scenes (Scene Mode)

Sports

Use this mode for dynamic action shots that freeze the action in a single shot and record motion in a series of pictures.



- Camera focuses on the subject at the center of the frame and focuses continuously until focus is locked by pressing the shutter-release button halfway.
- While the shutter-release button is held down, up to three pictures are taken at a rate of about 0.9 frames per second (fps) when **Image mode** is set to  **4000x3000**.
- Focus, exposure and white balance are fixed at the values determined with the first picture in each series.
- AF-assist illuminator ( 136) does not light.
- The maximum frame rate with continuous shooting may vary depending upon the current image mode setting, the memory card used, or shooting condition.



* Default setting can be modified.

Night portrait

Use this mode for portraits taken at sunset or at night. The flash fires to light the portrait subject while preserving background lighting to achieve a natural balance between the main subject and background ambience.

- The camera recognizes and focuses on a human face. See "Face Priority" ( 46) for more information.
- If more than one face is recognized, focus will be on the face nearest to the camera.
- The camera softens skin tones (in up to three faces) by applying the skin softening function before recording pictures ( 63).
- If no faces are recognized, the camera focuses on the subject at the center of the screen.
- Digital zoom is not available.



¹ Fill flash with slow sync and red-eye reduction.

² Default setting can be modified.

Use of a tripod is recommended in scene modes with which  is indicated.

Party/indoor

Captures the effects of candlelight and other indoor background lighting.

- Camera focuses on the subject at the center of the frame.
- As pictures are easily affected by camera shake, hold the camera steadily. In dark surroundings, the use of a tripod is recommended.



¹ Slow sync with red-eye reduction flash mode may be used. The default setting can be modified.

² Default setting can be modified.

Beach/snow

Captures the brightness of such subjects as snowfields, beaches, or sunlit expanses of water.

- Camera focuses on the subject at the center of the frame.



* Default setting can be modified.

Sunset



Preserves the deep hues seen in sunsets and sunrises.

- Camera focuses on the subject at the center of the frame.



* Default setting can be modified.

Dusk/dawn



Preserves the colors seen in the weak natural light before sunrise or after sunset.

- Camera focuses at infinity. The focus area or focus indicator (6) always glows green when the shutter-release button is pressed halfway. Note, however, that objects in the foreground may not always be in focus.
- AF-assist illuminator (136) does not light.





* Default setting can be modified.

Shooting Suited to Scenes (Scene Mode)

Night landscape



Slow shutter speeds are used to produce stunning night landscapes.

- Camera focuses at infinity. The focus area or focus indicator ( 6) always glows green when the shutter-release button is pressed halfway. Note, however, that objects in the foreground may not always be in focus.
- AF-assist illuminator ( 136) does not light.







			Off*		Off		0.0*
---	---	---	------	---	-----	---	------









* Default setting can be modified.

Close-up

Photograph flowers, insects and other small objects at close range.

- Macro mode ( 33) is enabled and the camera automatically zooms to the closest position at which it can focus.
- The closest distance at which the camera can focus varies depending on the zoom position. The camera can focus at the shortest distances when  and the zoom indicator glow green with the zoom indicator positioned to the left (wider angle) of .

At the zoom position one step to the right (telephoto) of the maximum wide-angle zoom position, the camera can focus on subjects as close as 8 cm (3.2 in.) to the lens. At the maximum wide-angle zoom position and  zoom position, the camera can focus at a distance of 20 cm (8 in.).

- **AF area mode** is set to **Manual** ( 44). Choose the focus area in which the camera focuses.
Press the  button or press the multi selector , , , or , to select a different focus area. Press the  button again to lock the selected focus area. Flash mode and exposure compensation settings can be adjusted and the self-timer can be enabled while the focus area is locked. Press the  button to choose the focus area in which the camera focuses.
- The camera focuses continuously until focus is locked by pressing the shutter-release button halfway.
- As pictures are easily affected by camera shake, hold the camera steadily.





	 AUTO*		Off*		On		0.0*
---	---	---	------	---	----	---	------

* Default setting can be modified. Note that the flash may be unable to light entire subject at distances of less than 50 cm (1 ft. 8 in.).









Use of a tripod is recommended in scene modes with which  is indicated.

Food

This mode is useful when taking pictures of food.

- Macro mode (📖 33) is enabled and the camera automatically zooms to the closest position at which it can focus.
- The closest distance at which the camera can focus varies depending on the zoom position. The camera can focus at the shortest distances when  and the zoom indicator glow green with the zoom indicator positioned to the left (wider angle) of .

At the zoom position one step to the right (telephoto) of the maximum wide-angle zoom position, the camera can focus on subjects as close as 8 cm (3.2 in.) to the lens. At the maximum wide-angle zoom position and  zoom position, the camera can focus at a distance of 20 cm (8 in.).

- Hue can be adjusted in the range of the creative slider displayed at left in the monitor. Press the multi selector  to make the image more reddish, or  to make it more bluish. The selected hue adjustment setting is stored in the camera's memory even after the camera is turned off, and reapplied the next time food scene mode is selected.
- **AF area mode** is set to **Manual** (📖 44). Choose the focus area in which the camera focuses. Press the  button or press the multi selector , , , or , to select a different focus area. Press the  button again to lock the selected focus area. Hue adjustment and exposure compensation settings can be adjusted and the self-timer can be enabled while the focus area is locked.
- The camera focuses continuously until focus is locked by pressing the shutter-release button halfway.
- As pictures are easily affected by camera shake, hold the camera steadily.

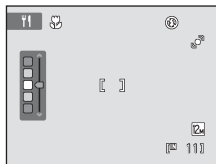

			Off*		On		0.0*
---	---	---	------	---	----	---	------

* Default setting can be modified.

Museum

Use indoors where flash photography is prohibited (for example, in museums and art galleries) or in other settings in which you do not want to use the flash.

- Camera focuses on subject at the center of the frame.
- BSS (best shot selector) can be enabled (📖 41).
- As pictures are easily affected by camera shake, hold the camera steadily.
- AF-assist illuminator (📖 136) does not light.



			Off*		Off*		0.0*
---	---	---	------	---	------	---	------

* Default setting can be modified.

Shooting Suited to Scenes (Scene Mode)

Fireworks show



Slow shutter speeds are used to capture the expanding burst of light from a firework.

- Camera focuses at infinity. The focus indicator (📖 6) always glows green when the shutter-release button is pressed halfway. Note, however, that objects in the foreground may not always be in focus.
- AF-assist illuminator (📖 136) does not light.



Copy

Provides clear pictures of text or drawings on a white board or in print.

- Camera focuses on subject at the center of the frame.
- Use macro mode (📖 33) to focus at short ranges.
- Colored text and drawings may not show up well.

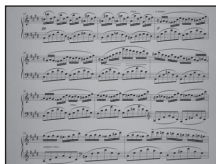

* Default setting can be modified.

Backlight

Use when light is coming from behind the subject, throwing features or details into shadow. The flash fires automatically to “fill in” (illuminate) shadows.

- Camera focuses on subject at the center of the frame.



* Default setting can be modified.

Panorama assist





Use when taking a series of pictures that will later be joined to form a single panorama using the supplied Panorama Maker software. See “Shooting for a Panorama” (📖 60) for details.



* Default setting can be modified.

Shooting for a Panorama





The camera focuses on the subject at the center of the frame. Use a tripod for the best results.



- 1 Press the  button in shooting mode to display the shooting-mode selection menu and use the multi selector to select  (**Panorama assist**) scene mode (📖 50).

Panorama direction icons are displayed to show the direction in which pictures will be joined.



- 2 Use the multi selector to choose the direction and press the  button.

Select the direction in which pictures will be joined in the completed panorama; right () , left () , up () or down () .

The yellow panorama direction icon () is displayed for the current direction and the direction is fixed when  is pressed. The icon changes to the white fixed direction  icon.

If necessary, apply flash mode (📖 30), self-timer (📖 32), macro mode (📖 33) and exposure compensation (📖 34) settings with this step. Press the  button again to choose a different direction.



- 3 Frame the first portion of the panorama scene and take the first picture.

One third of the picture will be displayed as translucent.



- 4 Take the next picture.

Frame the next picture so that one third of the frame overlaps the first picture, and press the shutter-release button.

Repeat this process until the necessary number of pictures has been taken to complete the scene.



5 Press the **OK** button when shooting is complete.

The camera returns to step 2.



✓ Notes on Panorama Assist

- Flash mode, self-timer, macro mode and exposure compensation settings cannot be adjusted after the first picture is taken. Pictures cannot be deleted, nor can zoom or **Image mode** setting (📖 37) be adjusted after the first picture has been taken.
- Shooting for the panorama series is terminated if the auto off function (📖 137) initiates standby mode during shooting. Setting the time allowed to elapse before the auto off function is enabled to a longer setting is recommended.

🔍 AE/AF-L Indicator

In **Panorama assist** scene mode, exposure, white balance, and focus for all pictures in a panorama are fixed at the values for the first picture in each series.

When the first picture is taken, **AE/AF-L** is displayed to indicate that exposure, white balance, and focus are locked.



🔍 Panorama Maker

Install Panorama Maker from the supplied Software Suite CD.





Transfer pictures to a computer (📖 112) and use Panorama Maker (📖 116) to join them in a single panorama.

🔍 More Information

See "Image/Sound File and Folder Names" (📖 151) for more information.

Shooting Smiling Faces (Smart Portrait Mode)

At the default settings, the camera uses face priority to recognize human faces, and then automatically releases the shutter when a smile is detected (smile timer). The skin softening option can be used to smooth skin tones of human faces.

- 1 Press the  button in shooting mode to display shooting mode menu, press the multi selector  or  to select , and press the  button.

The camera enters smart portrait mode.

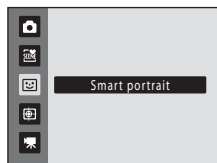

- 2 Frame a picture.

Point the camera at the subject.

When the camera recognizes a human face, a yellow double border (focus area) is displayed around that face. When focus is acquired on that face, the double border will turn green for a moment and focus is locked.

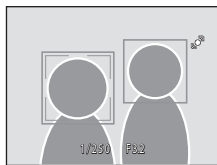

Up to three faces can be recognized. When the camera detects more than one face, the double border is displayed around the face closest to the center of the frame, and single borders around the others.

- 3 The shutter is automatically released.

If the camera detects that the face framed by the double border is smiling, **Smile timer** ( 64) is activated and the shutter is automatically released.

When the camera recognizes a face, the self-timer lamp ( 4) blinks. Immediately after the shutter is released, the self-timer lamp flickers.

Each time the shutter is released, the camera again initiates face recognition and smile detection operations for continuous automatic shooting.

Pictures can also be taken by pressing the shutter release button. The camera can focus on the subject at the center of the frame when faces are not recognized.

When the shutter is released, the camera softens the subject's skin to make it appear smoother and then records the image (**Skin softening**;  64).

- 4 Shooting ends.

To stop automatic shooting of smiling faces, either turn the camera off, set **Smile timer** to **Off**, or press the  button and select another shooting mode.

✔ Notes on Smart Portrait Mode

- Digital zoom is not available.
- Under some shooting conditions, the camera may be unable to recognize faces or detect smiles.
- See “Notes on Face Priority” (📖 47) for more information.

✔ Notes on Skin Softening

- More time than usual may be required to save a picture when shooting with skin softening function.
- In some shooting conditions, facial skin tones may not be smoothed or parts other than face may be modified though the camera recognizes a face. If the desired results are not produced, set **Skin softening** to **Off** and shoot again.
- The skin softening level cannot be adjusted when the portrait or night portrait is selected in the scene mode.
- Skin softening can also be applied on recorded pictures (📖 102).

🔪 Auto Power Off in Smile Timer Mode

When **Smile timer** is set to **On**, the auto power off function (📖 137) is activated and the camera turns off when either of the situations indicated below persists and no other operations are performed.

- The camera does not recognize any faces.
- The camera recognized a face, but cannot detect a smile.

🔪 Functions Available in Smart Portrait Mode

- Flash cannot be used when **Blink proof** is set to **On**. When **Blink proof** is set to **Off**, flash mode (📖 30) is set to **⚡AUTO** (auto) (can be modified).
- The self timer (📖 32) options can be applied when **Smile timer** is set to **Off**.
- Macro mode (📖 33) cannot be used.
- Exposure compensation (📖 34) is enabled.
- When pressing the **MENU** button to display 📷 (smart portrait) menu, **Image mode**, **Skin softening**, **Smile timer**, or **Blink proof** options can be applied (📖 64).

🔪 More Information

See “Autofocus” (📖 27) for more information.

Smart Portrait Menu

The following options can be applied in the smart portrait menu.

Press the **MENU** button (📖 10) in smart portrait mode (📖 62) to display the smart portrait menu and use the multi selector (📖 9) to apply options.



Image mode

Adjust **Image mode** (📖 37).

Changes made to the image mode setting are reflected in all shooting modes (except movie mode).



Skin softening

Enable skin softening. When the shutter is released, the camera detects one or more human faces (up to three), and processes the image to soften facial skin tones before saving the picture.

The degree of skin softening applied can be selected from **High**, **Normal** (default setting), and **Low**. When **Off** is selected, the skin softening function is disabled.

- The current setting can be confirmed by the indicator displayed in the monitor with shooting (📖 6). No indicator is displayed when **Off** is selected. The effects of skin softening are not visible when framing pictures for shooting. Check the degree of skin softening performed in playback mode.



Smile timer

- **On** (default setting): The camera uses face priority to recognize a human face, and then automatically releases the shutter whenever a smile is detected.
- **Off**: The camera does not release the shutter automatically with smile detection. Press the shutter-release button to take a picture.
- When smile timer is enabled, an indicator is displayed in the monitor with shooting (📖 6). No indicator is displayed when **Off** is selected



Blink proof





When **On** is selected, the camera automatically releases the shutter twice each time a picture is taken. Of the two shots, one in which the subject's eyes are open is saved.

- If the camera saved a picture in which the subject's eyes may have been closed, the dialog shown at right is displayed for a few seconds.
- Flash cannot be used when **On** is selected.
- The default setting is **Off**.
- The current setting is displayed in the monitor (📖 6). No indicator is displayed when **Off** is selected.



Focusing on a Moving Subject (Subject Tracking Mode)

Use this mode to take pictures of moving subjects. Select the subject which the camera will focus. The focus area will automatically move to track the subject.

- 1** Press the  button in shooting mode to display the shooting mode menu, press the multi-selector  or  to select , and press the  button.

The display switches to that for subject tracking mode and a white border is displayed at the center of the frame.

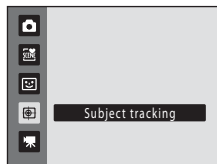

- 2** Select a subject.

Align the subject with the border at the center of the frame and press the  button.

- The subject is selected.
- When the camera is unable to focus on the subject, the border will glow red. Change the composition and try again.

When the subject is selected, a yellow border (focus area) is displayed around that subject and the camera begins tracking that subject.

To change the subject, press the  button to deselect the current subject.

If the selected subject is not visible in the monitor, the focus area indicator will disappear and the selection will be canceled. Select the subject again.

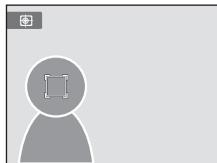
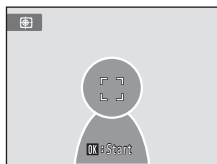

- 3** Press the shutter-release button to take a picture.

The camera focuses on the focus area when the shutter-release button is pressed halfway. The focus area indicator will glow green and focus will be locked.

When the camera is unable to focus, the focus area indicator will blink. Press the shutter-release button halfway again to focus.



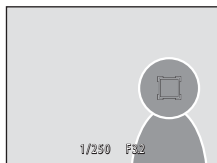

If the shutter-release button is pressed halfway while the focus area indicator is not displayed, the camera focuses on the subject at the center of the frame.

Press the shutter-release button all the way down to release the shutter.









Focusing on a Moving Subject (Subject Tracking Mode)

Notes on Subject Tracking Mode

- Digital zoom is not available.
- Adjust zoom position, exposure, menu settings, and flash mode prior to selecting the subject. If any camera setting is changed after the subject has been selected, subject selection will be canceled.
- It may be impossible to select the desired subject, or the camera may be unable to track the selected subject or may begin tracking a different subject, if the subject is moving rapidly, if there is a significant amount of camera shake, or if the camera recognizes a similar subject. The camera's ability to accurately track the selected subject is also dependent upon the size and brightness of the subject.
- In some rare cases, subjects with which autofocus may not perform as expected ( 27) may be out of focus despite the fact that the focus area indicator glows green. Should this occur, switch to  (auto) mode and set **AF area mode** ( 44) to **Manual** or **Center**, refocus on another subject positioned at the same distance from the camera as the actual portrait subject, and use focus lock ( 45).

Functions Available in Subject Tracking Mode

- Flash mode ( 30) and exposure compensation ( 34) settings can be adjusted.
- Self-timer ( 32) and macro mode ( 33) cannot be used.
- Press the **MENU** button to display the  (subject tracking) menu and adjust **Image mode** and **Autofocus mode** ( 67).

Shooting in Subject Tracking Menu

The following options can be applied in the subject tracking menu.

Press the **MENU** button (📖 10) in subject tracking mode (📖 65) to display the subject tracking menu and use the multi selector (📖 9) to modify and apply settings.

🔙 Image mode

Allows you to set **Image mode** (📖 37).

Changes made to the image mode setting apply to all shooting modes (except movie recording).



🔊 Autofocus mode

Allows you to set the **Autofocus mode** (📖 48) used for subject tracking mode (the default setting is **Full-time AF**).

When using subject tracking mode while set to **Full-time AF**, the camera continuously focuses once a subject is selected for subject tracking until the shutter-release button is pressed halfway to lock the focus. The sound of the camera focusing will be heard.







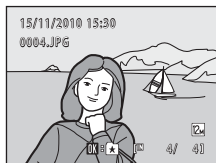













Changes made to the autofocus mode setting in this mode will not be applied to the autofocus mode setting in the 📷 (auto) mode. The autofocus mode setting applied in the subject tracking mode is stored in the camera's memory even after the camera is turned off.

Operations in Full-frame Playback Mode



Press the  button in shooting mode to enter playback mode and pictures taken are displayed ( 28).



The following operations are available in full-frame playback mode.

To	Use	Description	
Select pictures		Press  ,  ,  , or  to display previous or subsequent pictures. Press and hold  ,  ,  , or  to scroll quickly through pictures.	9
View thumbnails/ enable calendar display	W 	Display 4, 9, or 16 picture thumbnails. Rotate the zoom control to W  in the 16-picture thumbnail display to apply the calendar display.	69, 71
Select a different shooting date (list by date mode)	W 	Return to the list by date screen.	83
Playback zoom	T 	Enlarge the view of the picture currently displayed in the monitor, up to about 10x. Press the OK button to return to full-frame playback mode.	72
Add to/remove from album	OK	Press the OK button to add current picture to an album (in playback mode, auto sort mode or list by date mode). Press the OK button in favorite pictures mode to remove the current picture from an album.	74, 76
Play back movies	OK	Play back the movie currently displayed.	110
Delete picture		Delete the picture currently displayed to albums.	28
Display menus	MENU	Display the menu for the selected mode.	86
Switch to playback mode		Press the  button to display the playback-mode selection menu and switch to favorite pictures mode, auto sort mode, or list by date mode.	73
Switch to shooting mode		Press  button or shutter-release button.	28
			

Viewing Pictures

When pictures in which a face was recognized during shooting ( 46) are displayed in full-frame playback mode, the pictures may be automatically rotated for playback display according to the orientation of the recognized face. Pictures taken at a **Continuous** setting ( 41) of **Continuous**, **BSS**, or **Multi-shot 16** will be rotated.

Viewing Multiple Pictures: Thumbnail Playback

Rotate the zoom control to **W** (📐) in full-frame playback mode (📖 28) to display pictures in “contact sheets” of thumbnail images (except in list by date mode).



The following operations are available while thumbnails are displayed.

To	Use	Description	📖
Choose pictures		Press the multi selector ▲, ▼, ◀, or ▶.	9
Increase the number of pictures displayed/apply the calendar display	W (📐)	Rotate the zoom control to W (📐) to increase the number of picture thumbnails displayed: 4 → 9 → 16. Rotate the zoom control to W (📐) in the 16-picture thumbnail display to apply the calendar display (📖 71), and pictures can be found by the date on which they were taken. Rotate the zoom control to T (📷) to return to thumbnail display.	–
Decrease the number of pictures displayed	T (📷)	Rotate the zoom control to T (📷) to decrease the number of picture thumbnails displayed: 16 → 9 → 4. Rotate the zoom control to T (📷) in 4-picture thumbnail display to return to full-frame playback mode.	–
Cancel thumbnail playback		Press the button.	28
Switch to shooting mode		Press the button or the shutter-release button to return to the last shooting mode selected.	28

Viewing Multiple Pictures: Thumbnail Playback

Thumbnail Playback Mode Display

When pictures marked using **Print set** (📖 87) or **Protect** (📖 94) are selected, the icons shown at right are displayed with them.

Movies are displayed as film frames.

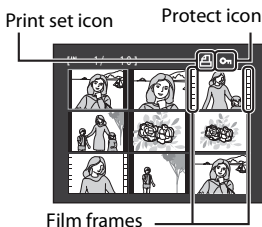

Thumbnail Display in Favorite Pictures and Auto Sort Mode

- When thumbnails are displayed in favorite pictures mode (📖 74), the favorite pictures icon is displayed at right above the thumbnails.
- When thumbnails are displayed in auto sort mode (📖 80), the category icon of the pictures is displayed at right above the thumbnails.

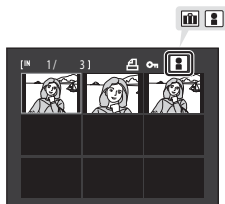

Calendar Display

With playback display of 16 thumbnails (📖 69), rotate the zoom control to **W** (📷) to switch to calendar display.

Images can be selected for display based on the date on which they were taken. The dates on which pictures were taken are underlined in yellow.

The following operations are available in calendar display.

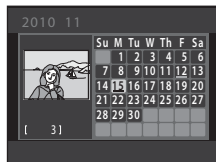

To	Use	Description	📖
Select date		Press the multi selector ▲, ▼, ◀, or ▶.	9
Return to full-frame playback		The first picture taken on the selected date is displayed full frame.	28
Return to thumbnail display	T (📷)	Rotate the zoom control to T (📷).	69

✓ Notes on Calendar Display

- Pictures taken when the camera's date is not set are treated as pictures taken on January 1, 2010.
- The 🗑️ button and MENU button are not available in calendar display.

🔍 List by Date Mode

Only the pictures taken on the same date can be played back in list by date mode (📖 83). The list by date options (📖 85) are also available only for the pictures taken on the selected dates.

Taking a Closer Look: Playback Zoom

Rotating the zoom control to **T** (Q) in full-frame playback mode (📖 28) enlarges display of the center portion of the current picture.

- The guide displayed at bottom right shows the portion of the image currently displayed.

The following operations can be performed while picture display is enlarged.



To	Use	Description	📖
Zoom in	T (Q)	Zoom increases each time the zoom control is rotated to T (Q), to a maximum of 10x.	–
Zoom out	W (E)	Zoom decreases each time the zoom control is rotated to W (E). When the magnification ratio reaches 1x, the display returns to full-frame playback mode.	–
View other areas of picture		Press the multi selector ▲, ▼, ◀, or ▶ to move the display area to other areas of the picture.	9
Switch to full-frame playback	OK	Press the OK button.	28
Crop picture	MENU	Press the MENU button to crop current picture to contain only the portion visible in the monitor.	105
Switch to shooting mode		Press the button or the shutter-release button.	28

More on Playback





Pictures Taken with Face Priority

When zooming in (playback zoom) on a picture taken using the face-priority function (📖 46) by rotating the zoom control to **T** (Q) in full-frame playback mode, the picture will be enlarged with the face recognized with shooting at the center of the monitor (except pictures taken with **Continuous**, **BSS** and **Multi-shot 16**; 📖 41).

- If more than one face was recognized, the picture will be enlarged with the face on which focus was acquired at the center of the monitor. Press the multi selector ▲, ▼, ◀, or ▶ to display other recognized faces.
- When the zoom control is rotated to **T** (Q) or **W** (E) to adjust the zoom ratio, the center of the picture (normal playback zoom display), rather than the face, is displayed at the center of the monitor.



Selecting a Playback Mode

Select a playback mode from  (playback),  (favorite picture),  (auto sort), and  (list by date) modes.

1 Press the button in playback mode.

The playback-mode selection menu is displayed.

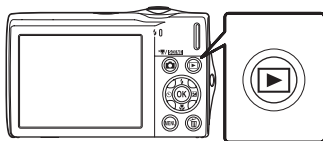









2 Use the multi selector or to select a playback mode and press the button.

The camera enters the selected playback mode.

To return to the current playback mode without switching playback modes, press the  button.



More on Playback

- | | | |
|---|--|--|
| 1 |  Playback mode |  28 |
| | Play back all pictures. | |
| 2 |  Favorite picture mode |  74 |
| | Play back pictures added to an album. | |
| 3 |  Auto sort mode |  80 |
| | Play back pictures and movies automatically sorted to the selected category with shooting. | |
| 4 |  List by date mode |  83 |
| | Play back pictures taken on the selected date. | |

Sorting Favorite Pictures (Favorite Pictures Mode)

Pictures can be sorted to albums. Once pictures have been added to albums, favorite pictures mode can be used to play back only the pictures in a specific album. Adding pictures to albums makes finding a particular picture faster and easier.

Pictures can be sorted to albums categorized by themes such as travel or weddings.

The same picture can be added to multiple albums.

Adding Pictures to Albums

Pictures can be sorted by adding them to albums.

1 Display pictures in playback mode (📖 28), auto sort mode (📖 80), or list by date mode (📖 83).

2 Select a favorite picture and press the **OK** button.

Select full-frame playback mode and press the **OK** button.

The albums selection screen is displayed.

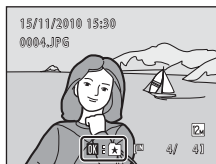

3 Use the multi selector to choose a desired album and press the **OK** button.

After pictures have been added, monitor display returns to full-frame playback mode.

To add the same picture to multiple albums, repeat the procedure from step 1 or 2.

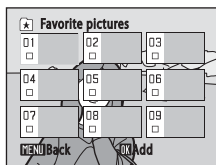

✓ Notes on Adding Favorite Pictures

- An album can contain up to 200 pictures.
- Movies cannot be added to albums.
- If the selected picture has already been added to an album, the checkbox for the folder to which it has been added will be checked (✓).
- When pictures are added to albums, they are not physically copied to albums or moved from the folder (📖 151) to which they were originally recorded (📖 79).





📖 More information

See "Removing Pictures from Albums" (📖 76) for more information.

Viewing Pictures in an Album





Pictures can be displayed by selecting the album to which they were added in “★ favorite pictures mode”.

- In full-frame playback mode, just as with normal playback mode, picture display can be enlarged and pictures can be displayed as thumbnails or in calendar mode. Still pictures can be edited and movies can be played back.
- When the **MENU** button is pressed in the full-frame or thumbnail playback mode to display the favorite pictures menu (77), all pictures sorted to the specified album can be selected for deletion, viewing in a slide show, printing, or protection.

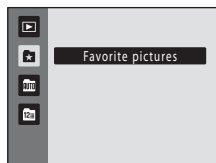
- 1 Press the  button in playback mode to display the playback-mode selection menu, press the multi selector  or  to choose , and press the  button.

A list of albums is displayed.



- 2 Press the multi selector , , , or  to select the desired album.

Press the  button to display a picture in the selected album in full-frame playback mode.

The icon for the current album is displayed at the top right of the screen.

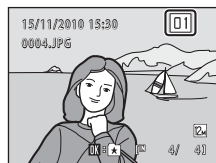
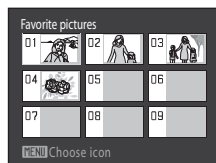

Removing Pictures from Albums

To remove a picture from an album without permanently deleting it, follow the procedures described below.

- Select the desired picture in full-frame display in step 2 in favorite pictures mode (📖 75), and press the **OK** button to display the confirmation dialog.
- To remove the picture from the album, choose **Yes** and press the **OK** button. To continue without removing the picture, choose **No** and press the **OK** button.

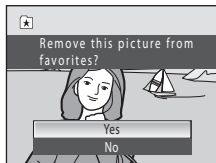













✔ Note on Deleting Pictures in Favorite Pictures Mode

Note that deleting a picture in favorite pictures mode deletes not only the picture from the album, but also deletes the original picture from the internal memory or memory card permanently (📖 79).

Using Favorite Pictures Mode

The following operations are available with display of album list.

To	Use	Description	
Select album		Press the multi selector ▲, ▼, ◀, or ▶.	9
Switch to full-frame playback		Press the  button to display the first picture in the album.	68
Delete picture		Press the  button after selecting an album, and a confirmation dialog will be displayed. Choose Yes and press the  button to delete all pictures sorted to that album.	28
Change album icon	MENU	Change the icon assigned to an album.	78
Switch to another playback mode		Press the  button to display the playback-mode selection menu.	73
Switch to shooting mode		Press the  button or the shutter-release button.	28
			





Favorite Pictures Menu

Press the **MENU** button in full-frame playback mode or thumbnail playback mode in favorite pictures mode to apply the following menu options.

Quick retouch	→  100
D-Lighting	→  101
Skin softening	→  102
Print set	→  87
Slide show	→  91
Delete	→  92
Protect	→  94
Rotate image	→  94
Small picture	→  104
Voice memo	→  95





Changing Icons Assigned to Albums

The icon assigned to the album can be changed to reflect the theme of pictures included in the album.

- 1 Press the  button in playback mode to display the playback-mode selection menu and press the multi selector  or  to choose , and then press the .



A list of albums is displayed.





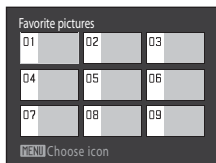

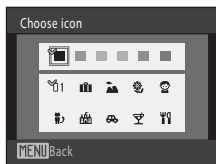

- 2 Press the multi selector , , , or  to select the desired album and press the **MENU** button.

The icon selection screen is displayed.



- 3 Use the multi selector  or  to choose an icon color and press the .



- 4 Use the multi selector , , , or  to choose an icon and press the .

The icon is modified and monitor display returns to the list of albums.

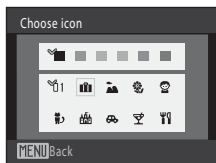

Notes on Icons for Albums

Choose icons for albums separately for the internal memory and for every memory card used.

- To change the icon for an album containing pictures stored in the internal memory, remove the memory card from the camera.
- The default setting for icons are black numbers.

Adding/Viewing Favorite Pictures

When pictures are added to albums, they are not physically copied to albums or moved from the folder to which they were originally recorded (📖 151). Only the file names of pictures are added to albums. In favorite pictures mode, pictures with file names that have been added to the specified album are played back. Note that deleting a picture (📖 28, 77, 92) played back in favorite pictures mode deletes not only the picture from the album, but also deletes the original picture from the internal memory or memory card permanently.

Adding Pictures to Albums

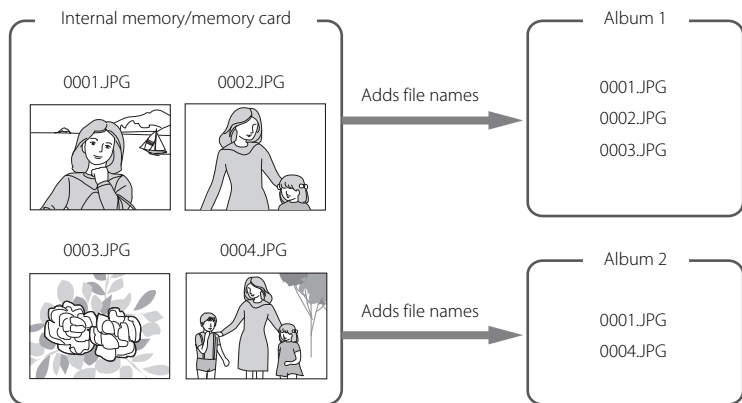





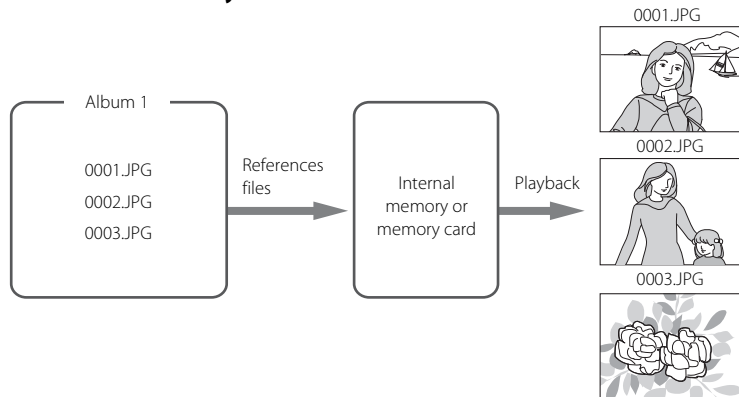



More on Playback

Favorite Pictures Playback







Finding Pictures in Auto Sort Mode

Pictures and movies are automatically sorted to any of the following categories with shooting. When “ auto sort mode” is selected, pictures and movies can be viewed by selecting the category to which they were sorted.

 Smile	 Portraits	 Food
 Landscape	 Dusk to dawn	 Close-ups
 Movie	 Retouched copies	 Other scenes



- In full-frame playback mode, just as with normal playback mode, picture display can be enlarged and pictures can be displayed as thumbnails or in calendar mode.
- Still pictures can be edited and added to albums, and movies can be played back.
- When the **MENU** button is pressed, the auto sort menu ( 82) is displayed and all pictures sorted to the specified category can be selected for deletion, viewing in a slide show, or applying print order or protection setting.

Displaying Pictures in Auto Sort Mode

- 1 Press the  button in playback mode to display the playback-mode selection menu and press the multi selector  or  to choose , and then press the **OK** button.

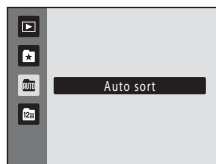
A list of categories is displayed.



- 2 Press the multi selector , , , or  to select a desired category.

For details of categories, see “Categories and the Contents” ( 81).

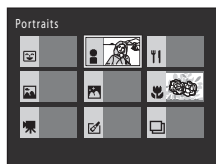







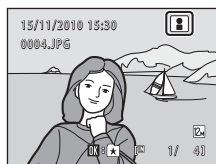



Press the **OK** button to display a picture in the selected category in full-frame playback mode.

The icon of the category currently played back will be displayed at the top right of the screen.

Select an image and press the **OK** button to sort the image to the album ( 74).



Categories and the Contents

Folder name	Description
 Smile	Pictures taken in smart portrait mode (📖 62) with the smile timer setting set to On are displayed.
 Portraits	Pictures taken in  (auto) mode (📖 22) with the face priority and those taken in Portrait* , Night portrait* , Party/indoor , and Backlight* scene mode (📖 50) are displayed. Pictures taken in smart portrait mode (📖 62) with the smile timer setting set to Off are displayed.
 Food	Pictures taken in Food scene mode (📖 50) are displayed.
 Landscape	Pictures taken in Landscape* scene mode (📖 50) are displayed.
 Dusk to dawn	Pictures taken in Night landscape* , Sunset , Dusk/dawn and Fireworks show scene mode (📖 50) are displayed.
 Close-ups	Pictures taken in Close-up* scene mode (📖 50) and those taken in  (auto) mode with macro mode (📖 33) are displayed.
 Movie	Movies (📖 106) are displayed.
 Retouched copies	Copies created using editing function (📖 98) are displayed.
 Other scenes	All other pictures that cannot be defined by the categories described above are displayed.







* Pictures taken in scene auto selector scene mode (📖 51) are also sorted to the appropriate categories.

Notes on Auto Sort Mode

- Up to 999 pictures and movie files can be sorted to each category in auto sort mode. If 999 pictures or movies have already been sorted to a specific category, new pictures and movies cannot be sorted to that category or displayed in auto sort mode. Display pictures and movies that could not be sorted to a category in normal playback mode (📖 28) or list by date mode (📖 83).
- Pictures or movies copied from the internal memory to a memory card, or vice versa (📖 97), cannot be displayed in auto sort mode.
- Pictures or movies recorded by a camera other than the COOLPIX S205 cannot be displayed in auto sort mode.

Using Auto Sort Mode











The following operations are available in the category list screen.

To	Use	Description	
Select the folder name		Press the multi selector ▲, ▼, ◀, or ▶ to select the folder.	9
Switch to full-frame playback		Press the OK button to display the first picture in the selected folder.	68
Delete picture		Press the trash button after selecting a category, and a confirmation dialog will be displayed. Choose Yes and press the OK button to delete all pictures sorted to that category.	28
Switch to another playback mode		Press the playback mode button to display the playback-mode selection menu.	73
Switch to shooting mode		Press the camera button or the shutter-release button.	28
			

More on Playback

Auto Sort Menu

Press the **MENU** button in full-frame playback mode or thumbnail playback mode in auto sort mode to apply the following menu options.





Quick retouch	→  100
D-Lighting	→  101
Skin softening	→  102
Print set	→  87
Slide show	→  91
Delete	→  92
Protect	→  94
Rotate image	→  94
Small picture	→  104
Voice memo	→  95

Viewing Pictures by Date (List by Date)

In “ list by date mode”, pictures taken on the same date can be played back.

- In full-frame playback mode, just as with normal playback mode, picture display can be enlarged, pictures can be edited or added to albums, and movies can be played back.
- When the **MENU** button is pressed, the list by date menu ( 85) is displayed and all pictures taken on a specified date can be selected for deletion, viewing in a slide show, or applying print order or protection setting.

Selecting a Date in List by Date Mode

- 1 Press the  button in playback mode to display the playback-mode selection menu and press the multi selector  or  to choose , and then press the  button.





Dates for which pictures exist are listed.



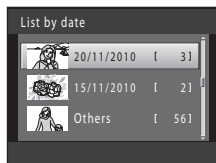

- 2 Press the multi selector  or  to select the desired date.

Camera lists up to 29 dates. If pictures exist for more than 29 dates, all pictures recorded earlier than most recent 29 dates will be combined under **Others**.



Press the  button to display the first picture taken on the selected date.

Select an image and press the  button to sort the image to the album ( 74).

Rotate the zoom control to **W** () in full-frame playback mode to return to the list by date screen.

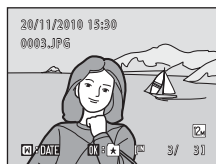















Notes on List by Date Mode

- Up to 9,000 of the most recently recorded pictures can be displayed in list by date mode. If more pictures exist, “**” is displayed next to the number of pictures for the date containing the 9,001st most recent picture.
- Pictures taken when the camera’s date is not set are treated as pictures taken on January 1, 2010.











Using List by Date Mode

The following operations are available in the list by date screen.

To	Use	Description	
Select date		Press the multi selector ▲ or ▼ to select a date.	9
Switch to full-frame playback		Press the  button to display the first picture taken on the selected date. Rotate the zoom control to W  in full-frame playback mode to return to the list by date screen.	68
Delete picture		Press the  button to delete after selecting a date, and a confirmation dialog will be displayed. Choose Yes and press the  button to delete all pictures taken on the date.	28
View list by date menu	MENU	Press the MENU button to display the list by date menu.	85
Switch to another playback mode		Press the  button to display the playback-mode selection menu.	73
Switch to shooting mode		Press the  button or the shutter-release button.	28
	 		

List by Date Menu

Press the **MENU** button in list by date mode to display the following menus for only the pictures taken on the specified date.

Quick retouch*	→		100
D-Lighting*	→		101
Skin softening*	→		102
Print set	→		87
Slide show	→		91
Delete	→		92
Protect	→		94
Rotate image*	→		94
Small picture*	→		104
Voice memo*	→		95

* During full-frame playback only

When the **MENU** button is pressed in the list by date screen ( 83), options can be applied to all pictures taken on the same date, or all pictures taken on the same date can be deleted. To apply options to individual pictures, or to select individual pictures for deletion, display a picture full-frame and press the **MENU** button.

Playback Option: Playback Menu

The following options are available in the playback menu.

	Quick retouch 📖 100
Easily create retouched copies in which contrast and saturation have been enhanced.	
	D-Lighting 📖 101
Enhances brightness and contrast in dark portions of pictures.	
	Skin softening 📖 102
The camera detects faces and creates a copy of the picture with softer skin tones in the faces of portrait subjects.	
	Print set 📖 87
Select pictures to print and the number of copies for each.	
	Slide show 📖 91
View pictures stored in the internal memory or on a memory card in an automatic slide show.	
	Delete 📖 92
Delete all or selected pictures.	
	Protect 📖 94
Protect selected pictures from accidental deletion.	
	Rotate image 📖 94
Change the orientation of pictures.	
	Small picture 📖 104
Create a small copy of the current picture.	
	Voice memo 📖 95
Record voice memos for pictures.	
	Copy 📖 97
Copy files between memory card and internal memory.	

More on Playback

Displaying the Playback Menu

Press the  button to enter playback mode (📖 28).

Press the **MENU** button to display the playback menu.

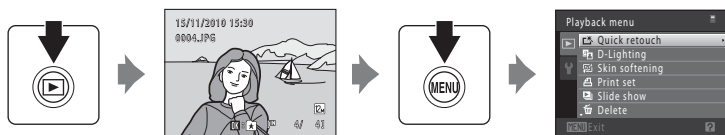

- Use the multi-selector to choose and apply settings (📖 9).
- Press the **MENU** button to exit the playback menu.

Print Set (Creating a DPOF Print Order)

▶ button (Playback mode) → MENU (Playback menu) → Print set

When printing pictures stored on the memory card using any of the following methods, the **Print set** option in the playback menu is used to create digital “print orders” for printing on DPOF-compatible devices.

- Inserting the memory card into a DPOF-compatible (📖 166) printer’s card slot
- Taking the memory card to a digital photo lab
- Connecting the camera to a PictBridge-compatible (📖 166) printer (📖 119). A print order can also be created for pictures stored in the internal memory if the memory card is removed from the camera.

1 Press the MENU button in playback mode.

The playback menu is displayed.



2 Use the multi selector to choose Print set and press the OK button.

Proceed to step 4 when playing back in favorite pictures mode, auto sort mode, or list by date mode.

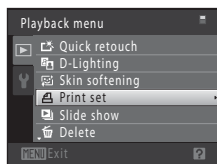

3 Choose Select images and press the OK button.

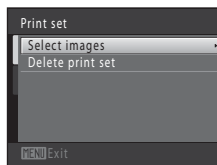

4 Choose pictures (up to 99) and the number of copies (up to nine) of each.

Press the multi selector ◀ or ▶ to select pictures, and press ▲ or ▼ to specify the number of copies to be printed.

Picture selected for printing can be recognized by the check mark (✔) icon and the numeral indicating the number of copies to be printed. If no copies have been specified for pictures, the selection is canceled.

Rotate the zoom control to **T** (🔍) to switch to full-frame playback.

Rotate the zoom control to **W** (🖼️) to switch back to 12-thumbnail display.

Press the **OK** button when setting is complete.

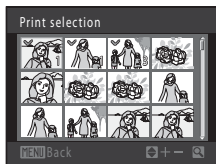

5 Choose whether or not to print shooting date and photo information.

Choose **Date** and press the **OK** button to print the shooting date on all pictures in the print order.

Choose **Info** and press the **OK** button to print shutter speed and aperture information on all pictures in the print order.

Choose **Done** and press the **OK** button to complete the print order and exit.

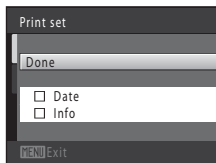

Pictures selected for printing are recognized by the 🖨️ icon displayed with playback.

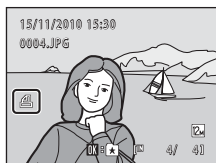

✓ Notes on Print Set

When a print order is created in favorite pictures mode, auto sort mode or list by date mode, the screen shown below is displayed if pictures other than those in the album, the selected category, or taken on the selected shooting date, have been marked for printing.

- Select **Yes** to add pictures in the selected album or category, or taken on the selected shooting date, to the existing print order.
- Select **No** to remove print marking from previously marked pictures and restrict the print order to pictures in the selected album or category, or taken on the selected shooting date.

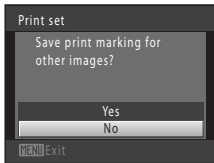

Favorite pictures mode/
auto sort mode

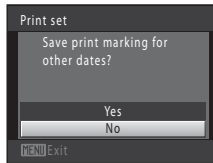

List by date mode

If the total number of the pictures in a print order exceeds 99, the screen shown below will be displayed.

- Select **Yes** to remove pictures previously added from the print order and restrict the print order to pictures just marked.
- Select **Cancel** to remove the pictures just added from the print order and restrict the print order to pictures previously marked.

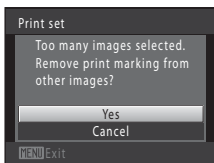

Favorite pictures mode/
auto sort mode

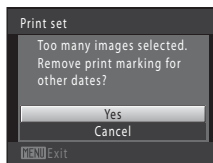

List by date mode

✔ Notes on Printing Shooting Date and Photo Information

When the **Date** and **Info** options are enabled in the print set option, shooting date and photo information are printed on pictures when a DPOF-compatible (📖 166) printer which supports printing of shooting date and photo information is used.

- Photo information cannot be printed when the camera is connected directly to a printer, via the supplied USB cable, for DPOF printing (📖 124).
- Note that **Date** and **Info** settings are reset when the print set option is displayed.
- The date printed is that recorded when the picture was taken. Changing the camera's date using the **Date** option in the setup menu after a picture has been taken has no affect on the date printed on the picture.



✏ Canceling Existing Print Order

Select **Delete print set** in step 3 of "Print Set (Creating a DPOF Print Order)" (📖 87) and press the **OK** button to remove print marking from all pictures and cancel the print order.

🕒 Date Imprint

When date and time of recording are imprinted on pictures using the **Date imprint** option (📖 133) in setup menu, pictures are recorded with shooting date and time imprinted on the picture when they are taken. Pictures with the date imprinted on them can be printed from printers that do not support printing of the date on pictures.

Only the date and time imprinted on pictures with the date imprint option will be printed, even if the **Print set** date option is enabled.



Slide Show

 button (Playback mode) → MENU (Playback menu) →  Slide show

Play back pictures stored in the internal memory or on a memory card one by one in an automated “slide show.”

1 Use the multi selector to choose **Start** and press the button.

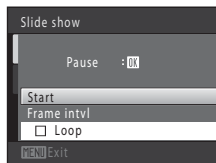

To change the interval between pictures, choose **Frame intvl**, select the desired interval time, and press the  button before choosing **Start**.

To repeat the slide show automatically, choose **Loop** and press the  button before choosing **Start**. The check mark () will be added to the loop option when enabled.



2 The slide show begins.

While the slide show is in progress, the following operations are available:

Press the multi selector  to display the subsequent picture or  to display the previous picture. Hold down either button to fast forward or rewind.

Press the  button to pause the slide show.



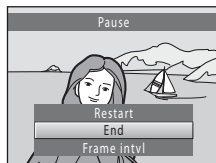

3 End the slide show or restart it.

When the slide show ends or is paused, choose **End** and press the  button to return to the playback menu, or choose **Restart** to play the slide show again.



Notes on Slide Show

- Only the first frame of movies ( 110) included in a slide show is displayed.
- The maximum playback time is up to 30 minutes even if **Loop** is enabled ( 137).

Delete (Deleting Multiple Pictures)

 button (Playback mode) → MENU (Playback menu) →  Delete

Delete selected pictures or all pictures.



Erase selected images

Select pictures from the picture selection screen and delete them. See “Selecting Pictures” ( 93) for more information.

Erase all images

Delete all pictures. In favorite pictures, auto sort, and list by date mode, all pictures in the album or auto sort category currently displayed, or taken on the selected date, are deleted. Albums and auto sort categories themselves are not deleted.

Notes on Deletion

- Once deleted, pictures cannot be recovered. Transfer important images to a computer before deletion.
- Pictures marked with the  icon are protected and cannot be deleted ( 94).

Selecting Pictures

The picture selection screen like that shown at right is displayed with the following menu selections:

- **Playback menu: Print set>Select images** (📖 87), **Delete>Erase selected images** (📖 92), **Protect** (📖 94), **Rotate image** (📖 94), and **Copy>Selected images** (📖 97)
- **Setup menu: Welcome screen>Select an image** (📖 128)

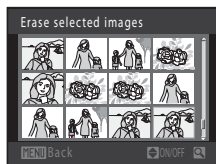

Follow the procedures described below to choose the pictures.

- 1 Press the multi selector ◀ or ▶ to choose the desired picture.

Only one picture can be selected at a time for **Rotate image** and **Welcome screen**. Proceed to step 3.

Rotate the zoom control to **T** (🔍) to switch to full-frame playback or **W** (📺) to switch back to 12-thumbnail display.



- 2 Press ▲ or ▼ to select or deselect (or to specify the number of copies).

When a picture is selected, a check mark (✔) is displayed with the picture. Repeat steps 1 and 2 to select additional pictures.

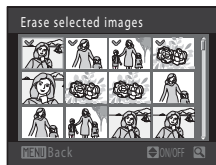

- 3 Press the (OK) button to finalize selection.

When **Erase selected images** is selected, a confirmation dialog is displayed. Follow the instructions displayed in the monitor.

Protect

▶ button (Playback mode) → MENU (Playback menu) → Protect

Protect selected pictures from accidental deletion.

Select pictures to protect or cancel protection for previously protected pictures from the picture selection screen. See “Selecting Pictures” (93) for more information.

Note that formatting the camera’s internal memory or the memory card will permanently delete protected files (138).

Protected pictures are recognized by the icon (7, 70).

Rotate Image

▶ button (Playback mode) → MENU (Playback menu) → Rotate image

Specify the orientation in which recorded pictures are displayed with playback. Still pictures can be rotated 90 degrees clockwise or 90 degrees counterclockwise. Pictures that were recorded in portrait (“tall”) orientation can be rotated up to 180 degrees in either direction.

Select a picture in the picture selection screen (93). When the **Rotate image** screen is displayed, press the multi selector ◀ or ▶ to rotate the picture 90 degrees.

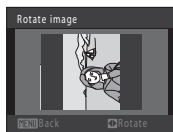

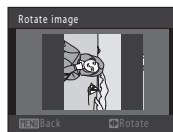
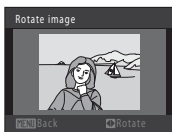

Rotate 90 degrees counterclockwise



Rotate 90 degrees clockwise



Press the OK button to finalize display orientation, and save orientation data with the picture.

Voice Memos

 button (Playback mode) → MENU (Playback menu) →  Voice memo

Use the camera's built-in microphone to record voice memos for pictures.

Recording Voice Memos

- 1 Display the desired picture in full-frame playback mode ( 28) or thumbnail playback mode ( 69) and press the **MENU** button.

The playback menu is displayed.

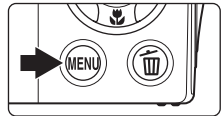

- 2 Use the multi selector to choose  **Voice memo** and press the **OK** button.

The screen for recording voice memos is displayed.

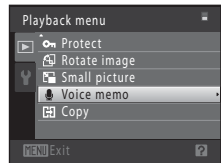

- 3 Press and hold the **OK** button to record a voice memo.

Recording ends after about 20 seconds or when the **OK** button is released.

Do not touch the built-in microphone during recording.

During recording, **REC** and  blink in the monitor.

When recording ends, the voice memo playback screen is displayed. Follow the instructions in step 3 of "Playing Voice Memos" ( 96) to play the voice memo.

Press the **MENU** button before or after recording a voice memo to return to full-frame playback mode.

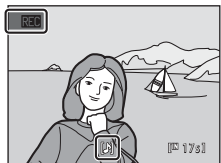
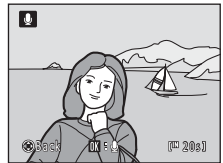



More Information

See "Image/Sound File and Folder Names" ( 151) for more information.

Playing Voice Memos

Pictures for which voice memos have been recorded are indicated by  in full-frame playback mode.

- 1 Select the desired picture in full-frame playback mode ( 28) or thumbnail playback mode ( 69) and press the **MENU** button.

The playback menu is displayed.

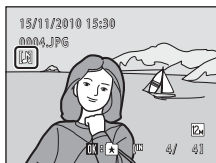

- 2 Use the multi selector to choose  **Voice memo** and press the **OK** button.

The voice memo playback screen is displayed.

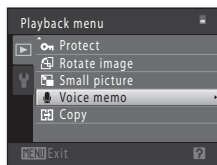

- 3 Press the **OK** button to play the voice memo.



Press the **OK** button again to stop playback.

Rotate the zoom control to **T** or **W** during playback to adjust playback volume.

Press the **MENU** button before or after playing a voice memo to return to full-frame playback mode.



Deleting Voice Memos

Select a picture with a voice memo and press the  button. Use the multi selector to choose  and press the **OK** button. Only the voice memo will be deleted.

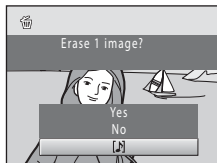

Notes on Voice Memos



- When a picture with a voice memo attached is deleted, both the picture and its voice memo are deleted.
- If a voice memo already exists for the current picture, it must be deleted before a new voice memo can be recorded.
- The COOLPIX S205 is not able to record a voice memo for pictures taken with another make or model of digital camera.



Copy (Copy Between Internal Memory and Memory Card)

 button (Playback mode) → MENU (Playback menu) →  Copy

Copy pictures between the internal memory and a memory card.

- 1 Use the multi selector to select an option from the copy screen and press the  button.

 → : Copy pictures from internal memory to memory card.

 → : Copy pictures from memory card to internal memory.

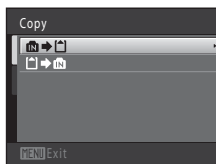



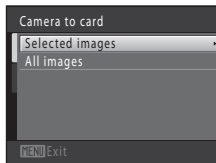

- 2 Select a copy option and press the  button.

Selected images: Copy pictures selected from the picture selection screen ( 93).

All images: Copy all pictures.



Notes on Copying Pictures

- JPEG-, AVI-, and WAV-format files can be copied. Files recorded in any other format cannot be copied.
- If voice memos ( 95) are attached to pictures selected for copying, voice memos are copied with the pictures.
- Operation is not guaranteed with pictures taken with another make of camera or that have been modified on a computer.
- When copying pictures selected for a **Print set** ( 87), the print set marking is not copied. However, **Protect** ( 94) settings are copied with pictures.
- Pictures or movies copied from the internal memory or a memory card cannot be displayed in auto sort mode ( 80).
- When pictures added to albums ( 74) are copied, the copies are not automatically added to the same albums as the original pictures.

"Memory contains no images." Message

If there are no pictures stored on the memory card when playback mode is applied, the message **Memory contains no images.** will be displayed. Press the MENU button to display the copy option screen, and copy the pictures stored in the camera's internal memory to the memory card.

More Information

See "Image/Sound File and Folder Names" ( 151) for more information.

Editing Functions

Use the COOLPIX S205 to edit pictures in-camera and store them as separate files (📖 151). The editing functions described below are available.

Editing function	Description
Quick retouch (📖 100)	Easily create retouched copies in which contrast and saturation have been enhanced.
D-Lighting (📖 101)	Create a copy of the current picture with enhanced brightness and contrast, brightening dark portions of the picture.
Skin softening (📖 102)	The camera detects faces and creates a copy of the picture with softer skin tones in the faces of portrait subjects.
Small picture (📖 104)	Create a small copy of pictures suitable for use as e-mail attachments.
Crop (📖 105)	Enlarge the image or refine the composition and create a copy containing only the portion visible in the monitor.

✔ Notes on Picture Editing

- Pictures taken at an **Image mode** setting of **69 3968x2232** (📖 37) cannot be edited.
- The COOLPIX S205 editing functions are not available for pictures taken with another model of digital cameras.
- If no face is recognized in a picture, a copy cannot be created using the skin softening option (📖 102).
- Edited copies created with this camera may not be displayed properly on a different model of digital camera. It may also be impossible to transfer them to a computer using a different model of digital camera.
- Editing functions are not available when there is not enough free space in the internal memory or on the memory card to store the edited copies.

📎 Restrictions on Picture Editing

When an edited copy is further modified with another editing function, check the following restrictions.

Editing function used	Editing function to add
Quick retouch D-Lighting	The skin softening, small picture and crop functions can be added. The quick retouch and D-Lighting functions cannot be used together.
Skin softening	The quick retouch, D-Lighting, small picture, and crop function can be added.
Small picture Crop	Another editing function cannot be added.

- Copies created with editing functions cannot be further edited with the same function used to create them.
- When combining the small picture or crop function and another editing function, use the small picture and crop functions after other editing functions have been applied.
- The skin softening function can be added to the picture taken with skin softening (📖 64).

 **Original and Edited Pictures**

- Copies created with editing functions are not deleted if the original pictures are deleted. The original pictures are not deleted if copies created with editing functions are deleted.
- Edited copies are stored with the same recording date and time as the original.
- Print marking (📖 87) and protect settings (📖 94) do not remain effective in edited copies.

Picture Editing

Quick Retouch: Enhancing Contrast and Saturation

Quick retouch can be used to easily create retouched copies in which contrast and saturation have been enhanced. New copies are stored as separate files.

- 1 Select the desired picture from full-frame (📖 28) or thumbnail (📖 69) playback mode and press the **MENU** button.

The playback menu is displayed.

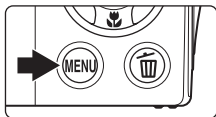

- 2 Use the multi selector to choose  **Quick retouch** and press the **OK** button.

The original version is displayed on the left and the edited version is displayed on the right.

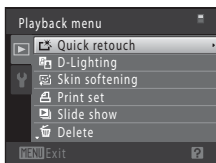

- 3 Press the multi selector **▲** or **▼** to choose the degree of enhancement performed and press the **OK** button.

A new copy is created.

To exit without saving the copy, press the **MENU** button.

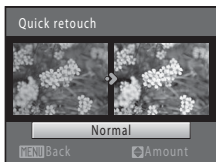

Copies created with the quick retouch option can be recognized by the  icon displayed during playback.

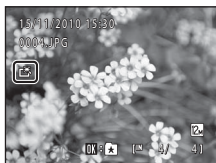

More Information

See "Image/Sound File and Folder Names" (📖 151) for more information.

D-Lighting: Enhancing Brightness and Contrast

D-Lighting can be used to create copies with enhanced brightness and contrast, brightening dark portions of a picture. New copies are stored as separate files.

- 1 Select the desired picture from full-frame ( 28) or thumbnail ( 69) playback mode and press the **MENU** button.

The playback menu is displayed.



- 2 Use the multi selector to choose  **D-Lighting** and press the **OK** button.

The original version is displayed on the left and the edited version is displayed on the right.

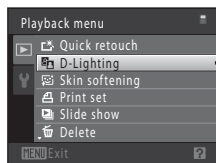

- 3 Choose **OK** and press the **OK** button.

A new copy with enhanced brightness and contrast is created.

To exit without saving the copy, choose **Cancel** and press the **OK** button.

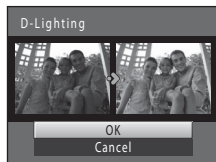

D-Lighting copies can be recognized by the  icon displayed during playback.



More Information

See "Image/Sound File and Folder Names" ( 151) for more information.

Skin Softening: Softening Skin Tones

The camera detects faces in pictures and creates a copy with softer facial skin tones. Copies created with the skin softening function are stored as separate files.

- 1 Select the desired picture in full-frame (📖 28) or thumbnail (📖 69) playback mode and press the **MENU** button.

The playback menu is displayed.

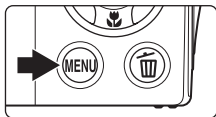

- 2 Use the multi selector to choose  Skin softening and press the **OK** button.

The screen for selecting the degree of softening is displayed.

If no faces are recognized in the picture, an alert is displayed and the camera returns to the playback menu.

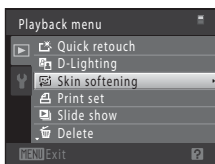

- 3 Press the multi selector **▲** or **▼** to choose the degree of enhancement performed and press the **OK** button.

The confirmation screen is displayed with the face to which skin softening was applied enlarged at the center of the monitor.

To exit without saving the copy, press the **MENU** button.

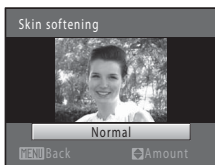

- 4 Check the enhancement performance.

Skin tones in up to 12 faces, in the order of that closest to the center of the frame, are softened.

If more than one face was softened, press the multi selector **◀** or **▶** to display a different face.

To change the degree of effect, press the **MENU** to return to step 3.

Press the **OK** button to display a new, created copy.

Copies created with the skin softening function can be recognized by the  indicator displayed during playback.

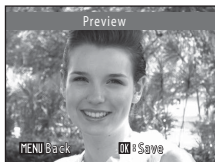



 Note on Skin Softening

Depending upon the direction in which faces are looking, or the brightness of faces, the camera may be unable to accurately recognize faces, or the skin softening function may not perform as expected.

 More Information

See "Image/Sound File and Folder Names" ( 151) for more information.

Small Picture: Resizing Pictures

Create a small copy of the current picture. This feature is useful for displaying on Web pages and using as e-mail attachments. Small copies are stored as JPEG files with a compression ratio of 1:16. The , , and  sizes are available.

- 1 Select the desired picture from full-frame () 28) or thumbnail () 69) playback mode and press the **MENU** button.

The playback menu is displayed.



- 2 Use the multi selector to choose  **Small picture** and press the **OK** button.

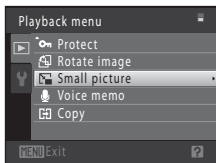

- 3 Choose the desired copy size and press the **OK** button.

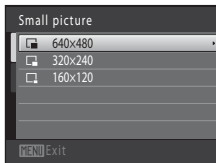

- 4 Choose **Yes** and press the **OK** button.

A new, smaller copy is created.

To exit without saving the copy, choose **No** and press the **OK** button.

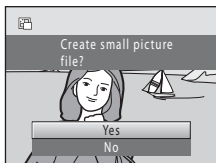

The copy is displayed with a gray frame.



More Information

See "Image/Sound File and Folder Names" () 151) for more information.

Crop: Creating a Cropped Copy

Create a copy containing only the portion visible in the monitor when **MENU**  is displayed with playback zoom ( 72) enabled. Cropped copies are stored as separate files.

1 Rotate the zoom control to **T** () in full-frame playback mode to zoom in on the image.

To crop a picture displayed in “tall” (portrait) orientation, zoom in on the picture until the black bars displayed on the both sides of the monitor disappear. The cropped picture will be displayed in landscape orientation.

To crop the picture in its current “tall” (portrait) orientation, first use the **Rotate image** option ( 94) to rotate the picture so that it is displayed in landscape orientation. Next, enlarge the picture for cropping, crop the picture, and then rotate the cropped picture back to “tall” (portrait) orientation.

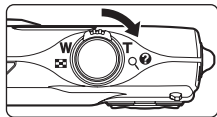

2 Refine crop composition.

Rotate the zoom control to **T** () or **W** () to adjust the zoom ratio.

Press the multi selector , , , or  to scroll the picture until only the portion you want to copy is visible in the monitor.



3 Press the **MENU** button.

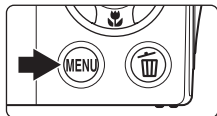

4 Use the multi selector to choose **Yes** and press the button.

A cropped copy is created.

To exit without saving the copy, choose **No** and press the  button.

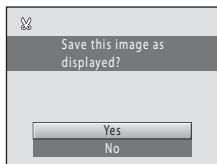



Image Size





As the area to be saved is reduced, the image size (pixels) of the cropped copy is also reduced. When the size of the cropped copy is 320 × 240 or 160 × 120, a gray frame is displayed around the picture during playback, and the small picture icon  or  is displayed at the left of the monitor in full-frame playback mode.

More Information

See “Image/Sound File and Folder Names” ( 151) for more information.

Recording Movies

To shoot movies with sound recorded via the built-in microphone, enter shooting mode and follow the steps below.

- 1 Press the  button in shooting mode to display the shooting mode menu and press the multi selector  or  to select , and then press the  button.



The maximum movie length that can be recorded is displayed in the monitor ( 108). The maximum recording time for a single movie is 29 minutes. The maximum file size for a single movie is 2 GB, even when there is sufficient free space on the memory card for a larger movie file.

- 2 Press the shutter-release button all the way down to start recording.

The camera focuses on the subject at the center of the frame.

A progress bar at the bottom of the monitor shows the amount of recording time remaining.

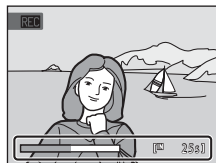

To end recording, press the shutter-release button all the way down a second time.

Recording stops automatically when the maximum movie length has been recorded.

✓ Recording Movies

- Optical zoom cannot be adjusted once movie recording begins. Digital zoom cannot be applied before movie recording begins. However, digital zoom can be applied (up to 2x) while movies are being recorded.
- There may be some degradation in image quality when digital zoom is used.
- The angle of view (recordable area) with movie recording is narrower than with shooting of still pictures.
- Smear (📖 148) visible in the monitor with movie recording will be recorded with movies. Avoiding bright objects such as the sun, reflections of the sun, and electric lights when recording movies is recommended.

✓ Note on Saving Movies

After a movie has been recorded, it is not fully saved to the internal memory or memory card until monitor display returns to the shooting display. **Do not open the battery-chamber/memory card slot cover** before movies have been fully saved. Removing the memory card while movies are being saved could result in loss of data or in damage to the camera or card.

✓ Note on Autofocus

When  **Single AF** (default setting) is selected for **Autofocus mode** in movie menu, focus locks when the shutter-release button is pressed (📖 109).

✍ Functions Available with Movie Recording



- Macro mode (📖 33) is available. Confirm settings before starting movie recording. The flash (📖 30), self-timer (📖 32) and exposure compensation (📖 34) cannot be used.
- Press the **MENU** button to display the  (movie) menu (📖 108) and adjust **Movie options**, **Autofocus mode**, and **Electronic VR**.

The Movie Menu



The movie menu can be used to adjust **Movie options** (📖 108), **Autofocus mode** (📖 109), and **Electronic VR** (📖 109) settings.

Select  (Movie) from the movie mode, then press the **MENU** button (📖 10) to display the movie menu and use the multi selector (📖 9) to modify and apply settings.



Movie Options

 (Movie) → **MENU** (Movie menu) →  (Movie options)

The movie menu offers the options shown below.

Option	Image size and frame rate
 TV movie 640 (default setting)	Image size: 640 × 480 pixels Frame rate: 30 frames per second
 Small size 320	Image size: 320 × 240 pixels Frame rate: 30 frames per second

Movie Options and Maximum Movie Length

Option	Internal memory (approx. 47 MB)	Memory card (4 GB)
 TV movie 640 (default setting)	32 s	46 min
 Small size 320	1 min 55 s	2 h 45 min

* All figures are approximate. The maximum recording time may vary with make of memory card.

* The maximum recording time for a single movie is 29 minutes. The maximum file size for a single movie is 2 GB, even when there is sufficient free space on the memory card for a larger movie file. The maximum movie length that can be recorded for a single movie is displayed during recording.



More Information

See "Image/Sound File and Folder Names" (📖 151) for more information.



Autofocus Mode

 (Movie) → MENU (Movie menu) →  Autofocus mode

Choose how the camera focuses in movie mode.

Option	Description
 Single AF (default setting)	Focus is locked when the shutter-release button is pressed.
 Full-time AF	Camera focuses continuously during movie recording. To prevent sound of camera focusing from interfering with recording, use of Single AF is recommended

Electronic VR

 (Movie) → MENU (Movie menu) →  Electronic VR

Choose whether to use electronic VR (vibration reduction) when shooting movies.

Option	Description
 On	Reduce the effects of camera shake in all movie modes.
Off (default setting)	Disable electronic VR

At setting other than **Off**, the icon for the current setting is displayed in the monitor ( 6).

Movie Playback

In full-frame playback mode (📖 28), movies are recognized by the **Movie options** icon (📖 108). To play a movie, display it in full-frame playback mode and press the **OK** button.

Rotate the zoom control to **T** or **W** to adjust playback volume.

Playback controls are displayed at the top of the monitor. Press the multi selector ◀ or ▶ to choose a control, then press the **OK** button to perform the selected operation. The operations described below are available.

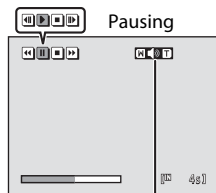

During playback

Volume indicator

To	Use	Description
Rewind	⏮	Hold down the OK button to rewind movie.
Fast-forward	⏭	Hold down the OK button to fast-forward movie.
Pause	⏸	Press the OK button to pause playback. The following operations can be performed while playback is paused using the controls displayed at top in the monitor.
		⏮ OK Press the OK button to rewind movie one frame. Hold down the OK button for continuous frame-by-frame rewind.
		⏭ OK Press the OK button to advance movie one frame. Hold down the OK button for continuous frame-by-frame advance.
	▶ OK Press the OK button to resume playback.	
End	⏹	Press the OK button to return to full-frame playback mode.

Deleting Movie

Select a movie and press the **Delete** icon in full-frame playback mode (📖 28) or thumbnail playback mode (📖 69). A confirmation dialog is displayed. Choose **Yes** and press the **OK** button to delete the movie, or choose **No** and press the **OK** button to return to the normal playback display without deleting the movie.



Movie Playback

Movies recorded by a camera other than the COOLPIX S205 cannot be played back.

Connecting to a TV

Connect the camera to a television using the Audio Video cable EG-CP14 (available separately from Nikon) to play back pictures on a television.

1 Turn off the camera.

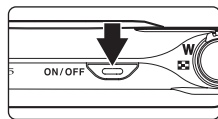

2 Connect the camera to the TV using the audio/video cable.

Connect the yellow plug to the video-in jack and the white plug to the audio-in jack on the TV.

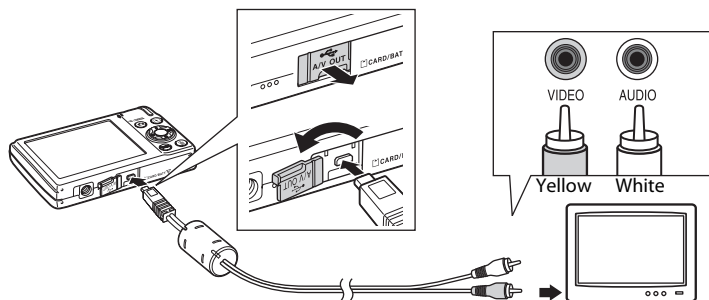

3 Tune the television to the video channel.

See the documentation provided with your television for details.

4 Hold down the button to turn on the camera.

The camera enters playback mode and pictures are displayed on the television.

While connected to the TV, the camera monitor will remain off.



Connecting the Audio/Video Cable

When connecting the audio/video cable, be sure that the camera connector is properly oriented. Do not use force when connecting the audio/video cable to the camera. When disconnecting the audio/video cable, do not pull the connector at an angle.

Video Mode

Be sure that the camera's video mode setting conforms to the standard used by your television. The video mode setting is specified from the **Video mode** (📖 139) option in the **Set up** menu (📖 125).

Connecting to a Computer

Use the supplied USB cable to connect the camera to a computer, and copy (transfer) pictures to a computer with the supplied Nikon Transfer software.

Before Connecting the Camera

Install the Software

Before connecting the camera to a computer, software, including Nikon Transfer, ViewNX for displaying transferred pictures, and Panorama Maker for creating panorama photos, must be installed using the supplied Software Suite CD.

For more information on installing the software, refer to the *Quick Start Guide*.

Compatible Operating Systems

Windows

- Windows 7 (Home Basic/Home Premium/Professional/Enterprise/Ultimate editions)
- Windows Vista Service Pack 2 (Home Basic/Home Premium/Business/Enterprise/Ultimate editions)
- 32-bit versions of Windows XP Service Pack 3 (Home Edition/Professional)

Macintosh

Mac OS X (version 10.4.11, 10.5.8, 10.6.2)

Refer to the Nikon website for the latest information on operating system compatibility.

Note on Computer Connection

Disconnect other USB devices such as commercial USB chargers from the computer. Simultaneous connection of the camera and other USB devices to the computer could result in operation malfunction or excessive supply of power to the camera, causing damage to the camera or memory card. Refer to the documentation supplied with other USB devices for more information.

Notes on Power Source

- When connecting the camera to a computer to transfer pictures, use a fully charged battery to prevent the camera from turning off unexpectedly.
- When the camera is connected to a computer via the supplied USB cable with **Auto** (default setting) selected for the **Charge by computer** option in the setup menu, the battery inserted into the camera is automatically charged using power supplied by the computer (📖 117, 140). Pictures can be transferred while the battery is charging.
- If the AC Adapter EH-62D (📖 149) (available separately) is used, COOLPIX S205 can be powered from an electrical outlet. Do not use any other make or model of AC adapter as they may cause the camera to overheat or malfunction.

Transferring Pictures from the Camera to a Computer

- 1 Start the computer to which Nikon Transfer was installed.
- 2 Be sure that the camera is off.
- 3 Connect the camera to the computer using the supplied USB cable.

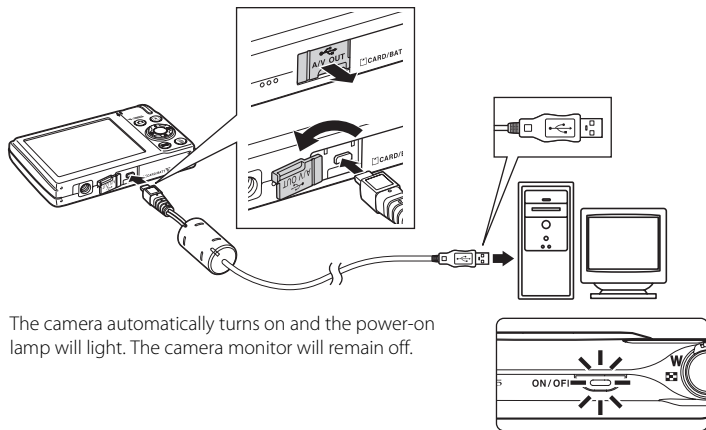

✓ Connecting the USB Cable

- Be sure that connectors are properly oriented. Do not attempt to insert connectors at an angle, and do not use force when connecting or disconnecting the USB cable.
- The connection may not be recognized if the camera is connected to the computer via a USB hub.

4 Start Nikon Transfer installed on the computer.

• Windows 7

When the **Devices and Printers** ► **S205** screen is displayed, click **Change program** under **Import pictures and videos**. Select **Copy pictures to a folder on my computer** in the **Change program** dialog and click **OK**.

Double-click **Copy pictures to a folder on my computer** on the **Devices and Printers** ► **S205** screen.

• Windows Vista

When the **AutoPlay** dialog is displayed, click **Copy pictures to a folder on my computer using Nikon Transfer**.

• Windows XP

When the action selection dialog is displayed, select **Nikon Transfer Copy pictures to a folder on my computer** and click **OK**.

• Mac OS X

Nikon Transfer will start automatically when the camera is connected to the computer if **Yes** was selected in the Auto-Launch setting dialog when Nikon Transfer was first installed.

- If charge for the battery inserted into the camera is low, the computer may not recognize the camera. If the camera is not recognized, pictures will not be transferred. When battery charging starts automatically using power supplied by the computer, wait until battery charge has reached a sufficient level to begin transfer.
- If there are a large number of images on the memory card, it may take some time for Nikon Transfer to start.

5 Confirm that the source device is displayed in the transfer options **Source** panel and click **Start Transfer**.

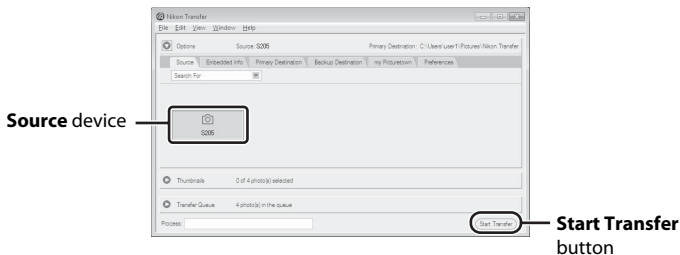

At the Nikon Transfer default settings, all pictures are transferred to the computer.

At the Nikon Transfer default settings, ViewNX starts automatically when transfer is complete and transferred pictures can be viewed.

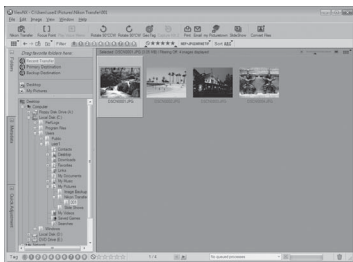

For more information on using Nikon Transfer or ViewNX, refer to help information contained in Nikon Transfer or ViewNX (📖 116).

Disconnecting the camera

Do not turn off the camera or disconnect the camera from the computer during transfer.

When transfer is complete, turn off the camera and disconnect the USB cable. The camera turns off automatically if there is no communication with the computer for 30 minutes while the camera is connected via the USB cable.

✔ Charging the Battery

The charge lamp slowly blinks green while the battery inserted into the camera is charging (📖 117).

📄 Using a Card Reader

The pictures stored on the memory card inserted into a card reader or similar device can also be transferred to the computer using Nikon Transfer.

- If the memory card capacity is 2 GB or more, or if the memory card is SDHC-compliant, the card reader or similar device must support these memory card specification.
- Insert a memory card into the card reader or similar device, and refer to the steps 4 and 5 (📖 114) to transfer pictures.
- To transfer pictures stored in the camera's internal memory to the computer, the pictures must first be copied to a memory card using the camera (📖 97).

Starting Nikon Transfer or ViewNX Manually

Windows

Choose **Start** menu>**All Programs**>**Nikon Transfer**>**Nikon Transfer** (or **All Programs**>**ViewNX**>**ViewNX**).

Double-clicking the Nikon Transfer or ViewNX shortcut icon on the desktop will also start Nikon Transfer or ViewNX.

Macintosh

Open **Applications** and double-click **Nikon Software**>**Nikon Transfer**>**Nikon Transfer** (or **Nikon Software**>**ViewNX**>**ViewNX**).

Clicking the Nikon Transfer or ViewNX icon on the Dock will also start Nikon Transfer or ViewNX.

Viewing Nikon Transfer and ViewNX Help Information

For more information on Nikon Transfer or ViewNX, start Nikon Transfer or ViewNX and select **Nikon Transfer Help** or **ViewNX Help** from the **Help** menu.

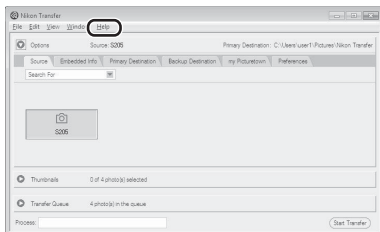

Panorama Creation with Panorama Maker

- Use a series of pictures taken in **Panorama assist** scene mode ( 59) to create a single panorama photo with Panorama Maker.
- Panorama Maker can be installed on a computer using the supplied Software Suite CD.
- After installation is complete, follow the procedure described below to start Panorama Maker.

Windows

Choose **Start** menu>**All Programs**>**ArcSoft Panorama Maker 5**>**Panorama Maker 5**.

Macintosh

Open **Applications** and double-click the **Panorama Maker 5** icon.

- For more information on using Panorama Maker, refer to the on-screen instructions and help information contained in Panorama Maker.

Image File Names and Folder Names

See "Image/Sound File and Folder Names" ( 151) for more information.

Charging While Connecting to a Computer

When connecting the camera to a computer via the supplied USB cable while **Auto** (default setting) is selected for the **Charge by computer** option (📖 140) in the setup menu, the battery inserted into the camera is automatically charged using power supplied by the computer.

See “Before Connecting the Camera” (📖 112) and “Transferring Pictures from the Camera to a Computer” (📖 113) for more information on connecting the camera to a computer.

Charge Lamp

The following chart explains charge lamp status when the camera is connected to a computer.

Charge lamp	Description
Slow blinking (green)	Battery charging.
Off	Not charging. If the charge lamp changes from slow blinking (green) to off while the power-on lamp is lit, charging is complete.
Fast blinking (green)	<ul style="list-style-type: none"> Operating temperature range exceeded. Charge the battery indoors with an ambient temperature of 5 °C to 35 °C (41 °F to 95 °F) before use. A USB cable is not correctly connected or the battery is faulty. Reconnect the USB cable correctly or replace the battery. Computer is in sleep mode and does not supply power. Reboot a computer. The battery cannot be charged as computer's specifications or setting does not support power supply to the camera.

Notes on Charging with Connection to a Computer

- The battery cannot be charged, nor can data be transferred, when the camera is connected to a computer before the camera's date and time have been set (📖 18). If the camera's clock battery (📖 130) has been exhausted, the date and time must be reset before the battery can be charged or images can be transferred with connection to a computer. In this case, use the Charging AC Adapter EH-68P (📖 14) to charge the battery and then set the camera's date and time.
- If the camera is turned off, charging will also stop.
- If a computer enters sleep mode while charging, charging will stop and the camera may be turned off.
- When disconnecting the camera from a computer, turn the camera off and then disconnect the USB cable.
- It may take longer to charge the battery with connection to a computer than with charging using the Charging AC Adapter EH-68P. Charging time increases when image are transferred while the battery is charging.
- When the camera is connected to a computer, an application installed on the computer, such as Nikon Transfer, may start. If the camera was connected to the computer for the sole purpose of charging the battery, exit the application.
- The camera turns off automatically if there is no communication with the computer for 30 minutes after the battery has finished charging.
- Depending upon computer specifications, settings, and power supply and allocation, it may be impossible to charge the battery inserted into the camera via computer connection.

Connecting to a Printer

Users of PictBridge-compatible (📖 166) printers can connect the camera directly to the printer and print pictures without using a computer. Follow the procedures below to print pictures.

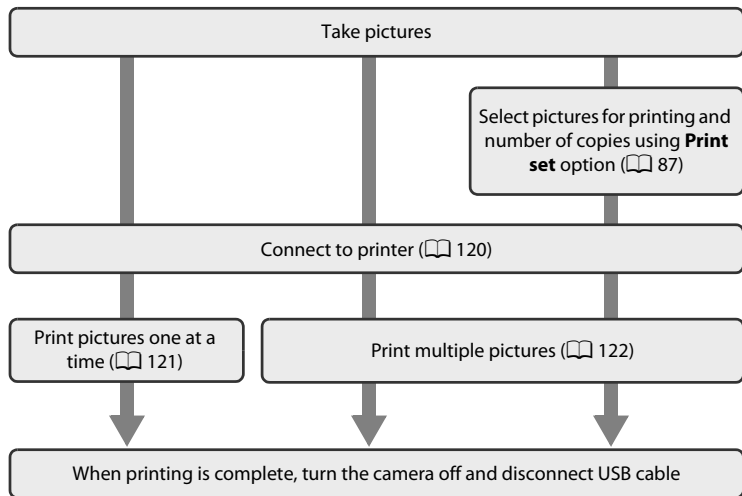

✔ Notes on Power Source

- When connecting the camera to a printer, use a fully charged battery to prevent the camera from turning off unexpectedly.
- If the AC Adapter EH-62D (available separately) is used, COOLPIX S205 can be powered from a home electrical outlet. Do not use any other make or model of AC adapter as they may cause the camera to heat up or malfunction.

📷 Printing Pictures

In addition to printing pictures transferred to a computer and printing over a direct camera-to-printer connection, the following options are also available for printing pictures:

- Inserting a memory card into a DPOF-compatible printer's card slot
- Taking a memory card to a digital photo lab

For printing using these methods, specify the pictures and the number of prints each to the memory card using the **Print set** option in the playback menu (📖 87).

Connecting the Camera to a Printer

- 1 Turn off the camera.

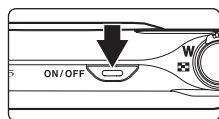

- 2 Turn on the printer.

Check printer settings.

- 3 Connect the camera to the printer using the supplied USB cable.

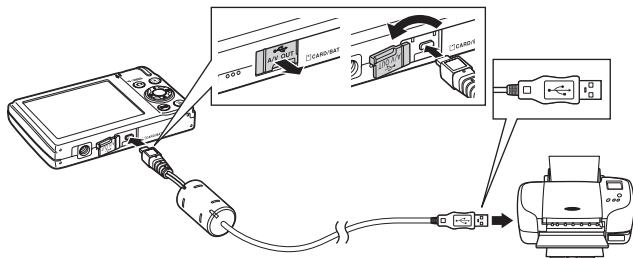

- 4 The camera is automatically turned on.

When properly connected, the **PictBridge** startup screen (①) will be displayed in the camera monitor, followed by the **Print selection** screen (②).

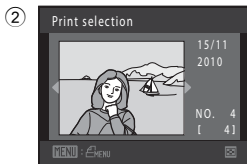
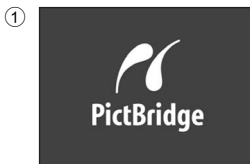
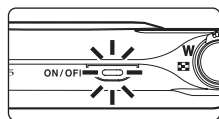

✓ Connecting the USB Cable

When connecting the USB cable, be sure that the connectors are properly oriented. Do not use force when connecting the USB cable. When disconnecting the USB cable, do not pull the connector at an angle.

✓ If the PictBridge Screen is not Displayed

Turn off the camera and disconnect the USB cable. Set **Charge by computer** (📖 140) in the camera's setup menu to **Off**, then connect the camera again.

Printing Pictures One at a Time

After properly connecting the camera to the printer (📖 120), follow the procedure described below to print a picture.

- 1 Use the multi selector to choose the desired picture and press the **OK** button.

Rotate the zoom control to **W** (🖼️) to switch to 12-thumbnail display, and to **T** (📷) to switch back to full-frame playback.

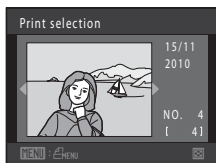

- 2 Choose **Copies** and press the **OK** button.

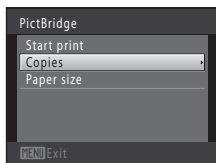

- 3 Choose the number of copies (up to nine) and press the **OK** button.

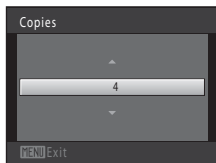

- 4 Choose **Paper size** and press the **OK** button.

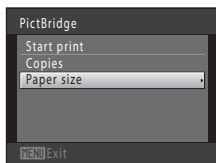

- 5 Choose the desired paper size and press the **OK** button.

To specify paper size using printer settings, choose **Default** in the paper size menu.

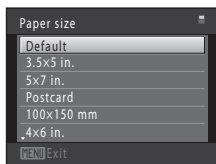

- 6** Choose **Start print** and press the **OK** button.

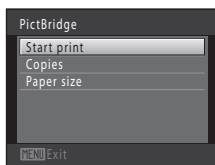

- 7** Printing begins.

Monitor display returns to the print selection screen shown in step 1 when printing is complete.

To cancel printing before all copies have been printed, press the **OK** button.

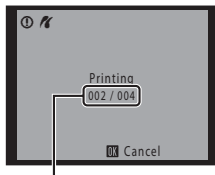

Current number of copies/
total number of prints

Printing Multiple Pictures

After properly connecting the camera to the printer (📖 120), follow the procedure described below to print multiple pictures.

- 1** When the **Print selection** screen is displayed, press the **MENU** button.

The **Print menu** screen is displayed.

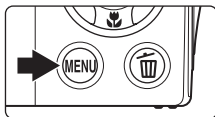

- 2** Use the multi selector to choose **Paper size** and press the **OK** button.

To exit the print menu, press the **MENU** button.

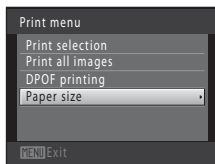

- 3** Choose the desired paper size and press the **OK** button.

To specify paper size using printer settings, choose **Default** in the paper size menu.

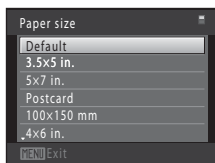

- 4** Choose **Print selection**, **Print all images** or **DPOF printing** and press the **OK** button.

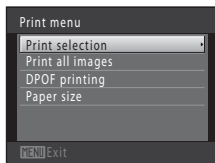

Print selection

Choose pictures (up to 99) and the number of copies (up to nine) of each.

- Press the multi selector ◀ or ▶ to select pictures, and press ▲ or ▼ to specify the number of copies for each.
- Picture selected for printing can be recognized by the check mark (✓) and the numeral indicating the number of copies to be printed. If no copies have been specified for pictures, the selection is canceled.
- Rotate the zoom control to **T** (🔍) to switch to full-frame playback. Rotate the zoom control to **W** (🔲) to switch back to 12-thumbnail display.
- Press the **OK** button when setting is complete.
- When the menu shown at right is displayed, choose **Start print** and press the **OK** button to start printing. Choose **Cancel** and press the **OK** button to return to the print menu.

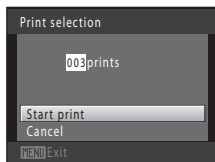

Print all images

One copy each of all pictures stored in the internal memory, or on the memory card, is printed.

- When the menu shown at right is displayed, choose **Start print** and press the **OK** button to start print. Choose **Cancel** and press the **OK** button to return to the print menu.

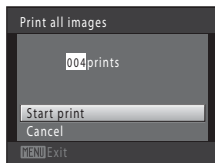

DPOF printing

Print pictures for which a print order was created using the **Print set** option (📖 87).

- When the menu shown at right is displayed, choose **Start print** and press the **OK** button to start printing. Choose **Cancel** and press the **OK** button to return to the print menu.
- To view the current print order, choose **View images** and press the **OK** button. To print pictures, press the **OK** button again.

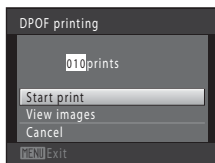

5 Printing begins.

Monitor display returns to the print menu (step 2) when printing is complete.

To cancel printing before all copies have been printed, press the **OK** button.

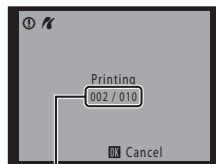





























Current print/
total number of prints

Paper size







The camera supports the following paper sizes: **Default** (the default paper size for the current printer), **3.5x5 in.**, **5x7 in.**, **100x150 mm**, **4x6 in.**, **8x10 in.**, **Letter**, **A3**, and **A4**. Only sizes supported by the current printer will be displayed. To specify paper size using printer settings, choose **Default** in the paper size menu.

Setup Menu

The setup menu contains the following options.

	Menus	 127
	Choose how menus are displayed.	
	Welcome screen	 128
	Choose whether or not a welcome screen is displayed when the camera is turned on.	
	Date	 129
	Set camera clock and choose home and destination time zones.	
	Monitor settings	 132
	Adjust photo information display, post-shooting image review, and monitor brightness settings.	
	Date imprint	 133
	Imprint shooting date and time on pictures.	
	Electronic VR	 134
	Choose whether to use electronic VR (vibration reduction) when taking still pictures.	
	Motion detection	 135
	Enable or disable motion detection, which reduces the effects of subject movement and camera shake in still pictures.	
	AF assist	 136
	Enable or disable AF-assist illumination.	
	Digital zoom	 136
	Enable or disable digital zoom.	
	Sound settings	 137
	Adjust sound settings.	
	Auto off	 137
	Set time before camera enters standby mode for saving power.	
	Format memory/Format card	 138
	Format internal memory or memory card.	
	Language	 139
	Choose the language used for camera monitor display.	
	Video mode	 139
	Adjust settings necessary for connection to television.	



Setup Menu

-  **Charge by computer**  140
Choose whether or not to charge the camera battery when connecting to a computer via the USB cable.
-  **Blink warning**  141
Specify whether or not the camera detects human subjects that have blinked with shooting using face priority.
-  **Reset all**  143
Restore camera settings to the default.
- Ver** **Firmware version**  145
Display camera firmware version.

Displaying the Setup Menu

- 1 Press the **MENU** button to display the menu screen.



If the **MENU** button was pressed in Scene mode, press the multi selector ( 9)  to display the tabs.

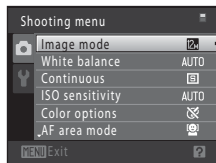

- 2 Press the multi selector ( 9) .

Tab selection is activated.

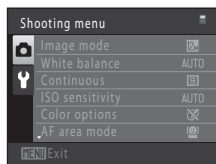

3 Press ▲ or ▼ to select the Y tab.

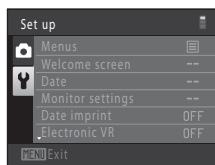

4 Press ► or the OK button.

The setup menu items can be selected.

Use the multi selector to choose items and adjust menu options (📖 9).

To exit the setup menu, press the MENU button or ◀ to select a different tab.

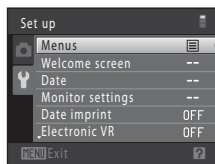

Menu

MENU button → Y (Setup menu) (📖 126) →  Menu

Choose the initial menu displayed.

Text (default setting)

Menus are displayed in list format.

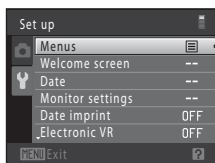



Icons

All menu items can be displayed in a single screen.

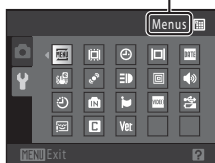
Menu names



Welcome Screen

MENU button →  (Setup menu) (📖 126) →  Welcome screen

Choose whether or not a welcome screen is displayed when the camera is turned on.

None (default setting)

The camera enters shooting or playback mode without displaying the welcome screen.

COOLPIX

The camera displays a welcome screen and enters shooting or playback mode.

Select an image

Displays a picture selected for the welcome screen. When the picture selection screen is displayed, select a picture (📖 93) and press  button.

- As the selected picture is stored by the camera, it will be displayed when the camera is turned on even if the original picture is deleted.
- Pictures taken at an **Image mode** (📖 37) setting of  **3968×2232**, and copies created at a size of 320 × 240 or smaller using the small picture (📖 104) or crop (📖 105) function, cannot be used.

Date

MENU button →  (Setup menu) (📖 126) →  Date

Set the camera clock.



Date

Set camera clock to current date and time.

Use the multi selector to set the date and time in the date screen.

- Highlight a different item (day, month, year, hour, minute, and the order in which day, month, and year are displayed): press ◀ or ▶.
- Edit the highlighted item: press ▲ or ▼.
- Apply the setting: select the order in which day, month, and year are displayed and press the  button (📖 19).

Time zone

 **Home time zone** can be specified and daylight saving enabled or disabled from **Time zone** options. When the destination time zone () is selected, local time (📖 131) is automatically calculated and date and time in the selected region are recorded with pictures. Useful when traveling.

Selecting Travel Destination Time Zone

- 1 Use the multi selector to choose **Time zone** and press the  button.

The **Time zone** menu is displayed.

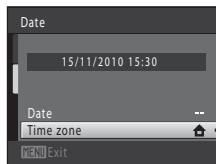

- 2 Choose  **Travel destination** and press the  button.

The date and time displayed in the monitor changes according to the region currently selected.

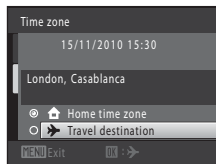

3 Press **▶**.

The time zone selection screen is displayed.

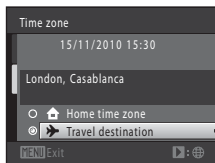
**4** Press **◀** or **▶** to choose the travel destination time zone.

Press **▲** in a time zone where daylight saving is in effect to enable the daylight saving time function and automatically advance the time by one hour. The  icon will be displayed at the top of the monitor. Press **▼** to disable the daylight saving time function.

Press the **OK** button to choose the travel destination time zone.

While the travel destination time zone is selected, the  icon will be displayed in the monitor when the camera is in shooting mode.

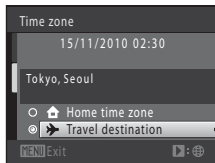
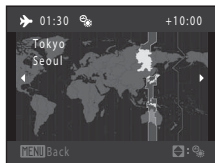
**✓** **Notes on the Clock Battery**

The camera clock is powered by the clock battery. The clock battery charges when the main battery is inserted or an AC adapter is connected, and can provide several days of backup power after about ten hours of charging.

✎ **Home Time Zone**

- To switch to the home time zone, choose **Home time zone** in step 2 and press the **OK** button.
- To change the home time zone, choose **Home time zone** in step 2 and complete steps 3 and 4.

✎ **Daylight Saving Time**

When daylight saving time starts or ends, turn the daylight saving time function on or off from the time zone selection screen displayed in step 4.

📅 **Imprinting the Date on Pictures**



Enable date imprint from the **Date imprint** option ( 133) in the setup menu after the date and time have been set. When the **Date imprint** option is enabled, pictures will be recorded with shooting date imprinted on them.

 **Time Zones**

The camera supports the time zones listed below. For time zone not listed below, set the camera clock to local time.

UTC +/-	Location	UTC +/-	Location
-11	Midway, Samoa	+1	Madrid, Paris, Berlin
-10	Hawaii, Tahiti	+2	Athens, Helsinki, Ankara
-9	Alaska, Anchorage	+3	Moscow, Nairobi, Riyadh, Kuwait, Manama
-8	PST (PDT): Los Angeles, Seattle, Vancouver	+4	Abu Dhabi, Dubai
-7	MST (MDT): Denver, Phoenix	+5	Islamabad, Karachi
-6	CST (CDT): Chicago, Houston, Mexico City	+5.5	New Delhi
-5	EST (EDT): New York, Toronto, Lima	+6	Colombo, Dhaka
-4.5	Caracas	+7	Bangkok, Jakarta
-4	Manaus	+8	Beijing, Hong Kong, Singapore
-3	Buenos Aires, Sao Paulo	+9	Tokyo, Seoul
-2	Fernando de Noronha	+10	Sydney, Guam
-1	Azores	+11	New Caledonia
±0	London, Casablanca	+12	Auckland, Fiji

Monitor Settings

MENU button →  (Setup menu) (📖 126) →  Monitor settings

Set the options below.

Photo info

Choose information displayed in the monitor during shooting and playback mode.

Image review

On (default setting): Picture is automatically displayed in the monitor immediately after it is taken and the monitor display returns to shooting mode.

Off: Picture is not displayed after it is taken.





Brightness

Choose from five settings for monitor brightness. The default setting is **3**.

Photo Info

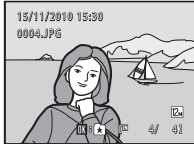
Select whether or not the photo information is displayed in the monitor.

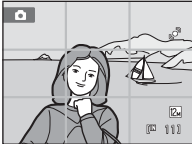
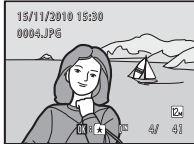
See “The Monitor” (📖 6) for information on indicators displayed in the monitor.

	Shooting mode	Playback mode
Show info		
Auto info (default setting)	Current settings and operational guides are displayed as in Show info above. If no operations are performed for a few seconds, the display will be the same as Hide info . Information will be displayed again when the next operation is performed.	
Hide info		
Framing grid		
	In addition to information shown with Auto info above, a framing grid is displayed to help frame pictures in  (auto) mode. In other shooting modes only the information shown with Auto info is displayed.	The current settings or operation guide is displayed, as in Auto info above.

DATE Date Imprint (Imprinting Date and Time)

MENU button → **Y** (Setup menu) (📖 126) → **DATE** Date imprint

The shooting date and time can be imprinted on the pictures with shooting, allowing the information to be printed even from printers that do not support date printing (📖 90).



Off (default setting)

Date and time are not imprinted on pictures.

DATE Date

Date is imprinted on the pictures.

DATE Date and time

Date and time are imprinted on the pictures.

At settings other than **Off**, the icon for the current setting is displayed in the monitor (📖 6).



✓ Notes on Date Imprint

- Imprinted dates form a permanent part of image data and cannot be deleted. The date and time cannot be imprinted on pictures after they have been taken.
- The date is not imprinted in the following situations:
 - Pictures taken in **Panorama assist** scene mode
 - Movie recording
- Dates imprinted at an **Image mode** setting (📖 37) of **VGA 640 × 480** may be difficult to read. Choose **PC 1024 × 768** or larger when using date imprint.
- The date is recorded using the format selected in the setup menu's **Date** item (📖 18, 129).

📎 Date Imprint and Print Set

When printing from DPOF-compatible printers that support the printing of shooting date and photo information, the date and information can be printed without imprinting this information on them using options in the **Print Set** menu (📖 87).

Electronic VR

MENU button →  (Setup menu) (📖 126) →  Electronic VR

Choose whether or not electronic VR (vibration reduction) is used when taking still pictures.

Auto

Electronic VR is enabled and the effects of camera shake are reduced with shooting of still pictures when all of the following conditions are met.

- The flash is turned off or set to slow sync mode.
- A slow shutter speed is used.
- The **Continuous** setting is set to **Single**
- The subject is dark.

Off (default setting)

Electronic VR is disabled.

When **Auto** is selected,  is displayed in the monitor (📖 6), and electronic VR is applied according to shooting conditions.



Notes on Electronic Vibration Reduction

- Electronic VR does not function when the flash is used, except when slow sync mode is applied. Electronic VR does not function when slow sync with red-eye reduction (📖 54, 55) is used.
- Electronic VR does not function with exposures that exceed a certain length of time.
- Electronic VR is activated only when **ISO sensitivity** (📖 42) is set to **Auto**.
- Electronic VR does not function when **Blink proof** (📖 64) is set to **On** in smart portrait mode.
- Electronic VR does not function in the following scene mode:
 - **Sports** (📖 54)
 - **Night portrait** (📖 54)
 - **Dusk/dawn** (📖 55)
 - **Night landscape** (📖 56)
 - **Museum** (📖 57)
 - **Fireworks show** (📖 58)
 - **Backlight** (📖 58)
- The effectiveness of electronic VR decreases as camera shake increases.
- The picture taken using electronic VR may be somewhat “grainy” in appearance.

Electronic VR for Movies

To compensate for camera shake with movie recording, enable **Electronic VR** (📖 109) from the movie menu (📖 108).

Motion Detection



MENU button →  (Setup menu) (📖 126) →  Motion detection

Enable motion detection to reduce the effects of subject movement and camera shake when shooting still pictures.

Auto (default setting)

When the camera detects subject movement or camera shake, the ISO sensitivity and shutter speed are automatically increased to reduce blurring.

However, motion detection does not function in the following situations.

- When the flash fires
- When **ISO sensitivity** (📖 42) is set to **Fixed range auto** or ISO sensitivity is fixed at a particular value in  (auto) mode
- In  (auto) mode, when **Multi-shot 16** (📖 41) is enabled
- When **Sports, Night portrait, Dusk/dawn, Fireworks show, or Backlight** scene mode is enabled
- When subject tracking mode is enabled
- When recording movies

Off

Motion detection is not enabled.

The current motion detection setting can be confirmed in the camera monitor with shooting (📖 6, 23). The motion detection icon turns green when the camera detects camera shake and increases shutter speed. When **Off** is selected, no icon is displayed.

Notes on Motion Detection

- Motion detection may be unable to completely eliminate the effects of subject movement and camera shake in some situations.
- Motion detection may not function if the subject exhibits significant movement or is too dark.
- The pictures taken using motion detection may be somewhat “grainy” in appearance.

AF Assist

MENU button →  (Setup menu) (📖 126) →  AF assist

Enable or disable AF-assist illumination, which assists autofocus operation when the subject is poorly lit.



Auto (default setting)

AF-assist illumination is used to assist the focus operation when the subject is poorly lit. The illuminator has a range of about 1.9 m (6 ft. 2 in.) at the maximum wide-angle position and about 1.1 m (3 ft. 7 in.) at the maximum telephoto position. Note that for some scene modes, or focus areas, AF-assist illuminator may not light.

Off

AF-assist illuminator does not light. The camera may be unable to focus under dim lighting.

Digital Zoom

MENU button →  (Setup menu) (📖 126) →  Digital zoom

Enable or disable digital zoom.

On (default setting)

When the camera is zoomed in to the maximum optical zoom position, rotating the zoom control to **T** triggers digital zoom (📖 25).



Off

Digital zoom will not be activated (except when recording movies).

Notes on Digital Zoom

- When digital zoom is in effect, **AF area mode** is set to **Center** (📖 44).
- Digital zoom cannot be used in the following situations.
 - When **Scene auto selector**, **Portrait**, or **Night portrait** is selected in scene mode
 - When smart portrait mode is selected
 - When subject tracking mode is selected
 - When **Continuous** is set to **Multi-shot 16** (📖 41)
 - Just before recording a movie (Up to 2x zoom can be activated while recording movies)

Sound Settings

MENU button →  (Setup menu) (📖 126) →  Sound settings

Adjust the following sound settings.

Button sound

Select **On** (default setting) or **Off**.

When **On** is selected, a beep will sound once when operations are completed successfully, twice when the camera acquires focus on the subject, and three times when an error is detected. Start-up sound will also play when the camera is turned on.

Shutter sound

Select **On** (default setting) or **Off**.

No sound is played with shutter release when some features such as continuous shooting or BSS (best shot selector) are enabled, or when recording movies, even if **On** is selected.

Auto Off

MENU button →  (Setup menu) (📖 126) →  Auto off

When the camera is on and a specified period of time passes with no operations performed, the monitor turns off and the camera will enter standby mode (📖 17) to save power. Once the camera has entered standby mode, the power-on lamp will blink, and if no operations are performed for another three minutes, the camera will turn off.

Choose the time allowed to elapse before the camera enters standby mode if no operations are performed from **30 s**, **1 min** (default setting), **5 min**, and **30 min**.

Canceling Standby Mode

Cancel standby mode and reactivate the monitor by pressing any of the following buttons.





- the power switch
- the shutter-release button
- the  button
- the  button

Note on Auto Off

The time allowed to elapse before the camera enters standby mode is fixed in the following situations:

- When a menu is displayed: three minutes
- During slide show playback: up to 30 minutes
- When the AC adapter EH-62D is connected: 30 minutes

Format Memory/ Format Card

MENU button →  (Setup menu) ( 126) →  Format memory/ Format card

Use this option to format the internal memory or a memory card.

Formatting the Internal Memory

To format the internal memory, remove the memory card from the camera.

The **Format memory** option is displayed in the setup menu.

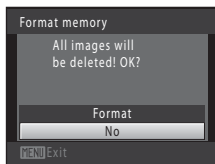

Formatting a Memory Card

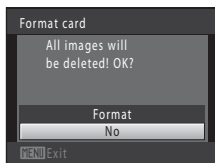

When the memory card is inserted in the camera, the **Format card** option is displayed in the setup menu.



Formatting Internal Memory and Memory Cards

- **Formatting the internal memory or memory cards permanently deletes all data.** Be sure to transfer important pictures to a computer before formatting.
- Formatting the internal memory or memory card restores album icon settings ( 78) to the default setting (displayed as number).
- Do not turn the camera off, or open the battery-chamber/memory card slot cover during formatting.
- Be sure to use this camera to format memory cards previously used in other devices the first time they are inserted into the COOLPIX S205.

Language



MENU button →  (Setup menu) (📖 126) →  Language

Choose one of 24 languages for display of camera menus and messages.

Čeština	Czech
Dansk	Danish
Deutsch	German
English	(default setting)
Español	Spanish
Ελληνικά	Greek
Français	French
Indonesia	Indonesian
Italiano	Italian
Magyar	Hungarian
Nederlands	Dutch
Norsk	Norwegian



Polski	Polish
Português	Portuguese
Русский	Russian
Suomi	Finnish
Svenska	Swedish
Türkçe	Turkish
简体中文	Simplified Chinese
繁體中文	Traditional Chinese
日本語	Japanese
한글	Korean
ภาษาไทย	Thai
عربي	Arabic

Video Mode

MENU button →  (Setup menu) (📖 126) →  Video mode

Adjust settings for connection to a television. Choose from **NTSC** and **PAL**.

Charge by Computer

MENU button →  (Setup menu) →  Charge by computer

Choose whether or not the battery inserted in the camera is charged when the camera is connected to a computer via USB cable ( 117).

Auto (default setting)

When the camera is connected to a computer that is running, the battery inserted into the camera is automatically charged using power supplied by the computer.



Off

The battery inserted into the camera is not charged when the camera is connected to a computer.

Notes on Connecting the Camera to a Printer

- The battery cannot be charged with connection to a printer, even if the printer complies with the PictBridge standard.
- When **Auto** is selected for **Charge by computer**, it may be impossible to print pictures with direct connection of the camera to some printers. If the **PictBridge** startup screen is not displayed in the monitor after the camera is connected to a printer and turned on, turn the camera off and disconnect the USB cable. Set **Charge by computer** to **Off** and reconnect the camera to the printer.

Blink Warning

MENU button →  (Setup menu) (📖 126) →  Blink warning

Specify whether or not the camera detects human subjects that have blinked using face priority when shooting in the following modes.

-  (auto) mode (when **Face priority** (📖 44) is selected for AF area mode option).
- **Scene auto selector** (📖 51), **Portrait** (📖 53), or **Night portrait** (📖 54) is selected for the scene mode.

On

When the camera detects that one or more human subjects may have blinked in a picture taken using face priority, the blink warning screen is displayed in the monitor.

The face of the human subject that may have blinked when the shutter was released is framed by a yellow border. Should this occur, check the picture and determine whether or not another picture should be taken.

See “Operating the Blink Warning Screen” (📖 142) for more information.

Off (default setting)

Blink warning is not enabled.

Note on Blink Warning

The blink warning does not function at continuous settings of **Continuous**, **BSS**, or **Multi-shot 16**.

Operating the Blink Warning Screen

When the blink warning screen shown at right is displayed in the monitor, the operations described below are available.

If no operations are performed within a few seconds, the camera automatically returns to shooting mode.



Option	Use	Description
Enlarge the detected face that blinked	T (Q)	Rotate the zoom control to T (Q).
Switch to full-frame playback	W (checkered flag)	Rotate the zoom control to W (checkered flag).
Select the face to be displayed		If the camera detects that more than one human subject blinked, press ▲, ▼, ◀ or ▶ with display zoomed in to switch to another face.
Delete the picture		Press the button.
Switch to shooting mode		Press the button or the shutter-release button.

Reset All

MENU button →  (Setup menu) (📖 126) →  Reset all

When **Reset** is selected, the camera's settings will be restored to their default values.

Basic Shooting Functions

Option	Default value
Flash mode (📖 30)	Auto
Self-timer (📖 32)	Off
Macro mode (📖 33)	Off
Exposure compensation (📖 34)	0.0

Shooting Menu

Option	Default value
Image mode (📖 37)	 4000×3000
White balance (📖 39)	Auto
Continuous (📖 41)	Single
ISO sensitivity (📖 42)	Auto
Color options (📖 43)	Standard color
AF area mode (📖 44)	Face priority
Autofocus mode (📖 48)	Single AF

Scene Mode

Option	Default value
Scene mode setting in the shooting-mode selection menu (📖 50)	Scene auto selector
Hue adjustment in Food mode (📖 57)	Center

Smart Portrait Menu

Option	Default value
Skin softening (📖 64)	Normal
Smile timer (📖 64)	On
Blink proof (📖 64)	Off

Subject Tracking Menu

Option	Default value
Autofocus mode (📖 67)	Full-time AF

Movie Menu

Option	Default value
Movie options (📖 108)	 TV movie 640
Autofocus mode (📖 109)	Single AF
Electronic VR (📖 109)	Off

Setup Menu

Option	Default value
Menus (📖 127)	Text
Welcome screen (📖 128)	None
Photo info (📖 132)	Auto info
Image review (📖 132)	On
Brightness (📖 132)	3
Date imprint (📖 133)	Off
Electronic VR (📖 134)	Off
Motion detection (📖 135)	Auto
AF assist (📖 136)	Auto
Digital zoom (📖 136)	On
Button sound (📖 137)	On
Shutter sound (📖 137)	On
Auto off (📖 137)	1 min
Charge by computer (📖 140)	Auto
Blink warning (📖 141)	Off

Others

Option	Default value
Paper size (📖 121, 122)	Default
Frame intvl for Slide show (📖 91)	3 s

- Choosing **Reset all** also clears the current file number (📖 151) from memory. Numbering will continue from the lowest number available. To reset file numbering to "0001", delete all pictures (📖 92) before selecting **Reset all**.
- The following menu settings will remain unaffected when menus are reset with **Reset all**.
Shooting menu: Preset manual data (📖 40) acquired for **White balance**
Setup menu: Picture selected for **Welcome screen** (📖 128), **Date** (📖 129), **Language** (📖 139), and **Video mode** (📖 139)

Ver. Firmware Version

MENU button → **Y** (Setup menu) (📖 126) → **Ver.** Firmware version

View the current camera firmware version.

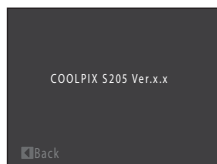

Maximizing Camera Life and Performance

To ensure continued enjoyment of this Nikon product, observe the following precautions when using or storing the device.

Keep dry

The device will be damaged if immersed in water or subjected to high humidity.

Do not drop

The product may malfunction if subjected to strong shock or vibration.

Handle the lens and all moving parts with care

Do not apply force to the lens, lens cover, monitor, memory card slot or battery chamber. These parts are easily damaged. Applying force to the lens cover could result in camera malfunction or damage to the lens. Should the monitor break, care should be taken to avoid injury caused by broken glass and to prevent the liquid crystal from the display touching the skin or entering the eyes or mouth.

Do not point the lens at strong light sources for extended periods

Avoid pointing the lens at the sun or other strong light sources for extended periods when using or storing the camera. Intense light may cause deterioration of the CCD image sensor, producing a white blur effect in photographs.

Keep away from strong magnetic fields

Do not use or store this device in the vicinity of equipment that generates strong electromagnetic radiation or magnetic fields. Strong static charge or the magnetic fields produced by equipment such as radio transmitters could interfere with the monitor, damage data stored on the memory card, or affect the product's internal circuitry.

Avoid sudden changes in temperature

Sudden changes in temperature, such as when entering or leaving a heated building on a cold day, can cause condensation to form inside the device. To prevent condensation, place the device in a carrying case or a plastic bag before exposing it to sudden changes in temperature.

Turn the product off before removing or disconnecting the power source

Do not remove the battery while the product is on, or while images are being recorded or deleted. Forcibly cutting power in these circumstances could result in loss of data or in damage to product memory or internal circuitry.

 **The Battery**

- Check the battery level before using the camera and replace or charge the battery if necessary. Do not continue charging once the battery is fully charged as this will result in reduced battery performance. Whenever possible, carry a fully charged spare battery when taking pictures on important occasions.
- Do not use the battery at ambient temperatures below 0 °C (32 °F) or above 40 °C (104 °F).
- Charge the battery indoors with an ambient temperature of 5 °C to 35 °C (41 °F to 95 °F) before use.
- When charging the COOLPIX S205 using the Charging AC adapter EH-68P or a computer, the battery is not charged at ambient temperatures below 0 °C (32 °F) or above 45 °C (113 °F).
- Note that the battery may become hot during use; wait for the battery to cool before charging. Failure to observe these precautions could damage the battery, impair its performance or prevent it from charging normally.
- On cold days, the capacity of batteries tends to decrease. Be sure that the battery is fully charged before heading outside to take pictures in cold weather. Keep spare batteries in a warm place and exchange as necessary. Once warmed, a cold battery may recover some of its charge.
- Dirt on the battery terminals can prevent the camera from functioning. Should the battery terminals become dirty, wipe them off with a clean, dry cloth before use.
- If the battery will not be used for some time, insert it in the camera and completely exhaust it before removing it for storage. The battery should be stored in a cool location with an ambient temperature of 15 to 25 °C (59 to 77 °F). Do not store the battery in hot or extremely cold locations.
- Always remove the battery from the camera or optional battery charger when it is not being used. When inserted, minute amounts of current flow even when unused, and the battery may become excessively drained and no longer function. Turning the camera on or off while the battery is exhausted can result in reduced battery life.
- Recharge the battery at least once every six months and completely exhaust it before returning it to storage.
- After removing the battery from the camera or optional battery charger, return the battery to the battery case and store in a cool place.
- A marked drop in the time a fully charged battery retains its charge, when used at room temperature, indicates that the battery needs to be replaced. Purchase a new EN-EL10 battery.
- Replace the battery when it no longer holds a charge. Used batteries are a valuable resource. Please recycle used batteries in accordance with local regulations.

Cleaning

Lens	Avoid touching glass parts with your fingers. Remove dust or lint with a blower (typically a small device with a rubber bulb attached to one end that is pumped to produce a stream of air out the other end). To remove fingerprints or other stains that cannot be removed with a blower, wipe the lens with a soft cloth, using a spiral motion that starts at the center of them and working toward the edges. If this fails, clean the lens using a cloth lightly dampened with commercial lens cleaner.
Monitor	Remove dust or lint with a blower. To remove fingerprints and other stains, clean the monitor with a soft, dry cloth, being careful not to apply pressure.
Body	Use a blower to remove dust, dirt or sand, then wipe gently with a soft, dry cloth. After using the camera at the beach or other sandy or dusty environment, wipe off any sand, dust or salt with a dry cloth lightly dampened with fresh water and dry thoroughly. Note that foreign matter inside the camera could cause damage not covered by the warranty.

Do not use alcohol, thinner, or other volatile chemicals.

Storage

Turn the camera off when not in use. Be sure that the power-on lamp is off before putting the camera away. Remove the battery if the camera will not be used for an extended period. Do not store the camera with naphtha or camphor moth balls, or in any of the following locations:

- Next to equipment that produces strong electromagnetic fields, such as televisions or radios
- Exposed to temperatures below -10°C (14°F) or above 50°C (122°F)
- Places that are poorly ventilated or subject to humidity of over 60%

To prevent mold or mildew, take the camera out of storage at least once a month. Turn the camera on and release the shutter a few times before putting the camera away again.

Notes on the Monitor

- The monitor may contain a few pixels that are always lit or that do not light. This is a characteristic common to all TFT LCD displays, and does not indicate a malfunction. Images recorded using the product will not be affected.
- White or colored streaks may be visible when bright subjects are framed in the monitor. This phenomenon, known as “smear,” occurs when extremely bright light strikes the image sensor; it is characteristic of image sensors and does not indicate a malfunction. Smear may also take the form of partial discoloration in the monitor during shooting. It does not appear in images recorded with the camera except in the cases of movies and of images recorded with **Multi-shot 16** selected for **Continuous**. When shooting in these modes, we recommend that you avoid bright subjects such as the sun, reflected sunlight, and electric lights.
- Images in the monitor may be difficult to see under bright lighting.
- The monitor is lit by an LED backlight. Should the monitor begin to dim or flicker, contact your Nikon-authorized service representative.

Optional Accessories

Rechargeable battery	Rechargeable Li-ion Battery EN-EL10
Charging AC Adapter	Charging AC Adapter EH-68P*, EH-68P (AR)*
Battery charger	Battery Charger MH-63
AC adapter	<p>AC Adapter EH-62D</p> <p><Connecting the EH-62D></p> <p>1 2 3</p> <p>Check that the AC adapter cord has been inserted correctly into the battery chamber before closing the battery-chamber/ memory card slot cover. If part of the cord has not been inserted into the chamber the cover may be damaged during closure.</p>
USB cable	USB Cable UC-E6
Audio/Video cable	Audio Video Cable EG-CP14

* When using in other countries, use a third-party plug adapter as necessary. For more information about plug adapters, consult your travel agency.

Approved Memory Cards

The following Secure Digital (SD) memory cards have been tested and approved for use in this camera.

All cards of the designated make and capacity can be used, regardless of speed.

	SD memory card	SDHC memory card ²
SanDisk	2 GB ¹	4 GB, 8 GB, 16 GB, 32 GB
TOSHIBA	2 GB ¹	4 GB, 8 GB, 16 GB, 32 GB
Panasonic	2 GB ¹	4 GB, 8 GB, 12 GB, 16 GB, 32 GB
Lexar	2 GB ¹	4 GB, 8 GB

¹ If the memory card will be used with a card reader or similar device, check that device supports 2 GB cards.

²  SDHC-compliant. If the memory card will be used with a card reader or similar device, check that device supports SDHC.

Contact the manufacturer for details on the above cards.

Image/Sound File and Folder Names



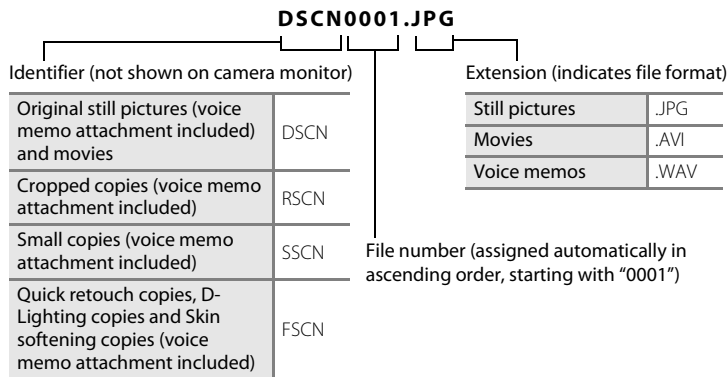







Pictures, movies or voice memos are assigned file names as follows.









- Files are stored in folders named with a folder number followed by a five-character identifier: "P_" plus a three-digit sequential number for pictures taken in **Panorama assist** scene mode (e.g. "101P_001"; 📖 60) and "NIKON" for all other pictures (e.g. "100NIKON"). When the number of files within a folder reaches 9999, a new folder will be created. File numbers will be assigned automatically starting with "0001."
- Voice memo file names have the same identifier and file number as the picture to which the voice memo is attached.
- Files copied using **Copy>Selected images** are copied to the current folder, where they are assigned new file numbers in ascending order starting from the largest file number in memory. **Copy>All images** copies all folders from the source medium; file names do not change but new folder numbers are assigned in ascending order, starting from the largest folder number on the destination medium (📖 97).
- A single folder can hold up to 200 pictures; if the current folder already contains 200 pictures, a new folder, named by adding one to the current folder name, will be created the next time a picture is taken. If the current folder is numbered 999 and contains 200 pictures, or a picture is numbered 9999, no further pictures can be taken until the internal memory or memory card is formatted (📖 138), or a new memory card is inserted.







Error Messages















The following table lists the error messages and other warnings displayed in the monitor, as well as the solutions for dealing with them.

Display	Problem	Solution	
 (blinks)	Clock not set.	Set date and time.	129
	Battery running low.	Prepare to charge or replace battery.	12, 14
 Battery exhausted.	Battery exhausted.	Charge or replace battery.	12, 14
 Battery temperature high	Battery temperature is high.	Turn off camera, and allow battery to cool down before resuming use. After five seconds, this message will disappear, the monitor will turn off, and the power-on lamp and flash lamp will blink rapidly. After the lamps blink for three minutes, the camera will turn off automatically. Pressing the power switch also turns off the camera.	17
 ● (● blinks red)	Camera cannot focus.	<ul style="list-style-type: none"> • Refocus. • Use focus lock. 	26, 27 45
 Please wait for the camera to finish recording.	Camera cannot perform other operations until recording is complete.	Wait until message clears from display automatically when recording is complete.	–
 Memory card is write protected.	Write-protect switch is in “lock” position.	Slide write-protect switch to “write” position.	21
 This card cannot be used.	Error accessing memory card.	<ul style="list-style-type: none"> • Use approved card. • Check that connectors are clean. • Confirm that memory card is correctly inserted. 	150 20
 This card cannot be read.			20









Display	Problem	Solution	
<p> Card is not formatted. Format card? No Yes</p>	Memory card has not been formatted for use in this camera.	Formatting deletes all data stored on the memory card. Be sure to select No and make copies of any pictures you wish to keep before formatting the memory card. Select Yes and press the  button to format the memory card.	21
<p> Out of memory.</p>	Memory card is full.	<ul style="list-style-type: none"> • Choose smaller image size. • Delete pictures. • Insert new memory card. • Remove memory card and use internal memory. 	37 28, 92, 110 20 20
<p> Image cannot be saved.</p>	Error occurred while recording picture.	Format internal memory or memory card.	138
	Camera has run out of file numbers.	Insert a new memory card or format internal memory or memory card.	151
	Picture cannot be used for welcome screen.	<p>The following pictures cannot be stored.</p> <ul style="list-style-type: none"> • Pictures taken at an Image mode setting of  3968 x 2232 • Pictures reduced to 320 x 240 size or smaller with cropping or small picture editing 	128
	Insufficient space to save a copy.	Delete pictures from destination.	92
<p> Album is full. No further pictures can be added.</p>	Over 200 pictures have already been added to album.	<ul style="list-style-type: none"> • Remove some pictures from album. • Add to other albums. 	76 74

Error Messages

Display	Problem	Solution	
 Sound file cannot be saved.	A voice memo cannot be attached to this file.	<ul style="list-style-type: none"> Voice memos cannot be attached to movies. Select a picture taken with this camera. 	– 96
 A blink was detected in the picture just taken.	One or more portrait subjects may have blinked when the picture was taken.	Check the picture in playback mode.	64
 Image cannot be modified.	Cannot edit selected picture.	<ul style="list-style-type: none"> Be sure that the picture meets editing requirements. Movies cannot be edited. 	98 –
 Cannot record movie.	Time out error while recording movie.	Choose memory card with faster write speed.	20
 Memory contains no images.	No pictures in the internal memory or memory card.	<ul style="list-style-type: none"> To play back pictures stored in internal memory, remove memory card from the camera. To copy picture from internal memory to memory card, press the MENU button. The copy screen will be displayed and pictures in the internal memory can be copied to memory card. 	20 97
	The picture has not been added to album.	<ul style="list-style-type: none"> Add the picture to album. Choose the album that the picture was added. 	74 75
	No pictures are contained in the category selected in auto sort mode.	Select the category containing the sorted pictures.	81

Display	Problem	Solution	
 File contains no image data.	File not created with this camera.	File cannot be viewed on this camera. View file using a computer or the devices used to create or edit this file.	–
 This file cannot be played back.			
 All images are hidden.	No pictures available for a slide show.	–	91
 This image cannot be deleted.	Picture is protected.	Disable protection.	92
 Travel destination is in the current time zone.	Destination in same time zone as home.	–	129
Lens error 	Lens error.	Turn camera off and then on again. If error persists, contact retailer or Nikon-authorized service representative.	22
 Communications error	USB cable disconnected during data transfer to printer.	Turn camera off and reconnect cable.	120
System error 	Error has occurred in camera's internal circuitry.	Turn camera off, remove and reinsert battery, and turn camera on. If error persists, contact retailer or Nikon-authorized service representative.	13
 Printer error: check printer status.	Printer error.	Check printer. After solving the problem, select Resume and press the  button to resume printing.*	–
 Printer error: check paper	Specified size of paper is not loaded in printer.	Load the specified paper, select Resume and press the  button to resume printing.*	–
 Printer error: paper jam	Paper has jammed in the printer.	Remove the jammed paper, select Resume and press the  button to resume printing.*	–

Error Messages



Display	Problem	Solution	
 Printer error: out of paper	No paper is loaded in printer.	Load the specified paper, select Resume and press the  button to resume printing.*	–
 Printer error: check ink	Ink error.	Check ink, select Resume and press the  button to resume printing.*	–
 Printer error: out of ink	Running out of ink or ink cartridge is empty.	Replace ink cartridge, select Resume and press the  button to resume printing.*	–
 Printer error: file corrupt	An error caused by the image file has occurred.	Select Cancel and press the  button to cancel printing.	–

* See the documentation provided with your printer for further guidance and information.

Troubleshooting

If the camera fails to function as expected, check the list of common problems below before consulting your retailer or Nikon-authorized service representative.

Display, Settings and Power Supply

Problem	Cause/Solution	
Monitor is blank.	• Camera is off.	17
	• Battery is exhausted.	12
	• Standby mode for saving power: press the power switch, the shutter-release button, the  button, or the  button.	137
	• When flash lamp blinks red, wait until flash has charged.	31
	• Camera and computer are connected via USB cable.	112
	• Camera and TV are connected via A/V cable.	111
Monitor is hard to read.	• Adjust monitor brightness.	132
	• Monitor is dirty. Clean monitor.	146
Camera turns off without warning.	• Battery is exhausted.	22
	• Camera has turned off automatically to save power.	137
	• Battery is cold.	147
	• The camera turns off if the Charging AC Adapter is connected while the camera is on.	14
	• The camera turns off if the USB cable connecting it to a computer or printer is disconnected. Reconnect the USB cable.	113, 115, 120
Date and time of recording are not correct.	• If camera clock has not been set, "Date not set" indicator blinks with shooting and movie recording. Pictures and movies recorded before clock is set are dated "00/00/0000 00:00" or "01/01/2010 00:00" respectively. Set the correct time and date from the Date option in the setup menu.	18, 129
	• Check camera clock regularly against more accurate timepieces and reset as required.	129
No indicators displayed in monitor.	Hide info is selected for Photo info . Select Show info .	132
Date imprint not available.	Camera clock has not been set.	18, 129



Troubleshooting



Problem	Cause/Solution	
Date not appearing on pictures even when Date imprint is enabled.	The current shooting mode is one that does not support Date imprint .	133
Camera settings reset.	Clock battery is exhausted; all settings were restored to their default values.	130
Monitor turns off, and the power-on lamp blinks rapidly.	Battery temperature is high. Turn off camera and allow battery to cool down before resuming use. After the lamp blinks for three minutes, the camera will turn off automatically. Pressing the power switch also turns off the camera.	17
Battery inserted into the camera is not charged when the camera is connected to a computer.	<ul style="list-style-type: none">• The battery is not charged when the camera is turned off.• Charging stops if the computer enters sleep mode while the battery is charging. The camera may be turned off.• Depending upon computer specifications, settings, and status, it may be impossible to charge the battery inserted into the camera via computer connection.	117

Electronically Controlled Cameras





In extremely rare instances, unusual characters may appear in the monitor and the camera may stop functioning. In most cases, this phenomenon is caused by a strong external static charge. Turn the camera off, remove and replace the battery, then turn the camera on again. In the event of continued malfunction, contact your retailer or Nikon-authorized service representative. Note that disconnecting the power source as described above may result in the loss of any data not recorded to internal memory or the memory card at the time the problem occurred. Data already recorded will not be affected.



Shooting

Problem	Cause/Solution	
No picture taken when shutter-release button is pressed.	• When camera is in playback mode, press the  button or the shutter-release button.	8, 28
	• When menus are displayed, press the MENU button.	10
	• Battery is exhausted.	22
	• When flash lamp blinks, flash is charging.	31



Problem	Cause/Solution	
Camera cannot focus.	<ul style="list-style-type: none"> • The intended subject is one with which autofocus does not perform well. • Select Auto for AF assist in set up menu. • Turn camera off and then on again. 	27 136 17
Pictures are blurred.	<ul style="list-style-type: none"> • Use flash. • Increase the ISO sensitivity value. • Enable electronic vibration reduction or motion detection. • Use BSS. • Use tripod and self-timer. 	30 42 134, 135 41 32
Bright specks appear in pictures taken with flash.	Flash is reflecting off particles in air. Turn flash off.	31
Streaks of light or partial discoloration are visible in the monitor.	Smear occurs when extremely bright light strikes the image sensor. When shooting with Continuous set to Multi-shot 16 and when recording movies, avoiding bright objects, such as the sun, reflections of the sun, and electric lights is recommended.	41, 148
Flash does not fire.	<ul style="list-style-type: none"> • Flash is off. • Some scene modes with which the flash does not function is selected. • On is selected for Blink proof in smart portrait menu. •  mode is selected. • Another function that restricts flash is enabled. 	30 53 64 106 49
Optical zoom cannot be used.	Optical zoom cannot be used while recording movies.	107
Digital zoom cannot be used.	<ul style="list-style-type: none"> • Digital zoom is set to Off in the setup menu. Digital zoom is not available in the following situations. • When Scene auto selector, Portrait, or Night portrait is selected for scene mode. • When shooting in smart portrait mode. • When shooting in subject tracking mode. • Just before recording a movie (up to 2x can be applied while recording movies). • When Continuous is set to Multi-shot 16. 	136 51, 53, 54 62 65 106 41
Image mode not available.	Another function that restricts the Image mode option is enabled.	49

Troubleshooting

Problem	Cause/Solution	
Skin tones are not softened.	<ul style="list-style-type: none"> Under some shooting conditions, facial skin tones may not be softened. 	103
	<ul style="list-style-type: none"> Use Skin softening in the playback menu for pictures containing more than three faces. 	102
No sound when shutter is released.	<ul style="list-style-type: none"> Off is selected for Sound settings>Shutter sound in setup menu. No sound is heard with some shooting modes and settings, even when On is selected. 	137
	<ul style="list-style-type: none"> The speaker is blocked. Do not cover the speaker. 	5, 24
AF-assist illuminator does not light.	Off is selected for AF assist in the setup menu. AF-assist illuminator may not light depending on the position of the focus area or the current scene mode, even when Auto is selected.	53-59, 136
Pictures appear smeared.	Lens is dirty. Clean lens.	146
Colors are unnatural.	White balance does not match light source.	39
Randomly spaced bright pixels ("noise") appear in image.	Shutter speed is too slow or ISO sensitivity is high as the subject is dark. Noise can be reduced by:	
	<ul style="list-style-type: none"> Using flash. Specifying a lower ISO sensitivity setting. 	30, 42
Pictures are too dark (underexposed).	<ul style="list-style-type: none"> Flash is off. 	30
	<ul style="list-style-type: none"> Flash window is blocked. 	24
	<ul style="list-style-type: none"> Subject is beyond flash range. 	30
	<ul style="list-style-type: none"> Adjust exposure compensation. 	34
	<ul style="list-style-type: none"> Increase ISO sensitivity. Subject is backlit. Select Backlight scene mode or use fill flash. 	42, 30, 58
Pictures are too bright (overexposed).	Adjust exposure compensation.	34
Unexpected results when flash set to  (auto with red-eye reduction).	When taking pictures with  (auto with red-eye reduction) or fill flash with slow sync and red-eye reduction in Night portrait scene mode, In-Camera Red Eye Fix may be applied to areas not affected by red-eye. Use any scene mode other than Night portrait , and change the flash to any setting other than  (auto with red-eye reduction) and try shooting again.	30, 54

Problem	Cause/Solution	
Saving images takes time.	It may take more time to save images in the following situations.	31
	<ul style="list-style-type: none"> When the noise reduction function is in operation When the flash mode is set to  (auto with red-eye reduction) When the skin softening function is applied while shooting 	31
		53, 54, 64

Playback

Problem	Cause/Solution		
File cannot be played back.	<ul style="list-style-type: none"> File or folder was overwritten or renamed by computer or other make of camera. Movies recorded by a camera other than the COOLPIX S205 cannot be played back. 	– 110	
	Cannot zoom in on picture.	Playback zoom cannot be used with movies, small pictures, or pictures that have been cropped to a size of 320 × 240 or smaller.	–
Cannot record or play back voice memos.	<ul style="list-style-type: none"> Voice memos cannot be attached to movies. Voice memos cannot be attached to images taken with other cameras. Voice memos attached to images using another camera cannot be played back on this camera. 	110 96	
	Cannot use quick retouch, D-Lighting, skin softening, small picture, or crop.	<ul style="list-style-type: none"> These options cannot be used with movies. These options cannot be used with pictures taken at an Image mode setting of  3968 × 2232. Select pictures that support quick retouch, D-Lighting, skin softening, small picture, or crop. Camera is unable to edit pictures taken with other cameras. 	110 37 98 98
Pictures not displayed on television.		<ul style="list-style-type: none"> Select correct Video mode. Memory card contains no pictures. Replace the memory card. Remove the memory card to play back pictures from the internal memory. 	139 20
		Album icon restored to default settings, or pictures added to album not displayed in favorite pictures playback.	Data in the memory card may not be played back correctly if overwritten by a computer.

Problem	Cause/Solution	
<p>The recorded pictures are not displayed in auto sort mode.</p>	<ul style="list-style-type: none"> • The desired picture was sorted to a category other than the category currently displayed. • Pictures recorded by a camera other than the COOLPIX S205 and pictures copied using the copy option cannot be displayed in auto sort mode. • Pictures recorded in internal memory or on the memory card may not be played back correctly if overwritten by a computer. • Up to 999 pictures and movie files can be added to each category. If the desired category already contains 999 pictures, new pictures or movies cannot be added. 	<p>80 81, 97 – –</p>
<p>Nikon Transfer does not start when camera is connected.</p>	<ul style="list-style-type: none"> • Camera is off. • Battery is exhausted. • USB cable is not properly connected. • Camera is not recognized by the computer. • Computer is not set to start Nikon Transfer automatically. For more information on Nikon Transfer, refer to help information contained in Nikon Transfer. • Be sure that the computer meets Nikon Transfer system requirements. 	<p>17 22 113 – 116 112</p>
<p>The PictBridge startup screen is not displayed when the camera is connected to a printer.</p>	<p>With some PictBridge-compatible printers, the PictBridge startup screen may not be displayed and it may be impossible to print pictures when Auto is selected for the Charge by computer option in the setup menu. Set the Charge by computer option to Off and reconnect the camera to the printer.</p>	<p>140</p>
<p>Pictures to be printed are not displayed.</p>	<ul style="list-style-type: none"> • Memory card contains no pictures. Replace the memory card. • Remove the memory card to print pictures from the internal memory. 	<p>20</p>
<p>Cannot select paper size with camera.</p>	<p>Paper size cannot be selected from the camera if the printer does not support the paper sizes used by the camera, or the printer automatically selects the paper size. Use the printer to select paper size.</p>	<p>121, 122</p>

Specifications

Nikon COOLPIX S205 Digital Camera

Type	Compact digital camera
Effective pixels	12.0 million
Image sensor	¹ /2.3-in. type CCD; total pixels: approx. 12.39 million
Lens	4x optical zoom, NIKKOR lens
Focal length	4.9–19.6mm (angle of view equivalent to that of 27–108 mm lens in 35mm [135] format)
f/-number	f/3.2–5.9
Construction	6 elements in 5 groups
Digital zoom	Up to 4x (angle of view equivalent to that of approx. 432 mm lens in 35mm [135] format)
Vibration reduction	Electronic VR
Autofocus (AF)	Contrast-detect AF
Focus range (from lens)	<ul style="list-style-type: none">• Approx. 50 cm (1 ft. 8 in.) to ∞• Macro mode: Approx. 8 cm (3.2 in.) to ∞ (wide-angle position)
Focus-area selection	Auto (9-area automatic selection), center, manual with 99 focus areas, face priority
Monitor	6.7 cm (2.7-in.), approx. 230k-dot, TFT LCD and 5-level brightness adjustment
Frame coverage (shooting mode)	Approx. 97% horizontal and 97% vertical (Compared to actual picture)
Frame coverage (playback mode)	Approx. 100% horizontal and 100% vertical (Compared to actual picture)
Storage	
Media	<ul style="list-style-type: none">• Internal memory (approx. 47 MB)• SD/SDHC memory card
File system	DCF, Exif 2.2, and DPOF compliant
File formats	Still pictures: JPEG Sound files (Voice Memo): WAV Movies: AVI (Motion-JPEG compliant)
Image size (pixels)	<ul style="list-style-type: none">• 12M (High) [4000 × 3000★]• 12M [4000 × 3000]• 8M [3264 × 2448]• 5M [2592 × 1944]• 3M [2048 × 1536]• PC [1024 × 768]• VGA [640 × 480]• 16:9 [3968 × 2232]
ISO sensitivity (Standard output sensitivity)	<ul style="list-style-type: none">• ISO 80, 100, 200, 400, 800, 1600, 3200• Auto (auto gain from ISO 80 to 1600)• Fixed range auto (ISO 80-400, ISO 80-800)

Specifications

Exposure	
Metering	256-segment matrix, center-weighted (digital zoom less than 2x), spot (digital zoom 2x or more)
Exposure control	Programmed auto exposure with motion detection and exposure compensation (-2.0 to +2.0 EV in steps of 1/3 EV)
Range (📷 auto mode)	[W]: -0.6 to +17.2 EV [T]: 1.2 to 19.0 EV (exposure values achieved with automatic ISO sensitivity adjustment converted to ISO 100 values)
Shutter	
Speed	1/2000 -1 s (when ISO sensitivity is set to Auto) 1/2000 -1 s (when ISO sensitivity is fixed at a specific value) 4 s (when scene mode is set to Fireworks show)
Aperture	
Range	2 steps (f/3.2 and f/8 [W])
Self-timer	Can be selected from 10 and 2 second duration
Built-in flash	
Range (approx.) (ISO sensitivity: Auto)	[W]: 0.5 to 4.5 m (1 ft. 8 in. to 14 ft.) [T]: 0.5 to 2.4 m (1 ft. 8 in. to 7 ft. 10 in.)
Flash control	TTL auto flash with monitor preflashes
Interface	
Data Transfer Protocol	MTP, PTP
Video output	Can be selected from NTSC and PAL
I/O terminal	Audio video output/digital I/O (USB)
Supported languages	Arabic, Chinese (Simplified and Traditional), Czech, Danish, Dutch, English, Finnish, French, Greek, German, Hungarian, Indonesian, Italian, Japanese, Korean, Polish, Portuguese, Norwegian, Russian, Spanish, Swedish, Thai, Turkish
Power sources	One EN-EL10 Rechargeable Li-ion Battery (supplied) AC Adapter EH-62D (available separately)
Charging time	Approx. 2 hours and 10 minutes (when using Charging AC Adapter EH-68P/EH-68P (AR) and when no charge remains)
Battery life (EN-EL10)	Still pictures*: Approx. 220 shots Movies: Approx. 1 h 30 min (TV movie 640)
Dimensions (W × H × D)	Approx. 94.3 × 55.9 × 19.0 mm (3.8 × 2.2 × 0.8 in.) (excluding projections)
Weight	Approx. 117 g (4.1 oz.) (with battery and SD memory card)
Operating environment	
Temperature	0 to 40 °C (32 to 104 °F)
Humidity	Less than 85% (no condensation)

- Unless otherwise stated, all figures are for a camera with a fully-charged Rechargeable Li-ion Battery EN-EL10 operated at an ambient temperature of 25 °C (77 °F).
- * Based on Camera and Imaging Products Association (CIPA) standards for measuring the life of camera batteries. Measured at 23 °C (73 °F); zoom adjusted with each shot, flash fired with every other shot, image mode set to **24 4000×3000**. Battery life may vary depending on shooting interval and length of time menus and images are displayed.

Rechargeable Li-ion Battery EN-EL10

Type	Rechargeable lithium-ion battery
Rated capacity	DC 3.7 V, 740 mAh
Operating temperature	0 to 40 °C (32 to 104 °F)
Dimensions (W × H × D)	Approx. 31.5 × 39.5 × 6 mm (1.2 × 1.6 × 0.2 in.) (excluding projections)
Weight	Approx. 15 g (0.5 oz) (excluding battery case)

Charging AC Adapter EH-68P/EH-68P (AR)

Rated input	AC 100-240 V, 50/60 Hz, 0.065-0.04 A
Rated capacity	6.5-9.6 VA
Rated output	DC 5.0 V, 0.5 A
Operating temperature	0 to 40 °C (32 to 104 °F)
Dimensions (W × H × D)	EH-68P: Approx. 55 × 22 × 65 mm (2.7 × 0.9 × 2.6 in.) EH-68P (AR): Approx. 55 × 51.6 × 66 mm (2.2 × 2.0 × 2.6 in.)
Weight	EH-68P: Approx. 60 g (2.1 oz) EH-68P (AR): Approx. 65 g (2.3 oz)

Specifications





















Nikon will not be held liable for any errors this manual may contain. The appearance of this product and its specifications are subject to change without notice.





Supported Standards

- **DCF:** Design Rule for Camera File System is a standard widely used in the digital camera industry to ensure compatibility among different makes of camera.
- **DPOF:** Digital Print Order Format is an industry-wide standard that allows pictures to be printed from print orders stored on memory cards.
- **Exif version 2.2:** This camera supports Exchangeable image file format (Exif) version 2.2 for digital still cameras, a standard that allows information stored with photographs to be used for optimal color reproduction when images are output from Exif-compliant printers.
- **PictBridge:** A standard developed cooperatively by the digital camera and printer industries, allowing photographs to be output directly to a printer without connecting the camera to a computer.

Index

Symbols

-  Auto mode 22
-  Scene mode 50
-  Smart portrait mode 62
-  Subject tracking mode 65
-  Movie mode 106
-  Setup menu 125
-  Favorite pictures mode 74
-  Auto sort mode 80
-  List by date mode 83
- T** (Tele) 4, 25
- W** (Wide) 4, 25
-  Playback zoom 4, 72
-  Thumbnail playback 4, 69
-  Help 4, 11
-  Apply selection button 5, 9
-  Delete button 5, 28, 29, 96, 110
-  Playback mode 5, 8, 28
-  Self timer 32
-  Flash mode 30
-  Macro mode 33
- MENU** Menu button 5
-  (Shooting mode) button 5, 8
-  Exposure compensation 34
- AE/AF-L** 61
- A**
- A/V cable 111
- AC adapter 149
- AF area 26
- AF area mode 44
- AF assist 136
- Aperture 26
- Audio-in/Video-in jack 111
- Auto flash 30
- Auto mode 22
- Auto off 137
- Auto sort menu 82
- Auto sort mode 80
- Autofocus 33
- Autofocus mode 48, 67, 109

- AVI 151
- B**
- Backlight  58
- Battery 12, 14, 130
- Battery chamber 5
- Battery charger 149
- Battery latch 5
- Battery level 22
- Battery-chamber/memory card slot cover 5, 12, 20
- Beach/snow  55
- Best Shot Selector 41
- Black-and-white 43
- Blink proof 64
- Blink warning 141
- Brightness 132
- BSS 41
- Built-in flash 4, 30
- Built-in microphone 4, 95
- Button sound 137
- C**
- Calendar display 71
- Charge by computer 140
- Charging AC adapter 14, 149
- Close-up  56
- Cloudy 39
- Color options 43
- Compression ratio 37
- Computer 112, 112–115
 - copying pictures to 112–115
- Connector cover 5
- Continuous 41
- Copy  58
- Copying pictures 97
- Crop 105
- Cyanotype 43
- D**
- Date 18, 129
- Date imprint 133
- Daylight 39

Daylight saving time 18, 130

Delete 92

Digital zoom 25, 136

Direct print 119

D-Lighting 101

DPOF print 124

DSCN 151

Dusk/dawn  55

E

EH-68P 14, 149

Electronic VR (movie) 109

Electronic VR (still pictures) 134

EN-EL10 12, 14

Exposure compensation 34

Extension 151

Eyelet for camera strap 4

E

Face priority 44, 46

Favorite pictures menu 77

Favorite pictures mode 77

File names 151

Fill flash 30

Fireworks show  58

Firmware version 145

Fixed range auto 42

Flash 30, 31

Flash lamp 5, 31

Flash mode 30, 31

Flash off 30

Fluorescent 39

Focus 26, 44

Focus lock 45

Folder name 151

Food  57

Format 21, 138

Format memory card 21, 138

Formatting internal memory 138

FSCN 151

Full-frame playback 28, 29

Full-time AF 48, 109

H

Halfway 11

Help 11

I

Identifier 151

Image mode 23, 37, 50, 64, 66

Image review 132

Image size 37

Incandescent 39

Internal memory 20

Internal memory indicator 23

ISO sensitivity 31, 42

J

JPG 151

L

Landscape  53

Language 139

Lens 4, 163

List by date menu 85

List by date mode 83

Lithium-ion type battery 14

M

Macro mode 33

Memory capacity 22

Memory card 20, 150

Memory card slot 5, 20

Menus 127

Monitor 5, 6, 148

Monitor settings 132

Motion detection 135

Movie menu 108

Movie options 108

Movie playback 110

Movie recording 106

Multi selector 5, 9

Multi-shot 16 41

Museum  57

N

Night landscape  56

Night portrait  54

Nikon Transfer 112
 Number of exposures remaining 22, 38

O

Optional accessories 149

P

Panorama assist  59, 60

Panorama Maker 112, 116

Paper size 121, 122

Party/indoor  55

Photo info 132

PictBridge 119, 166

Playback 28, 29, 69, 72

Playback menu 86

Playback zoom 72

Portrait  53

Power 18, 22

Power switch 4, 22

Power-on lamp 4, 22

Preset manual 40

Print 87, 121, 122

Print set 87

Print Set (Date) 88

Printer 119

Protect 94

Q

Quick retouch 100

R

Rechargeable battery 149

Rechargeable Li-ion battery 12

Recording movies 106

Red-eye reduction 30, 31

Reset all 143

Rotate image 94

RSCN 151

S

Scene auto selector  51

Scene mode 50, 53

Self-timer 32

Self-timer lamp 4, 32

Sepia 43

Setup menu 125

Shooting 22, 24, 26

Shooting menu 36

Shutter sound 137

Shutter speed 26

Shutter-release button 4, 26

Single 41

Single AF 48, 109

Skin softening 64, 102

Slide show 91

Slow sync 30

Small picture 104

Smart portrait menu 64

Smile timer 64

Software Suite 112

Sound settings 137

Speaker 5

Sports  54

SSCN 151

Standard color 43

Strap 11

Subject tracking menu 67

Subject tracking mode 65

Sunset  55

T

Thumbnail playback 69

Time zone 129, 131

Tripod socket 5

TV 111

TV movie 108

U

USB cable 112, 113, 120

V

Video mode 139

ViewNX 112, 115

Vivid color 43

Voice memo 95

Volume 110

W

WAV 151

Index

Welcome screen 128

White balance 39

Z

Zoom control 4, 25, 110

Nikon

No reproduction in any form of this manual, in whole or in part (except for brief quotation in critical articles or reviews), may be made without written authorization from NIKON CORPORATION.

NIKON CORPORATION

© 2010 Nikon Corporation

YPOF01(11)
6MM87511-01