

**Nikon**

DIGITAL CAMERA

# COOLPIX P520

## Reference Manual

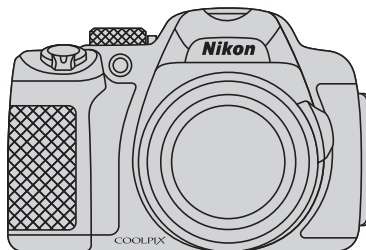

En



## COOLPIX P520 Recommended Features



### **Vibration Reduction** ..... **104**

You can set the vibration reduction effect to either **Normal** or **Active**. When you select **Active**, a comparatively large camera shake is compensated for when shooting from a car or under poor foothold conditions.

### **Movie** ..... **92**

You can record movies by simply pressing the  (  movie-record) button. You can change the color tones of a movie in accordance with the shooting mode and white balance settings. You can also record slow motion and fast motion movies.

### **GPS Function**..... **98**

You can record position information (latitude and longitude) on the pictures to be shot using the camera's internal GPS unit.

### **Compatible with Wireless Mobile Adapter (Available Separately)**

You can attach the optional Wireless Mobile Adapter WU-1a to a USB/Audio video connector. You can connect the camera via Wi-Fi (wireless LAN) connection to smart devices that have the dedicated software installed.

See our websites, product catalog, or the instruction manual of the WU-1a for further details.

**Introduction**

**Parts of the Camera and Main Functions**

**The Basics of Shooting and Playback**

**Shooting Features**

**Playback Features**

**Recording and Playing Back Movies**

**Using GPS**

**General Camera Setup**

**Reference Section**

**Technical Notes and Index**

# Introduction

## Read This First

Thank you for purchasing the Nikon COOLPIX P520 digital camera.

Before using the camera, please read the information in “For Your Safety” (📖 vi to viii) and familiarize yourself with the information provided in this manual. After reading, please keep this manual handy and refer to it to enhance your enjoyment of your new camera.

## About This Manual







If you want to start using the camera right away, see “The Basics of Shooting and Playback” (📖16).

See “Parts of the Camera and Main Functions” (📖1) for more information on the names and principle functions of the camera parts.

### Other Information

- Symbols and Conventions

To make it easier to find the information you need, the following symbols and conventions are used in this manual:

Icon	Description
	This icon indicates cautions and information that should be read before using the camera.
	This icon marks notes, information that should be read before using the camera.
  	These icons indicate other pages containing relevant information;  : “Reference Section,”  : “Technical Notes and Index.”

- SD, SDHC and SDXC memory cards are referred to as “memory cards” in this manual.
- The setting at the time of purchase is referred to as the “default setting.”
- The names of menu items displayed in the monitor screen, and the names of buttons or messages displayed on a computer monitor appear in bold.
- In this manual, images are sometimes omitted from monitor screen samples so that monitor indicators can be more clearly shown.
- The illustrations of monitor content and camera may differ from the actual product.

## Information and Precautions

### Life-Long Learning

As part of Nikon's "Life-Long Learning" commitment to ongoing product support and education, continually updated information is available online at the following sites:

- For users in the U.S.A.: <http://www.nikonusa.com/>
- For users in Europe and Africa: <http://www.europe-nikon.com/support/>
- For users in Asia, Oceania, and the Middle East: <http://www.nikon-asia.com/>

Visit these sites to keep up-to-date with the latest product information, tips, answers to frequently asked questions (FAQs), and general advice on digital imaging and photography. Additional information may be available from the Nikon representative in your area. Visit the site below for contact information:

<http://imaging.nikon.com/>

### Use Only Nikon Brand Electronic Accessories

Nikon COOLPIX cameras are designed to the highest standards and include complex electronic circuitry. Only Nikon brand electronic accessories (including battery chargers, batteries, Charging AC Adapter and AC adapters) certified by Nikon specifically for use with this Nikon digital camera are engineered and proven to operate within the operational and safety requirements of this electronic circuitry.

THE USE OF NON-NIKON ELECTRONIC ACCESSORIES COULD DAMAGE THE CAMERA AND MAY VOID YOUR NIKON WARRANTY.

The use of third-party rechargeable Li-ion batteries not bearing the Nikon holographic seal could interfere with normal operation of the camera or result in the batteries overheating, igniting, rupturing, or leaking.

For more information about Nikon brand accessories, contact a local authorized Nikon dealer.

**Holographic seal:** Identifies this device as an authentic Nikon product.



### Before Taking Important Pictures

Before taking pictures on important occasions (such as at weddings or before taking the camera on a trip), take a test shot to ensure that the camera is functioning normally. Nikon will not be held liable for damages or lost profits that may result from product malfunction.

### About the Manuals

- No part of the manuals included with this product may be reproduced, transmitted, transcribed, stored in a retrieval system, or translated into any language in any form, by any means, without Nikon's prior written permission.
- Nikon will not be held liable for any damages resulting from the use of this product.
- Nikon reserves the right to change the specifications of the hardware and software described in the documentation at any time and without prior notice.
- While every effort was made to ensure that the information in the documentation is accurate and complete, we would appreciate it were you to bring any errors or omissions to the attention of the Nikon representative in your area (address provided separately).

## Notice Concerning Prohibition of Copying or Reproduction

Note that simply being in possession of material that was digitally copied or reproduced by means of a scanner, digital camera or other device may be punishable by law.

### • Items prohibited by law from being copied or reproduced

Do not copy or reproduce paper money, coins, securities, government bonds or local government bonds, even if such copies or reproductions are stamped "Sample." The copying or reproduction of paper money, coins, or securities which are circulated in a foreign country is prohibited. Unless the prior permission of the government was obtained, the copying or reproduction of unused postage stamps or post cards issued by the government is prohibited.

The copying or reproduction of stamps issued by the government and of certified documents stipulated by law is prohibited.

### • Cautions on certain copies and reproductions

The government has issued cautions on copies or reproductions of securities issued by private companies (shares, bills, checks, gift certificates, etc.), commuter passes, or coupon tickets, except when a minimum of necessary copies are to be provided for business use by a company. Also, do not copy or reproduce passports issued by the government, licenses issued by public agencies and private groups, ID cards and tickets, such as passes and meal coupons.

### • Comply with copyright notices

The copying or reproduction of copyrighted creative works such as books, music, paintings, woodcut prints, maps, drawings, movies, and photographs is governed by national and international copyright laws. Do not use this product for the purpose of making illegal copies or to infringe copyright laws.

## Disposing of Data Storage Devices

Please note that deleting images or formatting data storage devices such as memory cards or built-in camera memory does not completely erase the original image data. Deleted files can sometimes be recovered from discarded storage devices using commercially available software, potentially resulting in the malicious use of personal image data. Ensuring the privacy of such data is the user's responsibility.

Before discarding a data storage device or transferring ownership to another person, erase all data using commercial deletion software, or set the **Record GPS data** of the **GPS options** (☰98) to **Off** after formatting the device and then take pictures such as the empty sky or ground surface until the storage device becomes full. Be sure to also replace any pictures selected for the **Select an image** option in the **Welcome screen** setting (☰103). Care should be taken to avoid injury or damage to property when physically destroying data storage devices.

For the COOLPIX P520, the log data saved on the memory card is handled in the same way as other data. To erase the log data that is obtained but not stored on the memory card, select **Create log** (☰102) → **End log** → **Erase log**.

## For Your Safety

To prevent damage to your Nikon product or injury to yourself or to others, read the following safety precautions in their entirety before using this equipment. Keep these safety instructions where all those who use the product will read them.



This icon marks warnings, information that should be read before using this Nikon product, to prevent possible injury.

### WARNINGS

#### **Turn off in the event of malfunction**

Should you notice smoke or an unusual smell coming from the camera or Charging AC Adapter, unplug the Charging AC Adapter and remove the battery immediately, taking care to avoid burns. Continued operation could result in injury. After removing or disconnecting the power source, take the equipment to a Nikon-authorized service representative for inspection.

#### **Do not disassemble**

Touching the internal parts of the camera or Charging AC Adapter could result in injury. Repairs should be performed only by qualified technicians. Should the camera or Charging AC Adapter break open as the result of a fall or other accident, take the product to a Nikon-authorized service representative for inspection, after unplugging the product and/or removing the battery.

#### **Do not use the camera or Charging AC Adapter in the presence of flammable gas**

Using the camera in the presence of flammable gases such as propane and gasoline, as well as flammable sprays or dust could result in explosion or fire.

#### **Handle the camera strap with care**

Never place the strap around the neck of an infant or child.

#### **Keep out of reach of children**

Do not keep the products within reach of children. Doing so may cause injury. Particular care should be taken to prevent infants from putting the battery or other small parts into their mouths.

#### **Do not remain in contact with the camera, Charging AC Adapter, or AC adapter for extended periods while the devices are on or in use.**

Parts of the devices become hot. Leaving the devices in direct contact with the skin for extended periods may result in low-temperature burns.



### **Observe caution when handling the battery**

The battery may leak, overheat, or explode if improperly handled. Observe the following precautions when handling the battery for use in this product:

- Before replacing the battery, turn the product off. If you are using the Charging AC Adapter/AC adapter, be sure it is unplugged.
- Use only a Rechargeable Li-ion Battery EN-EL5 (included). Charge the battery by inserting it into the camera and connecting the Charging AC Adapter EH-69P (included).
- When inserting the battery, do not attempt to insert it upside down or backwards.
- Do not disassemble the battery or attempt to remove or break the battery insulation or casing.
- Do not expose the battery to flame or to excessive heat.
- Do not immerse in or expose to water.
- Replace the terminal cover when transporting the battery. Do not transport or store with metal objects such as necklaces or hairpins.
- The battery is prone to leakage when fully discharged. To avoid damage to the product, be sure to remove the battery when no charge remains.
- Discontinue use immediately should you notice any change in the battery, such as discoloration or deformation.

- If liquid from the damaged battery comes in contact with clothing or skin, rinse immediately with plenty of water.

### **Observe the following precautions when handling the Charging AC Adapter**

- Keep dry. Failure to observe this precaution could result in fire or electric shock.
- Dust on or near the metal parts of the plug should be removed with a dry cloth. Continued use could result in fire.
- Do not handle the plug or go near the Charging AC Adapter during lightning storms. Failure to observe this precaution could result in electric shock.
- Do not damage, modify, forcibly tug or bend the USB cable, place it under heavy objects, or expose it to heat or flames. Should the insulation be damaged and the wires become exposed, take it to a Nikon-authorized service representative for inspection. Failure to observe these precautions could result in fire or electric shock.
- Do not handle the plug or Charging AC Adapter with wet hands. Failure to observe this precaution could result in electric shock.
- Do not use with travel converters or adapters designed to convert from one voltage to another or with DC-to-AC inverters. Failure to observe this precaution could damage the product or cause overheating or fire.

**⚠ Use appropriate cables**

When connecting cables to the input and output jacks, use only the cables provided or sold by Nikon for the purpose, to maintain compliance with product regulations.

**⚠ Handle moving parts with care**

Be careful that your fingers or other objects are not pinched by the lens cover or other moving parts.

**⚠ CD-ROMs**

The CD-ROMs included with this device should not be played back on audio CD equipment. Playing CD-ROMs on an audio CD player could cause hearing loss or damage the equipment.

**⚠ Observe caution when using the flash**

Using the flash close to your subject's eyes could cause temporary visual impairment. Particular care should be observed if photographing infants, when the flash should be no less than 1 m (3 ft 4 in.) from the subject.

**⚠ Do not operate the flash with the flash window touching a person or object**

Failure to observe this precaution could result in burns or fire.

**⚠ Avoid contact with liquid crystal**

Should the monitor break, care should be taken to avoid injury caused by broken glass and to prevent liquid crystal from the monitor touching the skin or entering the eyes or mouth.

**⚠ Turn the power off when using inside an airplane or the hospital**

Turn the power off while inside the airplane during take off or landing. Also, before boarding an airplane, set the GPS tracking information recording function to OFF. Follow the instructions of the hospital when using while in a hospital. The electromagnetic waves emitted by this camera may disrupt the electronic systems of the airplane or the instruments of the hospital. Remove the Eye-Fi card, which can be the cause of the disruption, beforehand if inserted in the camera.

**⚠ 3D Images**

Do not continuously view 3D images recorded with this device for extended periods, whether on a television, monitor, or other display. In the case of children whose visual systems are still maturing, consult a pediatrician or ophthalmologist prior to use and follow their instructions. Prolonged viewing of 3D images may cause eye strain, nausea, or discomfort. Cease use should any of these symptoms occur and consult a physician if necessary.

## Notices

### Notices for Customers in the U.S.A.

#### **IMPORTANT SAFETY INSTRUCTIONS -**

#### **SAVE THESE INSTRUCTIONS.**

#### **DANGER - TO REDUCE THE RISK OF FIRE OR ELECTRIC SHOCK, CAREFULLY FOLLOW THESE INSTRUCTIONS**

For connection to a supply not in the U.S.A., use an attachment plug adapter of the proper configuration for the power outlet if needed.

The power supply unit is intended to be correctly orientated in a vertical or floor mount position.

#### **Federal Communications Commission (FCC) Radio Frequency Interference Statement**

This equipment has been tested and found to comply with the limits for a Class B digital device, pursuant to Part 15 of the FCC rules. These limits are designed to provide reasonable protection against harmful interference in a residential installation. This equipment generates, uses, and can radiate radio frequency energy and, if not installed and used in accordance with the instructions, may cause harmful interference to radio communications. However, there is no guarantee that interference will not occur in a particular installation. If this

equipment does cause harmful interference to radio or television reception, which can be determined by turning the equipment off and on, the user is encouraged to try to correct the interference by one or more of the following measures:

- Reorient or relocate the receiving antenna.
- Increase the separation between the equipment and receiver.
- Connect the equipment into an outlet on a circuit different from that to which the receiver is connected.
- Consult the dealer or an experienced radio/television technician for help.



**Nikon**

**COOLPIX P520**

#### **CAUTIONS**

##### **Modifications**

The FCC requires the user to be notified that any changes or modifications made to this device that are not expressly approved by Nikon Corporation may void the user's authority to operate the equipment.

##### **Interface Cables**

Use the interface cables sold or provided by Nikon for your equipment. Using other interface cables may exceed the limits of Class B Part 15 of the FCC rules.

## **Notice for Customers in the State of California**

### **WARNING**

Handling the cord on this product will expose you to lead, a chemical known to the State of California to cause birth defects or other reproductive harm.

#### ***Wash hands after handling.***

Nikon Inc.,  
1300 Walt Whitman Road,  
Melville, New York 11747-3064  
USA  
Tel: 631-547-4200

## **Notice for Customers in Canada**

### **CAUTION**

This Class B digital apparatus complies with Canadian ICES-003.

### **ATTENTION**

Cet appareil numérique de la classe B est conforme à la norme NMB-003 du Canada.

## **Notices for Customers in Europe**

### **CAUTIONS**

#### **RISK OF EXPLOSION IF BATTERY IS REPLACED BY AN INCORRECT TYPE.**

#### **DISPOSE OF USED BATTERIES ACCORDING TO THE INSTRUCTIONS.**

This symbol indicates that this product is to be collected separately.



The following apply only to users in European countries:

- This product is designated for separate collection at an appropriate collection point. Do not dispose of as household waste.
- For more information, contact the retailer or the local authorities in charge of waste management.

This symbol on the battery indicates that the battery is to be collected separately.



The following apply only to users in European countries:

- All batteries, whether marked with this symbol or not, are designated for separate collection at an appropriate collection point. Do not dispose of as household waste.
- For more information, contact the retailer or the local authorities in charge of waste management.

## <Important> Notes on GPS

### ● Location name data of this camera

Before using the GPS function, make sure to read “USER LICENSE AGREEMENT FOR LOCATION NAME DATA” (☞15) and agree to the terms.

- The location name information (Point of Interest: POI) stands as of April 2012. The location name information will not be updated.
- Use location name information only as a guide.
- The location name information (Point of Interest: POI) of the People's Republic of China (“China”) and the Republic of Korea is not provided for the COOLPIX P520.

### ● GPS Functions

- Use information measured by the camera as a guideline only. This information cannot be used for navigation of an airplane, car, and person or land survey applications.
- When **Record GPS data** in **GPS options** of the GPS options menu is set to **On**, GPS functions will continue to operate even after the camera is turned off (☞99). The electromagnetic waves emitted from this product may affect the measuring instruments of an airplane or medical equipment. When use of the product is prohibited or limited during airplane takeoffs and landings or inside a hospital, set **Record GPS data** to **Off** and then turn off the camera.
- An individual may be identified from still pictures or movies that have been recorded with location information. Observe caution when you transfer still pictures or movies recorded with location information, or GPS log files to a third party or upload them to a network such as the Internet where the public can view them. Be sure to read “Disposing of Data Storage Devices” (☞v).

### ● Using the camera overseas

Before taking the camera with GPS function overseas for travel, consult your travel agency or embassy of the country you are visiting to confirm whether there is any restriction on use.





























For example, you cannot record location information logs without permission from the government in China. Set the **Record GPS data** to **Off**.

- The GPS may not function properly in China and on the borders between China and neighboring countries (as of December 2012).





















































# Table of Contents

Introduction .....	ii
Read This First.....	ii
About This Manual.....	iii
Information and Precautions.....	iv
For Your Safety .....	vi
WARNINGS .....	vi
Notices .....	ix
<Important> Notes on GPS.....	xi
Parts of the Camera and Main Functions.....	1
The Camera Body.....	1
Principle Functions of the Controls.....	3
Attaching the Camera Strap and Lens Cap.....	6
Opening and Adjusting the Angle of the Monitor.....	7
Using the Viewfinder.....	8
Switching the Monitor Screen ( <b>DISP</b> Button).....	9
Basic Menu Operations.....	10
Monitor Screen .....	12
The Basics of Shooting and Playback.....	16
Preparation 1 Insert the Battery.....	16
Preparation 2 Charge the Battery.....	18
Preparation 3 Insert a Memory Card.....	20
Internal Memory and Memory Cards.....	21
Approved Memory Cards.....	21
Step 1 Turn the Camera On .....	22
Turning the Camera On and Off.....	23
Setting the Display Language, Date, and Time.....	24
Step 2 Select a Shooting Mode.....	26
Available Shooting Modes.....	27
Step 3 Frame a Picture.....	28
Using the Zoom.....	29
Step 4 Focus and Shoot .....	30
Step 5 Play Back Images .....	32
Step 6 Delete Unwanted Images.....	33

Shooting Features.....	35
<b>A</b> (Auto) Mode.....	35
Scene Mode (Shooting Suited to Scenes) .....	36
Viewing a Description (Help Information) of Each Scene .....	36
Characteristics of Each Scene .....	37
Using Skin Softening .....	46
Special Effects Mode (Applying Effects When Shooting).....	47
<b>P, S, A, M</b> Modes (Setting the Exposure for Shooting).....	49
<b>U</b> (User Setting Modes) .....	53
Saving Settings in <b>U</b> Mode .....	54
Features That Can Be Set Using the Multi Selector.....	55
Available Functions .....	55
Using the Flash (Flash Modes) .....	56
Using the Self-timer .....	59
Shooting Smiling Faces Automatically (Smile Timer).....	60
Using Focus Mode .....	62
Adjusting Brightness (Exposure Compensation).....	64
List of the Default Settings.....	65
Features That Can Be Set Using the <b>MENU</b> (Menu) Button (Shooting Mode) .....	67
Options Available in the Shooting Menu.....	68
Functions That Can Be Set Using the <b>Fn</b> (Function) Button.....	71
Changing the Image Quality and Image Size .....	72
Image Quality.....	72
Image Size .....	73
Features Not Available in Combination .....	75
The Control Range of the Shutter Speed ( <b>P, S, A, M</b> Modes) .....	78
Focusing on Subject.....	79
Using the Target Finding AF .....	79
Using Face Detection .....	80
Focus Lock.....	81
Autofocus .....	81
Playback Features.....	82
Playback Zoom.....	82
Viewing Several Images (Thumbnail Playback and Calendar Display).....	83
Features That Can Be Set Using the <b>MENU</b> (Menu) Button (Playback Mode) .....	84
Available Playback Menus.....	84
Using the Screen for Selecting Images.....	86
Connecting the Camera to a TV, Computer, or Printer .....	87
Using ViewNX 2.....	88
Installing ViewNX 2.....	88
Transferring Images to the Computer .....	90
Viewing Images .....	91

Recording and Playing Back Movies.....	92
Recording Movies .....	92
Features That Can Be Set Using the MENU (Menu) Button (Movie Menu).....	96
Available Movie Menus .....	96
Playing Back Movies.....	97
Using GPS .....	98
Starting GPS Data Recording.....	98
Features That Can Be Set Using the MENU (Menu) Button (GPS Options Menu).....	101
Options Available in the GPS Options Menu.....	101
General Camera Setup.....	103
The Setup Menu .....	103
Reference Section.....	
Taking Pictures With Manual Focus.....	
Using Easy Panorama (Shooting and Playing back) .....	
Taking Pictures with Easy Panorama.....	
Viewing Easy Panorama (Scroll).....	
Using Panorama Assist.....	
Playing Images in a Sequence.....	
Editing Still Images.....	
Editing Features .....	
 Quick Retouch: Enhancing Contrast and Saturation.....	
 D-Lighting: Enhancing Brightness and Contrast .....	
 Skin Softening: Softening Skin Tones .....	
 Filter Effects: Applying Digital Filter Effects .....	
 Small Picture: Reducing the Size of an Image.....	
 Crop: Creating a Cropped Copy .....	
Connecting the Camera to a TV (Viewing Images on a TV) .....	
Connecting the Camera to a Printer (Direct Print) .....	
Connecting the Camera to a Printer.....	
Printing Individual Images.....	
Printing Multiple Images.....	
Editing Movies.....	
Extracting Only the Desired Portions of the Movie.....	
Saving a Frame from a Movie as a Still Picture .....	



<b>Shooting Menu (P, S, A or M Mode)</b> .....	 26
Image Quality and Image Size.....	 26
Picture Control (COOLPIX Picture Control).....	 26
Custom Picture Control (COOLPIX Custom Picture Control).....	 30
White Balance (Adjusting Hue).....	 31
Metering.....	 33
Continuous Shooting.....	 34
ISO Sensitivity.....	 38
Exposure Bracketing.....	 39
AF Area Mode.....	 40
Autofocus Mode.....	 44
Flash Exp. Comp.....	 45
Noise Reduction Filter.....	 45
Active D-Lighting.....	 46
Save User Settings/Reset User Settings.....	 46
Zoom Memory.....	 47
Startup Zoom Position.....	 47
<b>Movie Menu</b> .....	 48
Movie Options.....	 48
Autofocus Mode.....	 51
<b>The Playback Menu</b> .....	 52
 Print Order (Creating a DPOF Print Order).....	 52
 Slide Show.....	 54
 Protect.....	 55
 Rotate Image.....	 55
 Voice Memo.....	 56
 Copy (Copy Between Internal Memory and Memory Card).....	 57
 Sequence Display Options.....	 58
 Choose Key Picture.....	 58
<b>GPS Options Menu</b> .....	 59
GPS Options.....	 59
Points of Interest (POI)	
(Recording and Displaying Location Name Information).....	 60
Create Log (Record the Log of Moving Information).....	 61
View Log.....	 63
Synchronize.....	 63
<b>The Setup Menu</b> .....	 64
Welcome Screen.....	 64
Time Zone and Date.....	 65
Monitor Settings.....	 67
Print Date (Imprinting Date and Time on Pictures).....	 68
Vibration Reduction.....	 69
Motion Detection.....	 70
AF Assist.....	 71
Digital Zoom.....	 71
Assign Side Zoom Control.....	 72

# Table of Contents

Sound Settings.....	73
Auto Off .....	73
Format Memory/Format Card.....	74
Language.....	74
TV Settings.....	75
Charge by Computer.....	76
Toggle Av/Tv Selection.....	78
Reset File Numbering.....	78
Blink Warning .....	79
Eye-Fi Upload .....	80
Reverse Indicators .....	80
Reset All .....	81
Firmware Version.....	84
<b>Error Messages .....</b>	<b>85</b>
<b>File and Folder Names .....</b>	<b>90</b>
<b>Optional Accessories .....</b>	<b>92</b>

---

---

## Technical Notes and Index ..... 1

---

---

<b>Caring for the Products .....</b>	<b>2</b>
The Camera .....	2
The Battery.....	3
Charging AC Adapter .....	4
The Memory Cards.....	5
<b>Caring for the Camera .....</b>	<b>6</b>
Cleaning .....	6
Storage.....	6
<b>Troubleshooting .....</b>	<b>7</b>
<b>USER LICENSE AGREEMENT FOR LOCATION NAME DATA.....</b>	<b>15</b>
<b>Specifications .....</b>	<b>19</b>
Supported Standards .....	22
<b>Index.....</b>	<b>24</b>

# Parts of the Camera and Main Functions

## The Camera Body

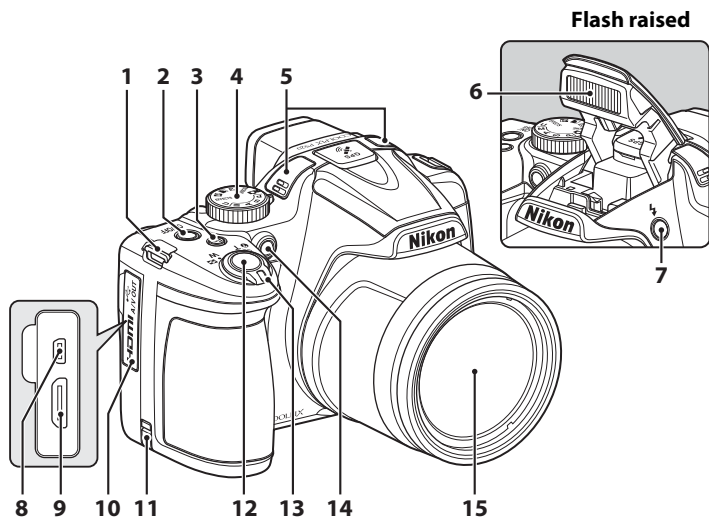

<b>1</b>	Eyelet for camera strap.....	6	<b>11</b>	Power connector cover (for an optional AC adapter) .....	92
<b>2</b>	Power switch/power-on lamp.....	23	<b>12</b>	Shutter-release button.....	3, 30
<b>3</b>	<b>F</b> n (function) button .....	4	<b>13</b>	Zoom control.....	29
<b>4</b>	Mode dial.....	26		<b>W</b> : Wide .....	29
<b>5</b>	Microphone (stereo).....	85, 92		<b>T</b> : Tele.....	29
<b>6</b>	Flash.....	56		: Thumbnail playback.....	83
<b>7</b>	(flash pop-up) button .....	56		: Playback zoom.....	82
<b>8</b>	USB/Audio video connector .....	18, 87		: Help .....	36
<b>9</b>	HDMI mini connector (Type C).....	87	<b>14</b>	Self-timer lamp.....	59
<b>10</b>	Connector cover .....	18, 87		AF-assist illuminator .....	104
			<b>15</b>	Lens	

# The Camera Body

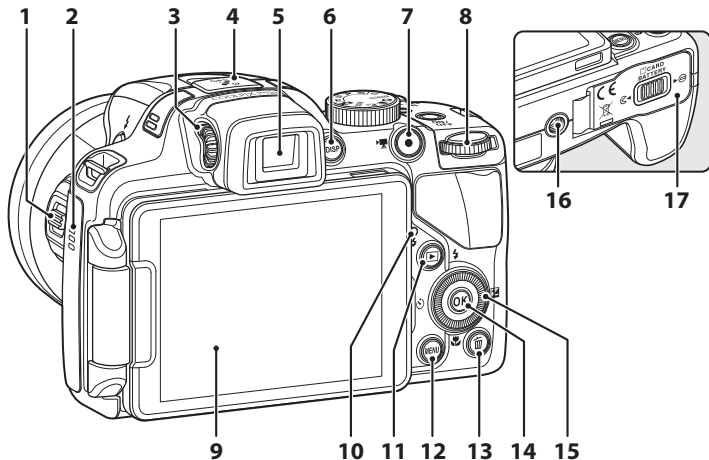

























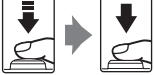

<b>1</b>	Side zoom control..... 104 <b>W</b> : Wide ..... 29 <b>T</b> : Tele..... 29	<b>10</b>	Charge lamp ..... 18,  77 Flash lamp ..... 56
<b>2</b>	Speaker ..... 85, 97, 104	<b>11</b>	(playback) button..... 32, 97
<b>3</b>	Diopter adjustment control..... 8	<b>12</b>	<b>MENU</b> (menu) button ..... 10
<b>4</b>	GPS antenna ..... 99	<b>13</b>	(delete) button..... 33, 97
<b>5</b>	Electronic viewfinder ..... 8	<b>14</b>	<b>OK</b> (apply selection) button ..... 3, 5
<b>6</b>	<b>DISP</b> (display) button ..... 9	<b>15</b>	Rotary multi selector (multi selector)* ..... 3, 5
<b>7</b>	(*  movie-record) button ..... 32, 92	<b>16</b>	Tripod socket
<b>8</b>	Command dial ..... 3, 5, 49	<b>17</b>	Battery-chamber/memory card slot cover..... 16, 20
<b>9</b>	Monitor ..... 12, 26		

\* The rotary multi selector is sometimes referred to as “multi selector” in this manual.



## Principle Functions of the Controls













### For Shooting

Control	Main Function	
 <p>Mode dial</p>	Change the shooting mode.	26
 <p>Zoom control</p>	Rotate toward <b>T</b> (Q) (telephoto zoom position) to zoom in, and rotate toward <b>W</b> (checkered flag) (wide-angle position) to zoom out.	29
 <p>Rotary multi selector</p>	<ul style="list-style-type: none"> <li>While the shooting screen is displayed: Display the setting screen for  (flash mode) by pressing up () , for  (self-timer/smiley timer) by pressing left () , for  (focus mode) by pressing down () and for  (exposure compensation) by pressing right () .</li> <li>When the shooting mode is <b>A</b> or <b>M</b>: Rotate the rotary multi selector to set the aperture value.</li> <li>While the setting screen is displayed: Select items using , , , or , or by rotating the rotary multi selector; apply the selection by pressing the  button.</li> </ul>	55 49, 51 10
 <p>Command dial</p>	<ul style="list-style-type: none"> <li>When the shooting mode is <b>P</b>: Set the flexible program.</li> <li>When the shooting mode is <b>S</b> or <b>M</b>: Set the shutter speed.</li> <li>While the setting screen is displayed: Select an item.</li> </ul>	49 51 10
 <p>MENU (menu) button</p>	Display and hide the menu.	10
 <p>Shutter-release button</p>	<p>When pressed halfway (i.e., if you stop pressing when you feel resistance slightly): Set focus and exposure.</p> <p>When pressed all the way (i.e., if you press the button all the way): Release the shutter.</p>	30

Control	Main Function	
 ● (▶ movie-record) button	Start and stop movie recording.	92
 Fn (function) button	When the shooting mode is <b>P, S, A, M</b> or <b>U</b> : Display or close the setting menus such as <b>Continuous</b> or <b>Vibration reduction</b> .	71
 Side zoom control	Use the function assigned with <b>Assign side zoom control</b> .	29, 104
 DISP (display) button	Switch the information displayed on the monitor screen.	9
 Playback button	Play back images.	32
 Delete button	Delete the last image that was saved.	33

## For Playback

Control	Main Function	
 Playback button	<ul style="list-style-type: none"> <li>When the camera is turned off, press and hold this button to turn the camera on in playback mode.</li> <li>Return to shooting mode.</li> </ul>	23 32
 Zoom control	<ul style="list-style-type: none"> <li>Enlarge the image when rotated toward <b>T</b> (Q); display image thumbnail or the calendar when rotated toward <b>W</b> (R).</li> <li>Adjust the volume for voice memo and movie playback.</li> </ul>	82, 83 85, 97

Control	Main Function	
 Rotary multi selector	<ul style="list-style-type: none"> <li>While the playback screen is displayed: Change the displayed image by pressing up (▲), left (◀), down (▼), right (▶), or by rotating the rotary multi selector.</li> <li>While the setting screen is displayed: Select an item by pressing ▲, ▼, ◀ or ▶, or by rotating the rotary multi selector.</li> <li>While the enlarged image is displayed: Move the display position.</li> </ul>	32  10  82
 Apply selection button	<ul style="list-style-type: none"> <li>Display individual images of a sequence in full-frame.</li> <li>Scroll an image recorded with Easy panorama.</li> <li>Play back movies.</li> <li>Switch from image thumbnail or zoomed image display to full-frame playback mode.</li> <li>While the setting screen is displayed, apply the selection.</li> </ul>	32,  8 43,  5 97 83  10
 Command dial	Switch the magnification of an enlarged image.	82
 <b>MENU</b> (menu) button	Display and hide the menu.	10
 Delete button	Delete images.	33
 <b>DISP</b> (display) button	Switch the information displayed on the monitor screen.	9
 Shutter-release button	Return to shooting mode.	-
  (movie-record) button		

## Attaching the Camera Strap and Lens Cap

Attach the Lens Cap LC-CP24 to the strap, and then attach the strap to the camera.

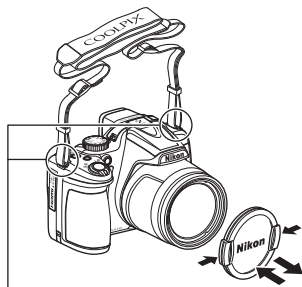
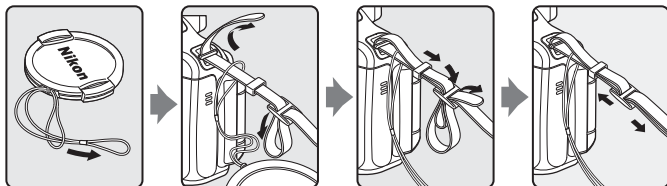

Attach the strap at two places.

### ✓ Lens Cap

- Remove the lens cap before you shoot a picture.
- At times when you are not shooting pictures such as when the power is off, or while you are carrying the camera, attach the lens cap to the camera to protect the lens.
- Do not attach other than the lens cap to the lens.



## Opening and Adjusting the Angle of the Monitor

The orientation and tilt of the monitor on the camera can be changed. This is useful when shooting with the camera in a high or a low position, or when taking self-portraits.

For normal shooting, fold the monitor screen against the camera face out (③).

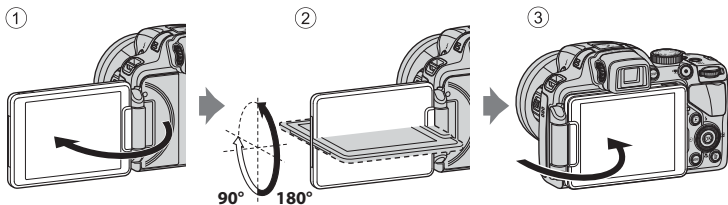

When you are not using or carrying the camera, fold the monitor with the screen facing the camera body to prevent scratches or contamination.



### ✔ Note on Monitor

When moving the monitor, do not apply excessive force and turn slowly within the monitor's adjustable range so that the connection will not be damaged.

### 📖 More Information

See "Using the Viewfinder" (📖8) for more information.

### Using the Viewfinder

Use the viewfinder to frame pictures when bright light makes it difficult to see the display on the monitor.

When the monitor is stored in the camera by facing inward, a picture that was displayed on the monitor is displayed on the viewfinder.

- You cannot turn on both viewfinder and monitor at the same time.
- While the viewfinder is used, the power-on lamp (green) lights.

When the image in the viewfinder is difficult to see, adjust by rotating the diopter adjustment control while looking through the viewfinder.

- Take care not to scratch your eye with your fingertips or nails.

Diopter adjustment control

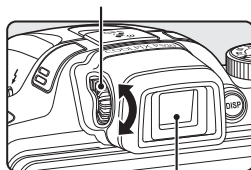

Viewfinder



## Switching the Monitor Screen (DISP Button)

To switch the information displayed on the monitor screen during shooting and playback, press the **DISP** (display) button.

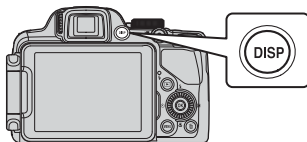

### For Shooting

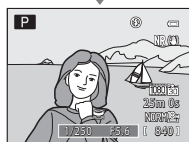

**Display information**  
Display the picture and the shooting information.

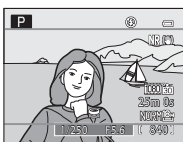

**Movie frame**  
Display the range of a movie in a frame.



**Information hidden**  
Display the picture only.

### For Playback

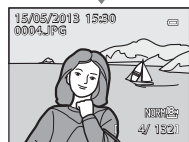

**Display photo information**  
Display the picture and photo information.

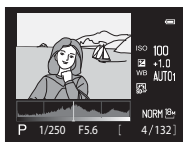

**Tone level information\* (excluding movies)**  
Display a histogram, tone level and shooting information.



**Information hidden**  
Display the picture only.

\* See 15 for more information on tone level information.

## Histogram and Framing Grid Displays for Shooting

The display options for the monitor screen can be changed in **Monitor settings** in the setup menu ( 103). A histogram and framing grid are available as the display options.

# Basic Menu Operations

Once the menu is displayed, various settings can be changed.

## 1 Press the MENU button.

- The menu that matches the status of the camera, such as shooting or playback mode, is displayed.

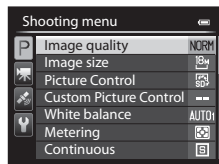
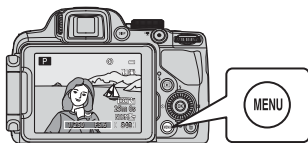

## 2 Use the multi selector to select a menu item.

- ▲ or ▼: Select an item above or below. An item can also be selected by rotating the multi selector.
- ◀ or ▶: Select an item on the left or right, or move between menu levels.
- OK: Apply a selection. Pressing ▶ also applies a selection.
- See "Switching Among Menu Tabs" (111) for more information.



Apply selection

## 3 After completing the settings, press the MENU button or shutter-release button.

- Press the shutter-release button to display the shooting screen.

### Note on the Command Dial Operation When Menus are Displayed

Rotating the command dial when menus are displayed allows you to change the setting values of a selected item. There are some setting values that cannot be changed using the command dial.

## Switching Among Menu Tabs

To display a different menu, such as the setup menu (📖103), use the multi-selector to switch to another tab.

### Tabs

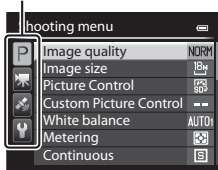

Press ◀ to move to the tab.



Press ▲ or ▼ to select the tab, and press the OK button or ▶ to apply the selection.

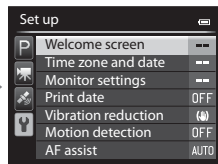

## Tab Types

For Shooting	For Playback
<p><b>P</b> tab: Displays the settings available for the current shooting mode (📖27). Depending on the current shooting mode, the tab icon that is displayed will be different.</p> <p><b>📷</b> tab: Displays movie recording settings.</p> <p><b>📍</b> tab: Displays the GPS options menu (📖101) settings.</p> <p><b>🔧</b> tab: Displays the setup menu (📖103), where you can change general settings.</p>	<p><b>▶</b> tab: Displays the settings available for the playback mode.</p>

# Monitor Screen

The information that is displayed on the monitor during shooting and playback changes depending on the camera's settings and state of use. Press the **DISP** (display) button to hide or show the information on the monitor ( 9).

## For Shooting

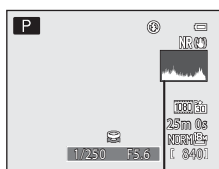
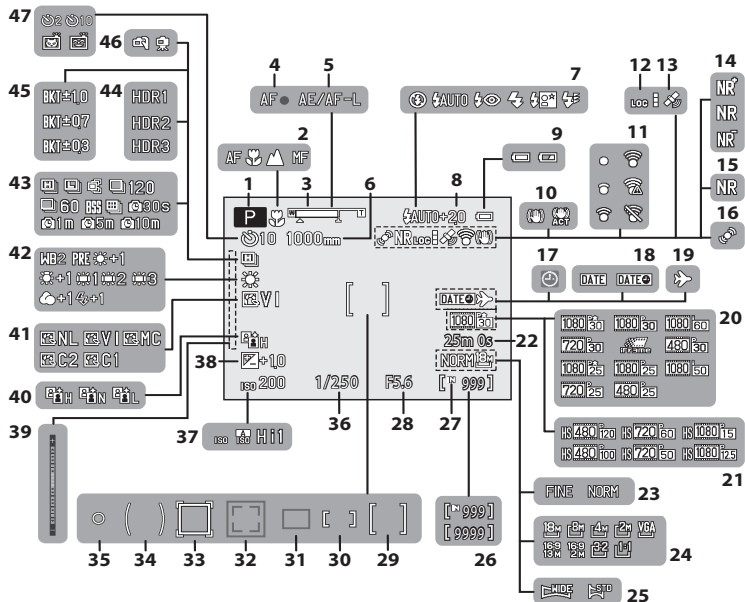



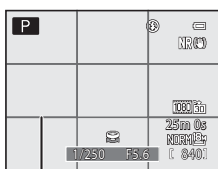

48

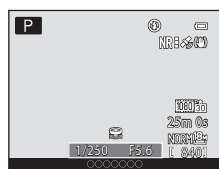

49



50

<b>1</b>	Shooting mode.....	26, 27
<b>2</b>	Focus mode.....	63
<b>3</b>	Zoom indicator .....	29, 63
<b>4</b>	Focus indicator.....	31
<b>5</b>	AE/AF-L indicator.....	45, 
<b>6</b>	Zoom memory .....	69
<b>7</b>	Flash mode .....	57
<b>8</b>	Flash exp. comp.....	69
<b>9</b>	Battery level indicator .....	22
<b>10</b>	Vibration reduction icon .....	104
<b>11</b>	Eye-Fi communication indicator .....	106, 
<b>12</b>	Log display .....	102
<b>13</b>	GPS reception .....	100
<b>14</b>	Noise reduction filter.....	69
<b>15</b>	Noise reduction burst .....	38
<b>16</b>	Motion detection icon .....	104
<b>17</b>	"Date not set" indicator.....	25, 103
<b>18</b>	Print date.....	103
<b>19</b>	Travel destination indicator .....	103
<b>20</b>	Movie options (normal speed movies) .....	96
<b>21</b>	Movie options (HS movies).....	96
<b>22</b>	Movie length .....	92, 
<b>23</b>	Image quality .....	72
<b>24</b>	Image size.....	73
<b>25</b>	Easy panorama .....	43
<b>26</b>	Number of exposures remaining (still pictures).....	22, 74
<b>27</b>	Internal memory indicator.....	22, 92
<b>28</b>	Aperture value .....	49
<b>29</b>	Focus area (for center) .....	69, 81
<b>30</b>	Focus area (for manual).....	41, 42, 69
<b>31</b>	Focus area (for auto, target finding AF).....	31, 69, 79
<b>32</b>	Focus area (for face detection, pet detection) .....	44, 60, 69, 80
<b>33</b>	Focus area (for subject tracking).....	69
<b>34</b>	Center-weighted area .....	68
<b>35</b>	Spot metering area .....	68
<b>36</b>	Shutter speed.....	49
<b>37</b>	ISO sensitivity .....	69
<b>38</b>	Exposure compensation value.....	64
<b>39</b>	Exposure indicator .....	51
<b>40</b>	Active D-Lighting.....	69
<b>41</b>	COOLPIX Picture Control.....	68
<b>42</b>	White balance .....	68
<b>43</b>	Continuous shooting mode.....	44, 68
<b>44</b>	Backlighting (HDR) .....	38
<b>45</b>	Exposure bracketing .....	69
<b>46</b>	Hand-held/Tripod.....	37, 40
<b>47</b>	Self-timer .....	59
<b>47</b>	Smile timer .....	60
<b>47</b>	Pet portrait auto release .....	44
<b>48</b>	View/hide histograms .....	103, 
<b>49</b>	View/hide framing grid .....	103, 
<b>50</b>	Location name information (POI information).....	101

## For Playback

Full-frame display (📖32)

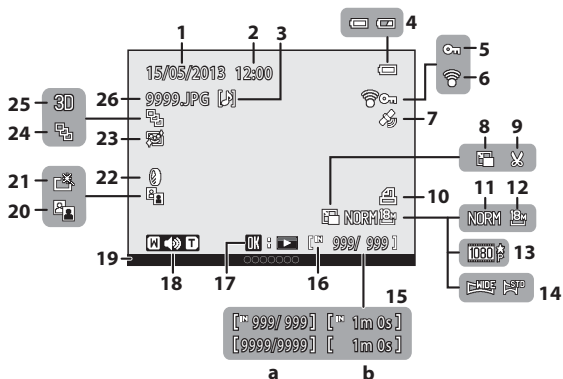

<b>1</b>	Date of recording.....	24	<b>16</b>	Internal memory indicator .....	32
<b>2</b>	Time of recording .....	24	<b>17</b>	Easy panorama playback guide ...	👓5
<b>3</b>	Voice memo indicator.....	85	<b>17</b>	Sequence playback guide .....	👓8
<b>4</b>	Battery level indicator .....	22		Movie playback guide .....	97
<b>5</b>	Protect icon.....	84	<b>18</b>	Volume indicator .....	85, 97
<b>6</b>	Eye-Fi communication indicator .....	106, 👓80	<b>19</b>	Location name information (POI information).....	101
<b>7</b>	Recorded GPS information indicator .....	100	<b>20</b>	D-Lighting icon .....	84
<b>8</b>	Small picture .....	84, 👓15	<b>21</b>	Quick retouch icon .....	84
<b>9</b>	Crop.....	82, 👓16	<b>22</b>	Filter effects icon.....	84
<b>10</b>	Print order icon .....	84	<b>23</b>	Skin softening icon.....	84
<b>11</b>	Image quality.....	72	<b>24</b>	Sequence display (when <b>Individual pictures</b> is set) .....	👓8
<b>12</b>	Image size.....	73	<b>25</b>	3D image indicator .....	45
<b>13</b>	Movie options.....	92, 96	<b>26</b>	File number and type .....	👓90
<b>14</b>	Easy panorama indicator.....	43			
<b>15</b>	(a) Current image number/ total number of images.....	32			
	(b) Movie length .....	97			

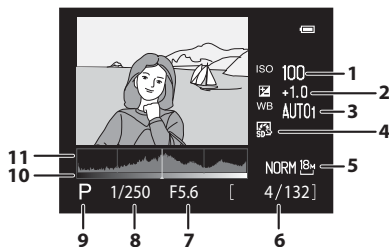

Tone level information display<sup>1</sup> (📖9)

<b>1</b>	ISO sensitivity.....	69	<b>7</b>	Aperture value .....	31
<b>2</b>	Exposure compensation value .....	64	<b>8</b>	Shutter speed .....	31
<b>3</b>	White balance .....	68	<b>9</b>	Shooting mode <sup>2</sup> .....	27
<b>4</b>	COOLPIX Picture Control.....	68	<b>10</b>	Tone level <sup>3</sup>	
<b>5</b>	Image quality/Image size .....	72	<b>11</b>	Histogram <sup>4</sup>	
<b>6</b>	Current image number/ total number of images .....	32			

<sup>1</sup> You can check for loss of contrast detail in highlights and shadows from the histogram that is displayed, or the flashing display for each tone level. These provide guidelines when adjusting the picture brightness with functions such as exposure compensation.

<sup>2</sup> **P** is displayed when the shooting mode **SCENE**, **SCENE**, **EFFECTS** or **P** is selected.

<sup>3</sup> The tone level indicates the brightness level. The tone level indicates the brightness level. When the tone level to check is selected by rotating the multi selector or pressing ◀ or ▶, the area of the picture that corresponds to the selected tone level flashes. Press the multi selector ▲ or ▼ to view the previous or next image.

<sup>4</sup> A histogram is a graph showing the distribution of tones in the image. The horizontal axis corresponds to pixel brightness, with dark tones to the left and bright tones to the right. The vertical axis shows the number of pixels.

# The Basics of Shooting and Playback

## Preparation 1 Insert the Battery

- 1 Open the battery-chamber/memory card slot cover.

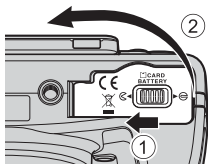

- 2 Insert the included battery (Rechargeable Li-ion Battery EN-EL5).

- Use the battery to push the orange battery latch down in the direction indicated by the arrow (1), and fully insert the battery (2).
- When the battery is inserted correctly, the battery latch will lock the battery in place.

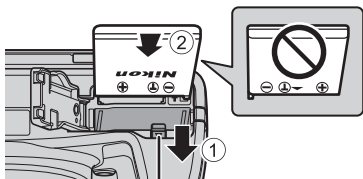

Battery latch

### Inserting the Battery Correctly

**Inserting the battery upside down or backwards could damage the camera.** Be sure to check that the battery is in the correct orientation.

- 3 Close the battery-chamber/memory card slot cover.

- Charge the battery before the first use or when the battery is running low (18).

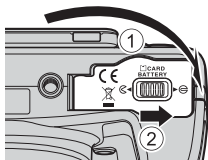

## Removing the Battery

Turn the camera off (📖23) and be sure that the power-on lamp and the monitor have turned off before opening the battery-chamber/memory card slot cover. To eject the battery, open the battery-chamber/memory card slot cover and push the orange battery latch in the direction shown (①). Then, remove the battery straight (②).

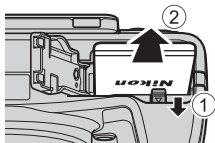

### ✔ High Temperature Caution

The camera, battery, and memory card may be hot immediately after using the camera. Observe caution when removing the battery or memory card.

### ✔ Notes on Battery

- Be sure to read and follow the warnings of "For Your Safety" (📖vi) thoroughly before using the battery.
- Be sure to read and follow the warnings for "The Battery" (🔋3) before using the battery.

## Preparation 2 Charge the Battery

### 1 Prepare the included Charging AC Adapter EH-69P.

If a plug adapter\* is included with your camera, attach the plug adapter to the plug on the Charging AC Adapter. Push the plug adapter firmly until it is securely held in place. Once the two are connected, attempting to forcibly remove the plug adapter could damage the product.

\* The shape of the plug adapter varies according to the country or region in which the camera was purchased. The Charging AC Adapter comes with the plug adapter attached in Argentina and Korea.

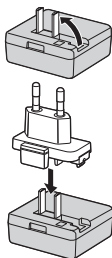

### 2 Make sure the battery is inserted in the camera, and then connect the camera to the Charging AC Adapter in order of ① to ③.

- Keep the camera turned off.
- When connecting the cable, be sure that the plug is properly oriented. Do not use force when connecting the cable to the camera. When disconnecting the cable, do not pull the plug at an angle.

Charge lamp

Electrical outlet

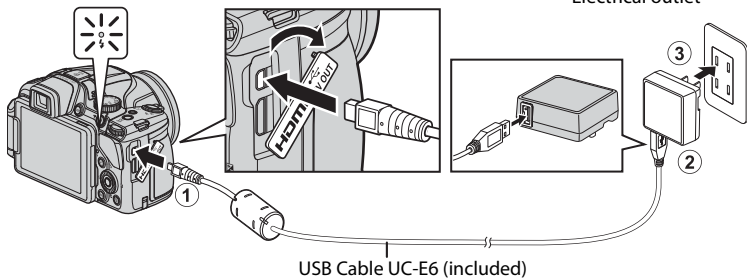

- When charging starts, the charge lamp flashes slowly in green.
- About 4 hours and 30 minutes are required to charge a fully exhausted battery.
- When the battery has been completely charged, the charge lamp turns off.
- See “Understanding the Charge Lamp” (📖19) for more information.

### 3 Disconnect the Charging AC Adapter from the electrical outlet and then disconnect the USB cable.

## Understanding the Charge Lamp

Status	Description
Flashes slowly (green)	The battery is charging.
Off	The battery is not charging. When charging is complete, the charge lamp flashing slowly in green stops and is turned off.
Flashes quickly (green)	<ul style="list-style-type: none"> <li>The ambient temperature is not suited to charging. Charge the battery indoors with an ambient temperature of 5°C to 35°C (41°F to 95°F).</li> <li>The USB cable or Charging AC Adapter is not properly connected, or there is a problem with the battery. Disconnect the USB cable or unplug the Charging AC Adapter and correctly connect it again, or change the battery.</li> </ul>

### Notes on Charging AC Adapter

- Be sure to read and follow the warnings of “For Your Safety” (📖vi) thoroughly before using the Charging AC Adapter.
- Be sure to read thoroughly and follow the warnings for “Charging AC Adapter” (🔌4) before use.

### Charging Using Computer or Battery Charger

- You can also charge the Rechargeable Li-ion Battery EN-EL5 by connecting the camera to a computer (📖87, 105).
- The EN-EL5 can be charged without using the camera by using the Battery Charger MH-61 (available separately; 📖92).

### Operating the Camera During Charging

The camera does not turn on while the Charging AC Adapter is connected to it even when you press the power switch. Press and hold the  (playback) button to turn on the camera in playback mode and play back images. Shooting is not possible.

### AC Power Source

- You can take pictures and play back images while using the AC Adapter EH-62A (available separately; 📖92) to power the camera from an electrical outlet.
- Do not, under any circumstances, use another make or model of AC adapter other than the EH-62A. Failure to observe this precaution could result in overheating or damage to the camera.

## Preparation 3 Insert a Memory Card

- 1 Confirm that the power-on lamp and the monitor are turned off and open the battery-chamber/memory card slot cover.
  - Be sure to turn off the camera before opening the cover.

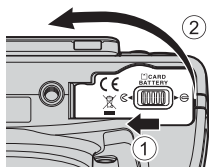

- 2 Insert the memory card.
  - Slide the memory card until it clicks into place.

### ✓ Inserting the Memory Card Correctly

Inserting the memory card upside down or backwards could damage the camera or the memory card. Be sure to confirm that the memory card is in the correct orientation.

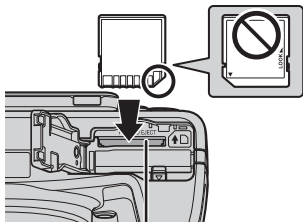

Memory card slot

- 3 Close the battery-chamber/memory card slot cover.
  - Be sure to turn off the camera before opening the cover.

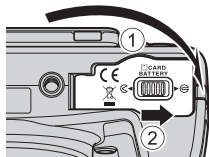

### ✓ Formatting a Memory Card

- The first time you insert a memory card that has been used in another device into this camera, be sure to format it with this camera.
- **All data stored on a memory card is permanently deleted when the card is formatted.** Be sure to make copies of any data you wish to keep before formatting the memory card.
- To format a memory card, insert the memory card into the camera, press the **MENU** button and select **Format card** from the setup menu (📖103).

### ✓ Note on Memory Cards

Refer to the documentation included with the memory card, as well as “The Memory Cards” (🔍5) in “Caring for the Products.”

## Removing Memory Cards

Before opening the battery-chamber/memory card slot cover, turn the camera off and confirm that the power-on lamp and the monitor are off.

Press the memory card in lightly with your finger (①) to partially eject it, and then pull it out straight (②).

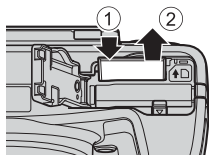

### High Temperature Caution

The camera, battery, and memory card may be hot immediately after using the camera. Observe caution when removing the battery or memory card.

## Internal Memory and Memory Cards

Camera data, including images and movies, can be saved in either the camera's internal memory (approximately 15 MB) or on a memory card. To use the camera's internal memory for shooting or playback, first remove the memory card.

## Approved Memory Cards

The following Secure Digital (SD) memory cards have been tested and approved for use in this camera.

- When recording a movie onto a memory card, a memory card with an SD speed class of Class 6 or higher is recommended. If the transfer speed of the card is slow, the movie recording may end unexpectedly.

	SD memory cards	SDHC memory cards <sup>2</sup>	SDXC memory cards <sup>3</sup>
SanDisk	2 GB <sup>1</sup>	4 GB, 8 GB, 16 GB, 32 GB	64 GB, 128 GB
TOSHIBA	2 GB <sup>1</sup>	4 GB, 8 GB, 16 GB, 32 GB	64 GB
Panasonic	2 GB <sup>1</sup>	4 GB, 8 GB, 16 GB, 32 GB	64 GB
Lexar	-	4 GB, 8 GB, 16 GB, 32 GB	64 GB, 128 GB

- Before using a card reader or similar device, check that the device supports 2 GB cards.
- SDHC-compliant. Before using a card reader or similar device, check that the device supports SDHC.
- SDXC-compliant. Before using a card reader or similar device, check that the device supports SDXC.



- Contact the manufacturer for details on the above cards.

## Step 1 Turn the Camera On

- 1 Open the monitor and remove the lens cap.
  - See “Opening and Adjusting the Angle of the Monitor” (📖7) for more information.

- 2 Press the power switch to turn on the camera.

- **If you are turning the camera on for the first time, see “Setting the Display Language, Date, and Time”** (📖24).
- The lens extends, and the monitor is turned on.

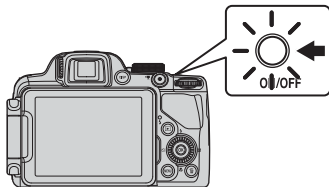

- 3 Check the battery level and number of exposures remaining.

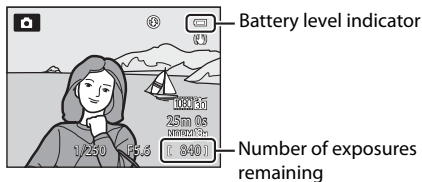

### Battery Level

Display	Description
	Battery level high.
	Battery level low. Prepare to charge or replace the battery.
 Battery exhausted.	Cannot take pictures. Charge or replace the battery.



### Number of Exposures Remaining

The number of exposures remaining is displayed.

- When a memory card is not inserted, is displayed and pictures are recorded to the internal memory (approx. 15 MB).
- The number of pictures that can be stored depends on the remaining capacity of the internal memory or memory card, the image quality, and the image size (📖72).
- The number of exposures remaining shown in the illustration differs from the actual value.





## Turning the Camera On and Off

- When the camera is turned on, the power-on lamp (green) lights and the monitor is turned on (the power-on lamp turns off when the monitor is turned on).
- If the power switch is pressed while the monitor is closed with the screen facing inward, the power-on lamp (green) and viewfinder will light.
- To turn off the camera, press the power switch. Both the monitor and the power-on lamp are turned off.
- To turn on the camera in playback mode, press and hold the  (playback) button. At this time, the lens does not extend.
- When **Record GPS data** in **GPS options** of the GPS options menu is set to **On**, GPS functions will continue to operate even after the camera is turned off (99).

### Power Saving Function (Auto Off)

If no operations are performed for a while, the monitor will turn off, the camera will enter standby mode, and the power-on lamp will flash. If no operations are performed for another 3 minutes, the camera will turn off automatically.

- To turn on the monitor again in standby mode, perform either one of the following operations.
  - Press the power switch, shutter-release button,  button, or  movie-record) button.
  - Rotate the mode dial.
- The time that elapses before the camera enters standby mode can be changed using the **Auto off** setting in the setup menu (103).
- By default, the camera enters standby mode in about 1 minute when you are using shooting mode or playback mode.
- If you are using the AC Adapter EH-62A (available separately), the camera enters standby mode after 30 minutes. This setting cannot be changed.

### Note on Battery Drain

Battery power drains faster than usual while the camera is recording log data (102) or using a Wi-Fi connection.

### Monitor Display

Press the **DISP** button to switch between showing and hiding the photo information or shooting information that is displayed on the monitor screen (9).

## Setting the Display Language, Date, and Time

Dialogs for language selection and camera clock setting are displayed the first time the camera is turned on.

- 1 Press the multi selector ▲ or ▼ to choose the desired language and press the **OK** button.

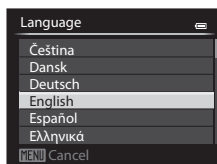

- 2 Press ▲ or ▼ to choose **Yes** and press the **OK** button.

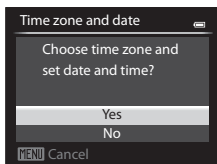

- 3 Press ◀ or ▶ to select your home time zone, and press the **OK** button.

- In regions where daylight saving time applies, press ▲ to enable the daylight saving time function. ☀ will be displayed. To disable the daylight saving time function, press ▼.

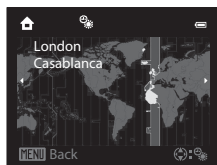

- 4 Press ▲ or ▼ to choose the date display order and press the **OK** button or ▶.

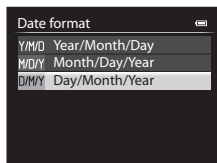

## 5 Press ▲, ▼, ◀ or ▶ to set date and time, and press the **OK** button.

- Choose an item: Press ▶ or ◀ (selected in the following order: **D** (day) → **M** (month) → **Y** (year) → **hour** → **minute**).
- Set the contents: Press ▲ or ▼. Date and time can also be set by rotating the multi selector or command dial.
- Confirm the settings: Select the **minute** field and press the **OK** button or ▶.

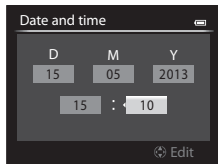

## 6 Press ▲ or ▼ to choose **Yes** and press the **OK** button.

- After finishing the setting, the lens extends and the shooting screen is displayed.

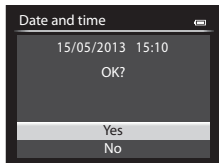

### The Clock Battery

- The camera's clock is powered by an internal backup battery. The backup battery charges after about 10 hours of charging when the main battery is inserted into the camera or when the camera is connected to an optional AC adapter. The backup battery operates the clock for several days.
- If the camera's backup battery becomes exhausted, the date and time setting screen is displayed when the camera is turned on. Set the date and time again. See step 2 of "Setting the Display Language, Date, and Time" (124) for more information.

### Changing the Language Setting and the Date and Time Setting



- You can change these settings using the **Language** and **Time zone and date** settings in **Y** setup menu (103).
- In the **Time zone** setting of **Time zone and date** in **Y** setup menu, when the daylight saving time function is enabled, the camera's clock is set forward by one hour, and when disabled, set back by one hour.
- If you exit without setting the date and time,  flashes when the shooting screen is displayed. Use the **Time zone and date** setting in the setup menu to set the date and time.

### Imprinting the Shooting Date in Printed Images



- Set the date and time before shooting.
- You can imprint the shooting date in images as they are captured by setting **Print date** in the setup menu.
- If you want the shooting date to be printed without using the **Print date** setting, print using the ViewNX 2 software (88).

## Step 2 Select a Shooting Mode

Rotate the mode dial to select the shooting mode.

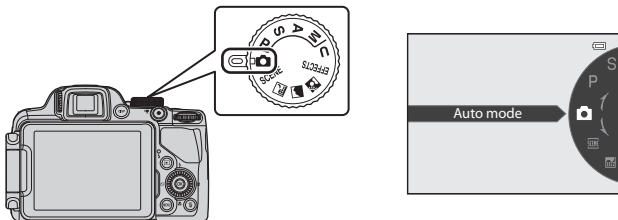
- The following describes how to take pictures in  (auto) mode as an example. Rotate the mode dial to .



- The camera switches to  (auto) mode and the shooting mode icon changes to .

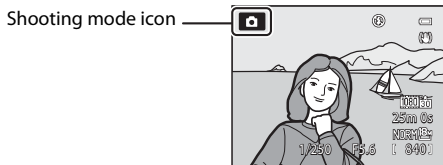

- See “Monitor Screen” (📖12) for more information.

### Note on the Flash

In situations where a flash is needed, such as in dark locations or when the subject is backlit, be sure to raise the flash (📖56).

## Available Shooting Modes

### P, S, A, M mode (📖49)

Choose these modes for greater control over shutter speed and aperture value. Settings in the shooting menu (📖67) are available to suit the shooting conditions and the type of shot you want to capture.

### U User settings mode (📖53)

Setting combinations that are frequently used for shooting can be saved. The saved settings can be immediately retrieved for shooting simply by rotating the mode dial to **U**.

### 📷 (auto) mode (📖35)

Shoot easily with basic camera operations without going into detailed settings.

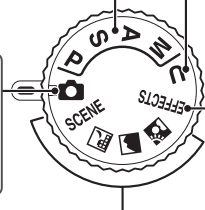

### EFFECTS Special effects mode (📖47)

Effects can be applied to pictures during shooting.

### Scene mode (📖36)

When one of the scene modes is selected, pictures are captured using settings that are optimized for the selected scene.

**SCENE** (Scene): Choose the desired scene using the scene menu, and the camera's settings are automatically optimized for the selected scene.

In scene auto selector mode, the camera automatically selects the optimum scene mode for simpler shooting.

- To select a scene, first rotate the mode dial to **SCENE** and press the **MENU** button. Select the desired scene by pressing the multi selector ▲ or ▼, and then press the **OK** button.

🌃 (Night landscape): Captures the atmosphere of night landscapes.

🏞️ (Landscape): Use this mode for vivid landscapes and cityscapes.

🌃 (Backlighting): The flash fires when there is backlight to prevent the subject from being hidden in shadow, or use the HDR function to shoot when there are very bright areas and very dark areas in the same frame.

## 🔧 Changing the Settings When Shooting

- Features That Can Be Set Using the Multi Selector → 📖55
- Features That Can Be Set Using the **MENU** (Menu) Button
  - Shooting menu → 📖67, 📖96
  - Setup menu → 📖103
- Functions That Can Be Set Using the Fn (Function) Button → 📖71

## Step 3 Frame a Picture

### 1 Ready the camera.

- Keep your fingers, hair, strap and other objects away from the lens, flash, AF-assist illuminator and microphone.

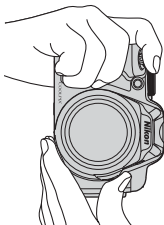
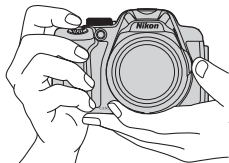

### 2 Frame the picture.

- Point the camera at the subject.

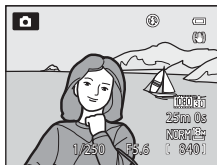

#### **Viewfinder**

Use the viewfinder to frame pictures (📖8) when bright light makes it difficult to see the display on the monitor.

#### **Using a Tripod**

- In the following situations, use of a tripod is recommended to avoid the effects of camera shake:
  - When shooting in a dark location with the flash lowered, or in a mode in which flash is disabled
  - When shooting in the telephoto zoom position
- To take a picture with the camera attached to a tripod, set **Vibration reduction** in the setup menu (📖103) to **Off**.

## Using the Zoom

Rotate the zoom control to activate the optical zoom.

- To zoom in so that the subject fills a larger area of the frame, rotate toward **T** (telephoto zoom position).
- To zoom out so that the area visible increases in the frame, rotate toward **W** (wide-angle position).
- Rotating the zoom control all the way in either direction adjusts the zoom quickly, while rotating the control partially adjusts the zoom slowly (except during movie recording).
- The zoom can also be operated by rotating the side zoom control (📖2) toward **T** or **W**.

The function of the side zoom control can be set in the **Assign side zoom control** in the setup menu (📖103).

- Amount of zoom is displayed at the top of the monitor screen when the zoom control is rotated.
- Rotating the zoom control toward **T** at the maximum optical zoom ratio triggers the digital zoom and the digital zoom can magnify up to about 2x beyond the maximum magnification of the optical zoom.

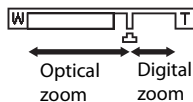
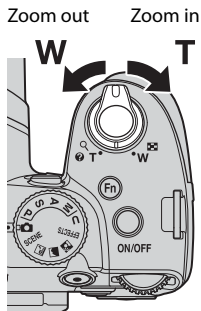

### Digital Zoom and Interpolation

- When the digital zoom is used, the image quality starts to deteriorate if the zoom position is increased beyond the 📏 position on the zoom bar. The 📏 position moves to the right as the image size (📖73) becomes smaller.
- Using **Digital zoom** in the setup menu (📖103), it is possible to set the digital zoom so that it does not operate.

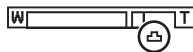

### More Information

- See "Zoom memory" (📖69) for more information.
- See "Startup zoom position" (📖69) for more information.

## Step 4 Focus and Shoot

### 1 Press the shutter-release button halfway to adjust the focus.

- “Pressing halfway” is the action of pressing the shutter-release button slightly until you feel resistance and then holding in that position.
- When the subject is in focus, the focus area or focus indicator (📖12) lights in green. If the focus area or focus indicator flashes in red, the subject is out of focus. Press the shutter-release button halfway again.
- See “Focus and Exposure” (📖31) for more information.

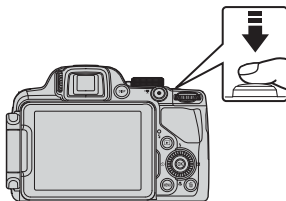

Focus area

### 2 Press the shutter-release button all the way to take a picture.

- “Pressing all the way” is the action of pressing the shutter-release button the rest of the way down.



### ✔ Note on Recording Images and Saving Movies

The indicator showing the number of exposures remaining or the indicator showing the maximum movie length flashes while images are being recorded or while a movie is being saved. **Do not open the battery-chamber/memory card slot cover or remove the battery or memory card while an indicator is flashing.** Doing this could result in loss of data, or in damage to the camera or the memory card.

### 📎 AF-assist Illuminator

In dark places, the AF-assist illuminator (📖1, 104) may light when the shutter-release button is pressed halfway.

### 📎 To Make Sure You Do Not Miss a Shot

If you are concerned that you might miss a shot, press the shutter-release button all the way without first pressing it halfway.



## Focus and Exposure

When the shutter-release button is pressed halfway, the camera sets the focus and exposure (combination of shutter speed and aperture value). The focus and exposure remain locked while the shutter-release button is pressed halfway.

- When the digital zoom is in effect, the camera focuses on the subject at the center of the frame, and the focus area is not displayed. When the subject is in focus, the focus indicator lights in green.
- The camera may not be able to focus on certain subjects. See “Autofocus” (📖81) for more information.
- In auto mode, the camera automatically selects the areas containing the subject closest to the camera out of 9 focus areas. When the subject is in focus, the focus areas that are in focus (up to 9 areas) light in green.

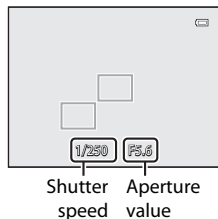

- When **P**, **S**, **A**, **M** or **U** mode is selected, the areas to be used for focusing can be set using **AF area mode** (📖69) in the shooting menu.
- The areas to be used for focusing in scene mode vary depending on the selected scene (📖36).
- In **EFFECTS** (special effects) mode, the camera focuses at the center of the frame.

### ✔ The Subject Is Too Close to the Camera

If the camera does not focus, try shooting with 🌸 (macro close-up) (📖63) in the focus mode, or **Close-up** (📖41) scene mode.

### 📖 More Information

See “Focusing on Subject” (📖79) for more information.



## Step 5 Play Back Images

### 1 Press the (playback) button.

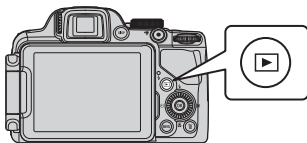
- When you switch to playback mode, the last image saved will be displayed in full-frame playback mode.





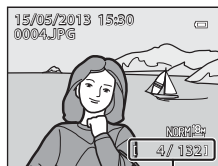

### 2 Use the multi selector to view previous or next images.

- To view previous images: ▲ or ◀
- To view next images: ▼ or ▶
- Images can also be selected by rotating the multi selector.
- To play back images that are saved in the internal memory, remove the memory card.  is displayed around “Current image number/total number of images” on the playback screen.
- To return to shooting mode, press the  button again, or press the shutter-release button, or ● (▶ ) movie-record) button.



Current image number/  
Total number of images



### Viewing Pictures

- Press the **DISP** button to switch between showing and hiding the photo information or shooting information that is displayed on the monitor screen (9).
- Pictures taken using face detection (80) or pet detection (44) will be rotated automatically when displayed in full-frame playback mode according to the orientation of the face.
- The orientation of an image can be changed using **Rotate image** in the playback menu (84).
- Press the **OK** button to display a sequence of images shot continuously as individual images. Press ▲ on the multi selector to return to the original display (see 8 for more information on the sequence display).
- Images may be displayed at low resolution immediately after switching to the previous or next image.

## Step 6 Delete Unwanted Images

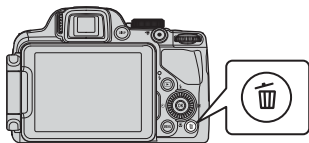

- 1 Press the  button to delete the image currently displayed on the monitor.



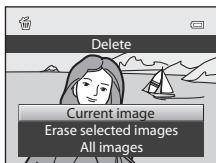

- 2 Press the multi selector  or  to select the desired deletion method and press the  button.

- **Current image:** Only the current image is deleted. If the key picture of a sequence is selected, all images in the sequence are deleted.
- **Erase selected images:** Multiple images can be selected and deleted. See “Operating the Erase Selected Images Screen” (📖34) for more information.
- **All images:** All images are deleted.
- To exit without deleting, press the **MENU** button.



- 3 Press  or  to select **Yes** and press the  button.

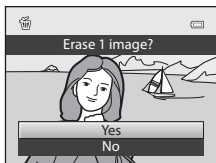

- Deleted images cannot be recovered.
- To cancel, press  or  to select **No** and press the  button.



### Notes on Deletion

- Deleted images cannot be recovered. Transfer important images to a computer before deleting them.
- Protected images (📖84) cannot be deleted.
- When images are taken with continuous shooting, each series of images is treated as a group (pictures in a sequence) and only the first picture in a group (key picture) is displayed in the default setting.

When you press the  button during key picture playback, all images in the key picture's sequence can be deleted.

To delete each picture in a sequence, before pressing the  button, press the  button to display each image in the sequence individually.

### Deleting the Last Image Captured While in Shooting Mode

When using shooting mode, press the  button to delete the last image that was saved.

## Operating the Erase Selected Images Screen

**1** Press the multi selector ◀ or ▶ to select an image to be deleted, and then press ▲ to display ✓.

- To cancel the selection, press ▼ to remove ✓.
- Rotate the zoom control (📖29) toward **T** (🔍) to switch back to full-frame playback or **W** (📐) to display thumbnails.

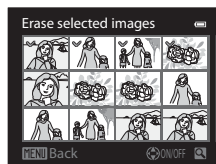

**2** Add ✓ to all images that you want to delete and then press the **OK** button to apply the selection.

- A confirmation dialog is displayed. Follow the instructions displayed on the monitor.

# Shooting Features

## (Auto) Mode

Shoot easily with basic camera operations without going into detailed settings.

The camera selects the focus area for autofocus in accordance with the composition or subject.

- The camera automatically selects the areas containing the subject closest to the camera out of 9 focus areas.  
When the subject is in focus, the focus areas that are in focus (up to 9 areas) light in green.
- See “Focus and Exposure” (📖31) for more information.

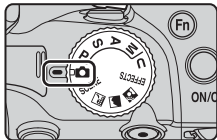

## Changing (Auto) Mode Settings

- Features That Can Be Set Using the Multi Selector → 📖55
- Features That Can Be Set Using the **MENU** (Menu) Button
  - Changing the Image Quality and Image Size → 📖72
  - Setup menu → 📖103

## Scene Mode (Shooting Suited to Scenes)

When one of the following scenes is selected using the mode dial or the scene menu, images are captured using settings that are optimized for the selected scene.

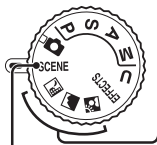

Night landscape (📖37), Landscape (📖38),  
 Backlighting (📖38)

Rotate the mode dial to , , or and take pictures.

### SCENE (Scene)

Press the **MENU** button to display the scene menu and choose one of the following shooting scenes.

Scene auto selector (default setting) (📖39)	Close-up (📖41)
Portrait (📖39)	Food (📖42)
Sports (📖40)	Museum (📖42)
Night portrait (📖40)	Fireworks show (📖42)
Party/indoor (📖40)	Black and white copy (📖42)
Beach (📖40)	Panorama (📖43)
Snow (📖40)	Pet portrait (📖44)
Sunset (📖41)	3D photography (📖45)
Dusk/dawn (📖41)	

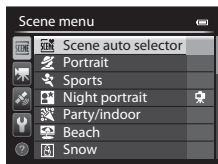
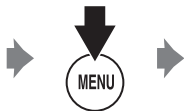
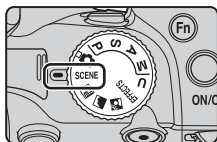

## Viewing a Description (Help Information) of Each Scene

Select the desired scene from the scene menu and rotate the zoom control (📖1) toward **T** (🔍) to view a description of that scene. To return to the original screen, rotate the zoom control toward **T** (🔍) again.

### More Information

See "Basic Menu Operations" (📖10) for more information.

## Changing Scene Mode Settings

- Features That Can Be Set Using the Multi Selector → 55
- Features That Can Be Set Using the **MENU** (Menu) Button
  - Changing the Image Quality and Image Size → 72
  - Setup menu → 103

## Characteristics of Each Scene

- Use of a tripod is recommended in scene modes with indicated due to slow shutter speed.
- Set **Vibration reduction** in the setup menu (103) to **Off** when using a tripod to stabilize the camera.
- For scene modes that use the flash, be sure to press the (flash pop-up) button to raise the flash before shooting (56).

### Night landscape

- Press the **MENU** button to select **Hand-held** or **Tripod** in **Night landscape**.
- **Hand-held** (default setting): This enables you to shoot with the minimum of camera shake and noise even when holding the camera by hand.
  - When the shutter-release button is pressed all the way, pictures are shot continuously, and the camera combines these pictures to save a single picture.
  - Once the shutter-release button is pressed all the way, hold the camera steady without moving it until a still picture is displayed. After taking a picture, do not turn the camera off before the monitor switches to the shooting screen.
  - The angle of view (i.e., the area visible in the frame) seen in the saved image is narrower than that seen on the monitor at the time of shooting.
- **Tripod**: Select this mode when the camera is stabilized, such as with a tripod.
  - Vibration reduction is not used even if **Vibration reduction** in the setup menu (103) is set to **Normal** or **Active**.
  - Press the shutter-release button all the way to shoot a single picture at a slow shutter speed.
- When the shutter-release button is pressed halfway, the camera adjusts the focus to infinity. The focus area or focus indicator (12) always lights in green.

### Landscape



Press the **MENU** button to select **Noise reduction burst** or **Single shot** in **Landscape**.

- **Noise reduction burst:** This enables you to shoot a sharp landscape with a minimum of noise.
  - When the shutter-release button is pressed all the way, pictures are shot continuously, and the camera combines these pictures to save a single picture.
  - Once the shutter-release button is pressed all the way, hold the camera steady without moving it until a still picture is displayed. After taking a picture, do not turn the camera off before the monitor switches to the shooting screen.
  - The angle of view (i.e., the area visible in the frame) seen in the saved image is narrower than that seen on the monitor at the time of shooting.
- **Single shot** (default setting): Records pictures with emphasized outlines and contrast.
  - When the shutter-release button is pressed all the way, one frame is taken.
- When the shutter-release button is pressed halfway, the camera adjusts the focus to infinity. The focus area or focus indicator () always lights in green.

### Backlighting

- Press the **MENU** button to select **HDR** (high dynamic range) composition using the HDR setting.
- When **HDR** is set to **Off** (default setting): The flash fires to prevent the backlit subject from being hidden in shadow. Shoot pictures with the flash raised.
- When **HDR** is set to **Level 1-Level 3**: Use when taking pictures with very bright and dark areas in the same frame. Select **Level 1** when there is less difference between bright and dark areas, and **Level 3** when there is more difference between bright and dark areas.
- The camera focuses at the center area of the frame.

### Notes on HDR











- Use of a tripod is recommended. Set **Vibration reduction** in the setup menu () to **Off** when using a tripod to stabilize the camera.
- The angle of view (i.e., the area visible in the frame) seen in the saved image is narrower than that seen on the monitor at the time of shooting.
- When the shutter-release button is pressed all the way, the camera shoots pictures continuously and saves the following two images.
  - Non-HDR composite image
  - HDR composite image (loss of detail is reduced in highlights and shadows)
  - If there is only enough memory to save one image, one image processed by D-Lighting () at the time of shooting, in which dark areas of the image are corrected, is the only image saved.
- Once the shutter-release button is pressed all the way, hold the camera steady without moving it until a still picture is displayed. After taking a picture, do not turn the camera off before the monitor switches to the shooting screen.
- Depending on the shooting conditions, dark shadows may appear around bright subjects and bright areas may appear around dark subjects. You can compensate by lowering the level setting.
- The digital zoom is not available when **HDR** is set to other than **Off**.



SCENE →  Scene auto selector

When you frame a picture, the camera automatically selects the optimum scene for simpler shooting.

- When the camera automatically selects a scene mode, the shooting mode icon changes to that for the scene mode currently enabled.

	Portrait (close-up picture of one to two persons)
	Portrait (shooting a picture of three or more persons or shooting a composition with a large background area)
	Landscape
	Night portrait (close-up picture of one to two persons)
	Night portrait (shooting a picture of three or more persons or shooting a composition with a large background area)
	Night landscape <ul style="list-style-type: none"> <li>The camera shoots images continuously and combines and saves them as one image in the same way as when <b>Hand-held</b> in  (Night landscape) (p.37) is selected.</li> </ul>
	Close-up
	Backlighting (shooting non-human subjects)
	Backlighting (shooting human subjects)
	Other shooting scenes

- The camera automatically selects the focus area for autofocus in accordance with the composition. The camera detects and focuses on faces (p.80).
- The digital zoom is not available.

 **Note on Selecting a Scene Mode Using Scene Auto Selector**

Depending upon shooting conditions, the camera may not select the desired scene mode. Should this occur, switch to  (auto) mode (p.26) or select the optimum scene mode for the subject manually.

SCENE →  Portrait





- The camera detects and focuses on a face (p.80).
- The skin softening feature makes the subject's skin appear softer (p.46).
- If no faces are detected, the camera focuses on the subject at the center of the frame.
- The digital zoom is not available.

### SCENE → Sports

- The camera focuses at the center area of the frame.
- While you continue to hold the shutter-release button all the way, up to 7 pictures are shot at a rate of about 7 frames per second (fps) (when image quality is set to **Normal** and image size is set to  **4896x3672**).
- The camera focuses on the subject even when the shutter-release button is not pressed halfway. You may hear the sound of the camera focusing.
- Focus, exposure, and hue are fixed at the values determined with the first image in each series.
- The frame rate with continuous shooting may become slow depending upon the current image quality setting, image size setting, the memory card used, or shooting condition.

### SCENE → Night portrait

On the screen that is displayed when  **Night portrait** is selected, select  **Hand-held** or  **Tripod**.

-  **Hand-held**: Select this mode to hold the camera by hand for shooting pictures.
-  **Tripod** (default setting): Select this mode when the camera is stabilized, such as with a tripod.
  - Vibration reduction is not used even if **Vibration reduction** in the setup menu (103) is set to **Normal** or **Active**.
- The camera shoots a single picture at a slow shutter speed. Compared to using **Tripod**, when **Hand-held** is selected the camera sets a slightly faster shutter speed in accordance with the shooting conditions to prevent camera shake.
- The flash always fires. Raise the flash before shooting.
- The camera detects and focuses on a face (80).
- The skin softening feature makes the skin tones in people's faces appear softer (46).
- If no faces are detected, the camera focuses on the subject at the center of the frame.
- The digital zoom is not available.

### SCENE → Party/indoor

- The camera focuses at the center area of the frame.
- As images are easily affected by camera shake, hold the camera steadily. Set **Vibration reduction** to **Off** in the setup menu (103) when shooting using a tripod to stabilize the camera.

### SCENE → Beach

- The camera focuses at the center area of the frame.

### SCENE → Snow

- The camera focuses at the center area of the frame.

SCENE →  Sunset









- When the shutter-release button is pressed halfway, the camera adjusts the focus to infinity. The focus area or focus indicator (12) always lights in green.

SCENE →  Dusk/dawn

- When the shutter-release button is pressed halfway, the camera adjusts the focus to infinity. The focus area or focus indicator (12) always lights in green.

SCENE →  Close-up

Select **Noise reduction burst** or **Single shot** on the screen displayed when  **Close-up** scene mode is selected.

- **Noise reduction burst:** This setting enables you to shoot a sharp picture with a minimum of noise.
  - When the shutter-release button is pressed all the way, pictures are shot continuously, and the camera combines these pictures to save a single picture.
  - Once the shutter-release button is pressed all the way, hold the camera steady without moving it until a still picture is displayed. After taking a picture, do not turn the camera off before the monitor switches to the shooting screen.
  - If the subject moves or there is a significant camera shake during continuous shooting, the image may be distorted, overlapped, or blurred.
  - The angle of view (i.e., the area visible in the frame) seen in the saved image is narrower than that seen on the monitor at the time of shooting.
- **Single shot** (default setting): Records pictures with emphasized outlines and contrast.
  - When the shutter-release button is pressed all the way, one frame is taken.
- The focus mode (62) setting is changed to  (macro close-up) and the zoom is automatically set at a position where the camera can shoot from the closest possible range.
- You can move the focus area that the camera focuses on. Press the  button and then rotate the multi selector or press , ,  or  to move the focus area. To adjust the following settings, press the  button to temporarily cancel focus area selection, and then adjust each setting.
  - Flash mode (when set to **Single shot**)
  - Self-timer
  - Exposure compensation
- The camera focuses on the subject even when the shutter-release button is not pressed halfway. You may hear the sound of the camera focusing.

### SCENE → 🍴 Food

- The focus mode (📖62) setting is changed to 🍷 (macro close-up) and the zoom is automatically set at a position where the camera can shoot from the closest possible range.
- You can adjust the hue by rotating the command dial. The hue adjustment setting is saved in the camera's memory even after the camera is turned off.
- You can move the focus area that the camera focuses on. Press the Ⓞ button and then rotate the multi selector or press ▲, ▼, ◀ or ▶ to move the focus area. To adjust the following settings, press the Ⓞ button to temporarily cancel focus area selection, and then adjust each setting.
  - Hue
  - Self-timer
  - Exposure compensation
- The camera focuses on the subject even when the shutter-release button is not pressed halfway. You may hear the sound of the camera focusing.

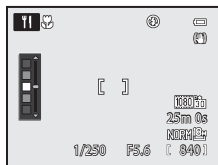

### SCENE → 🏛️ Museum

- The camera focuses at the center area of the frame.
- The camera captures up to 10 images while the shutter-release button is pressed all the way, and the sharpest image in the series is automatically selected and saved (BSS (Best Shot Selector) (📖68)).

### SCENE → 🎆 Fireworks show







- The shutter speed is fixed at 4 seconds.
- The camera focuses at infinity. When the shutter-release button is pressed halfway, the focus indicator (📖12) always lights in green.







### SCENE → 🖼️ Black and white copy

- The camera focuses at the center area of the frame.
- When shooting nearby object, shoot with 🍷 (macro close-up) in the focus mode (📖62).

SCENE →  Panorama

- On the screen that is displayed when  **Panorama** is selected, select  **Easy panorama** or  **Panorama assist**.
- **Easy panorama** (default setting): You can take a panorama picture simply by moving the camera in the desired direction.
  - Shooting range can be selected from **Normal (180°)** (default setting) or **Wide (360°)**.
  - Press the shutter-release button all the way, remove your finger from the button, and then slowly pan the camera horizontally. Shooting automatically ends when the camera captures the specified shooting range.
  - When shooting starts, the camera focuses on the subject at the center area of the frame.
  - The zoom is fixed at the wide-angle position.
  - When the  button is pressed while the picture recorded with Easy panorama is displayed in full-frame playback mode, the camera scrolls the displayed area automatically.

See “Using Easy Panorama (Shooting and Playing back)” (3).

- **Panorama assist**: Use this mode when shooting a series of pictures that can later be joined on a computer to form a single panorama.
  - Press the multi selector , ,  or  to select the direction in which pictures are to be joined and press the  button.
  - After shooting the first picture, shoot the necessary number of pictures while confirming the seams. To finish shooting, press the  button.
  - Transfer taken pictures to a computer and use the Panorama Maker software (89) to join them in a single panorama.

See “Using Panorama Assist” (6) for more information.

### **Note on Printing Panorama Pictures**

When printing panorama pictures, a full view may not be printed depending on the printer settings. Additionally, printing may not be available depending on the printer.

For more information, see your printer's manual or contact a digital photo lab.

### SCENE → 🐾 Pet portrait

- When the camera is pointed at a dog or cat, it detects and focuses on its face. In the default setting, the shutter is automatically released when the camera has focused on the pet (pet portrait auto release).
- On the screen that appears when 🐾 **Pet portrait** is selected, select **Single** or **Continuous**.
  - **Single**: One picture is captured at a time
  - **Continuous**: The camera automatically captures 3 pictures continuously at a rate of about 3 frames per second when it has focused on the detected face. When the shutter is released manually, up to 5 pictures are shot at a rate of about 3 frames per second while you hold the shutter-release button all the way (when image quality is set to **Normal** and image size is set to 📐 **4896×3672**).

### ✔ **Pet Portrait Auto Release**

- To change **Pet portrait auto release** settings, press the multi selector ◀ (📷).
    - 📷: When the camera detects a pet's face, it focuses and then releases the shutter automatically.
    - **OFF**: The camera does not release the shutter automatically, even if a pet's face is detected. Press the shutter-release button to release the shutter. The camera also detects human faces (📖80). When both human and pet's faces are detected, the camera focuses on the pet's face.
  - In the following situations, **Pet portrait auto release** is automatically switched to **OFF**.
    - When a continuous shooting series with pet portrait auto release is repeated 5 times
    - When the internal memory or the memory card is full
- To continue shooting with **Pet portrait auto release**, press the multi selector ◀ (📷) to set again.

### ✔ **Focus Area**

- The detected face is framed by a yellow double border (focus area). When the camera has focused on the face, the double border turns green.
- When the camera detects more than one face of dog or cat (up to 5), the largest face displayed on the monitor is framed by a double border (focus area) and the others by single borders.
- If no human or pet's faces are detected, the camera focuses on the subject at the center of the frame.

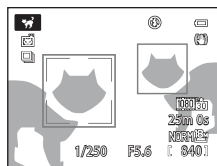

### ✔ **Notes on Pet Portrait**

- The digital zoom is not available.
- Under some shooting conditions, such as subject-to-camera distance, speed of moving pets, direction in which the pets are facing, and brightness of the faces, the camera may be unable to detect a face, or may display a border around something other than a dog or cat.

### ✔ **Viewing Pictures Taken Using Pet Detection**

- During playback, the camera automatically rotates images according to the orientation of the pet's face detected at the time of shooting (except for pictures taken with continuous shooting).
- When zooming in on an image displayed in full-frame playback mode by rotating the zoom control toward **T** (📖), the image is enlarged at the center of a pet's face detected during shooting (📖82) (except for pictures taken with continuous shooting).

## SCENE → 3D 3D photography

- The camera takes one picture for each eye to simulate a three-dimensional image on a 3D-compatible TV or monitor.
- After pressing the shutter-release button to shoot the first frame, move the camera horizontally to the right until the guide on the screen overlaps the subject. The camera automatically captures the second image when it detects that the subject is aligned with the guide.

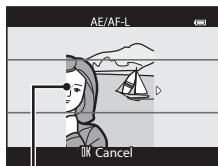

Guide

- You can move the focus area that the camera focuses on. Press the **OK** button and then rotate the multi selector or press **▲**, **▼**, **◀** or **▶** to move the focus area. To adjust the following settings, press the **OK** button to temporarily cancel focus area selection, and then adjust each setting.
  - Focus mode (**AF** (autofocus) or **☛** (macro close-up))
  - Exposure compensation
- The focus, exposure, and white balance are fixed when the first frame is shot, and **AE/AF-L** is displayed on the screen.
- The angle of view (i.e., the area visible in the frame) seen in the saved image is narrower than that seen on the monitor at the time of shooting.
- Pictures taken in this mode are saved with **Normal** as the image quality and **1920×1080** as the image size.
- The two captured images are saved as a 3D image (MPO file). The first image (the left eye image) is also saved as a JPEG file.

### ✓ Notes on 3D Photography

- Moving subjects are not suited to 3D photography.
- Pictures have a less pronounced 3D feel as the distance between the camera and subject is increased.
- Pictures may have a less pronounced 3D feel when the subject is dark or when the second picture is not aligned precisely.
- Pictures taken under dim lighting may appear grainy with noise.
- The telephoto zoom position is restricted to an angle of view equivalent to that of about 135 mm lens in 35mm [135] format.
- The operation is canceled when the **OK** button is pressed after shooting the first frame or the camera cannot detect that the guide is on the subject within 10 seconds.
- If the camera does not take the second picture and cancels the shooting even when you align the guide with the subject, try shooting with the shutter-release button.
- This camera cannot record 3D movies.

### Viewing 3D Photography

- 3D images cannot be played back in 3D on the camera monitor screen. Only the left eye image is displayed during playback.
- To view 3D images in 3D, a 3D-compatible TV or monitor is required. 3D images can be played back in 3D by connecting the camera to a 3D-compatible TV or monitor using a 3D-compatible HDMI cable (📖87).
- When connecting the camera using an HDMI cable, set the following for the **TV settings** in the setup menu (📖103).
  - **HDMI: Auto** (default setting) or **1080i**
  - **HDMI 3D output: On** (default setting)
- When the camera is connected using an HDMI cable for playback, it may take a while to switch the display between 3D images and non-3D images. The images played back in 3D cannot be enlarged.
- See the documentation included with your TV or monitor to perform settings of the TV or monitor.

### Note on Viewing 3D Images

When viewing 3D images on a 3D-compatible TV or monitor for an extended period of time, you may experience discomfort such as eye strain or nausea. Carefully read the documentation included with your TV or monitor to ensure proper use.

## Using Skin Softening

In the following shooting modes, the camera detects up to 3 human faces when the shutter is released, and processes the image to make facial skin tones softer before saving the image.

- **Scene auto selector** (📖39), **Portrait** (📖39) or **Night portrait** (📖40) in scene mode

Skin softening can also be applied to saved images (📖84).

### Notes on Skin Softening

- It may take more time to save images.
- Under some shooting conditions, the desired skin softening results may not be achieved, and skin softening may be applied to areas of the image where there are no faces.



## Special Effects Mode (Applying Effects When Shooting)

The effect can be applied to pictures during shooting. One of the special effects is selected to shoot.

To select an effect, press the **MENU** button to display the special effects menu.

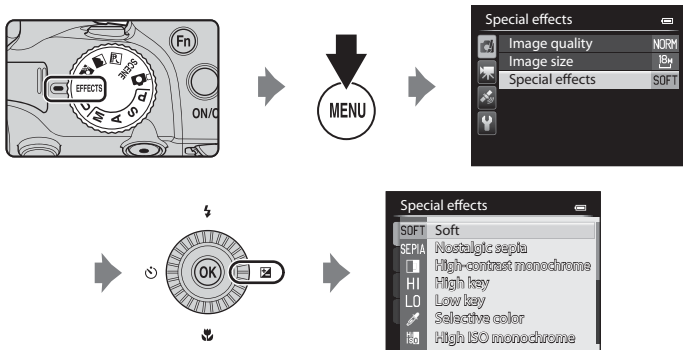

- The camera focuses at the center area of the frame.

Option	Description
Soft (default setting)	Soften the image by adding a slight blur to the overall image.
Nostalgic sepia	Add a sepia tone and reduces the contrast to simulate the qualities of an old photograph.
High-contrast monochrome	Create a black-and-white photograph with a clear contrast.
High key	Give the overall image a bright tone.
Low key	Give the overall image a dark tone.

## Special Effects Mode (Applying Effects When Shooting)

Option	Description
Selective color	<p>Create a black and white image in which only the specified color remains.</p> <ul style="list-style-type: none"><li>Select a color that you want to retain from the slider by rotating the command dial. To adjust the following settings, press the <b>OK</b> button to temporarily cancel color selection, and then adjust each setting.<ul style="list-style-type: none"><li>Flash mode (📖56)</li><li>Self-timer (📖59)</li><li>Focus mode (📖62)</li><li>Exposure compensation (📖64)</li></ul></li></ul> <p>To return to the color selection screen, press the <b>OK</b> button again.</p>
High ISO monochrome	<p>Create monotone (black and white) pictures by intentionally taking pictures with high ISO sensitivity. This setting is effective when shooting subjects in low lighting conditions.</p> <ul style="list-style-type: none"><li>The pictures taken may contain noise (randomly-spaced bright pixels, fog or lines).</li></ul>
Silhouette	<p>Create a silhouette photograph of a subject with a bright background.</p>
Cross process	<p>Create images with an unusual hue by converting a positive color image into negative or negative color image into positive.</p> <ul style="list-style-type: none"><li>Rotate the command dial to select hue.</li></ul>

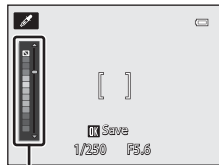

Slider

### ✔ Special Effects Mode Settings

When **Movie options** (📖96) is set to **480i/20/480i/100 HS 480/4x, Soft** or **Nostalgic sepia** cannot be selected.

### 📝 More Information

See "Basic Menu Operations" (📖10) for more information.

### Changing Special Effects Mode Settings

- Features That Can Be Set Using the Multi Selector → 📖55
- Features That Can Be Set Using the **MENU** (Menu) Button
  - Changing the Image Quality and Image Size → 📖72
  - Setup menu → 📖103

## P, S, A, M Modes (Setting the Exposure for Shooting)

Pictures can be shot with greater control by setting the shooting menu (📖67) items in addition to setting the shutter speed or aperture value manually according to shooting conditions and requirements.

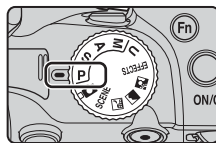

- The focus area for autofocus differs depending on the setting of **AF area mode** that can be selected in the **P, S, A** or **M** tab after pressing the **MENU** button.
- The camera has 9 focus areas, and when **AF area mode** is set to **Auto** (default setting), it automatically selects the focus areas containing the subject closest to the camera. When the subject is in focus, the focus areas that are in focus (up to 9 areas) light in green.

The procedure for shooting pictures at the desired brightness (exposure) by adjusting the shutter speed or aperture value is called “determine exposure.” The sense of dynamism and amount of background defocus in pictures to be shot vary depending on the combinations of shutter speed and aperture value even if the exposure is the same.

Rotate the command dial or multi selector to set the shutter speed and aperture value.

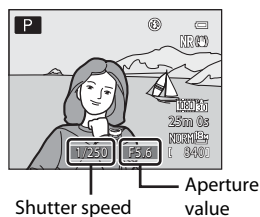
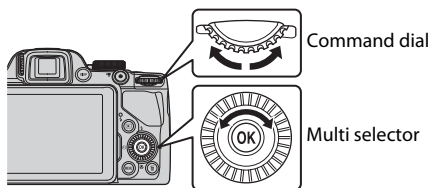

Exposure mode	Shutter speed (📖78)	Aperture value (📖50)
<b>P</b> Programmed auto (📖51)	Automatically adjusted (flexible program is enabled by the command dial).	
<b>S</b> Shutter-priority auto (📖51)	Adjusted by the command dial.	Automatically adjusted.
<b>A</b> Aperture-priority auto (📖51)	Automatically adjusted.	Adjusted by the multi selector.
<b>M</b> Manual (📖51)	Adjusted by the command dial.	Adjusted by the multi selector.

The setting method of the flexible program, shutter speed, and aperture value can be changed using the **Toggle Av/Tv selection** in the setup menu (📖103).

## **P, S, A, M** Modes (Setting the Exposure for Shooting)

### **Adjusting the Shutter Speed**

In **S** or **M** mode, the range is from a maximum of 1/4000 to 8 seconds.

See “The Control Range of the Shutter Speed (**P, S, A, M** Modes)” (📖78) for more information.



Faster 1/1000 s



Slower 1/30 s

### **Adjusting the Aperture Value**

In **A** and **M** modes, the range is from f/3 to 8.3 (wide-angle position) and from f/5.9 to 8.3 (telephoto zoom position).



Larger aperture (Small f-number)  
f/3



Smaller aperture (Large f-number)  
f/8.3

### **Aperture Value (F-number) and Zoom**

Large apertures (expressed by small f-numbers) let more light into the camera, and small apertures (large f-numbers) let less light.

The aperture value of the zoom lens of this camera changes depending on the zoom position. When zooming to the wide-angle position and telephoto zoom position, the aperture values are f/3 and f/5.9, respectively.

### **U (User settings) Mode**

Even when the mode dial is set to **U** (User settings) mode, you can shoot in **P** (Programmed auto), **S** (Shutter-priority auto), **A** (Aperture-priority auto) or **M** (Manual). The setting combinations (User settings) that are frequently used for shooting can be saved in **U** (📖54).

## P (Programmed auto)

Use for automatic control of the exposure by the camera.

- Different combinations of shutter speed and aperture value can be selected without changing the exposure by rotating the command dial (“flexible program”). While flexible program is in effect, a flexible program mark (**⌘**) is displayed next to the mode indicator (**P**) in the upper left of the monitor screen.
- To cancel the flexible program, rotate the command dial until the flexible program mark (**⌘**) is no longer displayed. Selecting another shooting mode, or turning off the camera, also cancels flexible program.

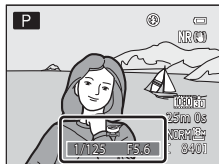

## S (Shutter-priority auto)

Use to shoot fast moving subjects with a fast shutter speed, or use to emphasize the movements of a moving subject with a slow shutter speed.

- The shutter speed can be adjusted by rotating the command dial.

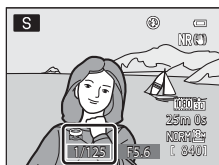

## A (Aperture-priority auto)

Use to bring subjects including both the foreground and background into focus or blur the subject's background intentionally.

- The aperture value can be adjusted by rotating the multi selector.

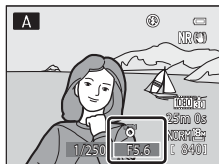

## M (Manual)

Use to control the exposure according to shooting requirements.

- When adjusting the aperture value or shutter speed, the degree of deviation from the exposure value measured by the camera is displayed in the exposure indicator of the monitor screen. The degree of deviation in the exposure indicator is displayed in EVs (-2 to +2 EV in increments of 1/3 EV).
- The shutter speed can be adjusted by rotating the command dial and the aperture value can be adjusted by rotating the multi selector.

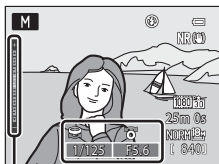

Exposure indicator

## P, S, A, M Modes (Setting the Exposure for Shooting)

### ✔ Notes on Shooting

- When zooming is performed after the exposure is set, exposure combinations or aperture value may be changed.
- When the subject is too dark or too bright, it may not be possible to obtain the appropriate exposure. In such cases, the shutter speed indicator or aperture value indicator flashes when the shutter-release button is pressed halfway (except when the **M** mode is used). Change the shutter speed setting or aperture value. When settings such as **ISO sensitivity** (📖69) are changed, the appropriate exposure may be obtained.

### ✔ Note on ISO Sensitivity

When **ISO sensitivity** (📖69) is set to **Auto** or **Fixed range auto**, the ISO sensitivity in **M** mode is fixed at ISO 80.

## Changing P, S, A, M Modes

- Features That Can Be Set Using the Multi Selector → 📖55
- Features That Can Be Set Using the **MENU** (Menu) Button
  - Shooting menu → 📖67
  - Setup menu → 📖103
- Functions That Can Be Set Using the Fn (Function) Button → 📖71

## U (User Setting Modes)

Setting combinations that are frequently used for shooting (User settings) can be saved in **U**. Shooting is possible in **P** (Programmed auto), **S** (Shutter-priority auto), **A** (Aperture-priority auto) or **M** (Manual).

Rotate the mode dial to **U** to retrieve the settings saved in **Save user settings**.

See “Saving Settings in **U** Mode” (📖54) for more information.

- Frame the subject and shoot with these settings, or change the settings as required.

- The setting combinations that are retrieved when the mode dial is rotated to **U** can be changed as many times as you want in **Save user settings**.

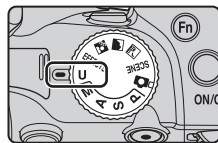

The following settings can be stored in **U**.

### General setup

- Shooting mode **P**, **S**, **A** or **M** (📖49)<sup>1</sup>
- Focus mode (📖62)<sup>3</sup>
- Zoom position (📖29)<sup>2</sup>
- Exposure compensation (📖64)
- Flash mode (📖56)
- Fn button (📖71)
- Self-timer (📖59)

### Shooting menu

- Image quality (📖72)
- Exposure bracketing (📖69)
- Image size (📖73)
- AF area mode (📖69)<sup>5</sup>
- Picture Control (📖68)
- Autofocus mode (📖69)
- Custom Picture Control (📖68)
- Flash exp. comp. (📖69)
- White balance (📖68)<sup>4</sup>
- Noise reduction filter (📖69)
- Metering (📖68)
- Active D-Lighting (📖69)
- Continuous (📖68)
- Zoom memory (📖69)
- ISO sensitivity (📖69)

<sup>1</sup> Choose the standard shooting mode. The current flexible program (when set to **P**), shutter speed (when set to **S** or **M**) or aperture value (when set to **A** or **M**) settings will also be saved.

<sup>2</sup> The current zoom position will also be saved. **Startup zoom position** (📖69) cannot be set.

<sup>3</sup> The current focus distance will also be saved when set to **MF** (manual focus).

<sup>4</sup> The preset value for preset manual applies commonly to **P**, **S**, **A**, **M** and **U** shooting modes.

<sup>5</sup> The current focus area position is saved when **AF area mode** is set to **Manual**.

### Saving Settings in U Mode

**1** Rotate the mode dial to the desired exposure mode.

- Rotate to **P**, **S**, **A** or **M**.
- Settings can be saved even if rotated to **U** (the default settings of shooting mode **P** are saved when the camera is first purchased).

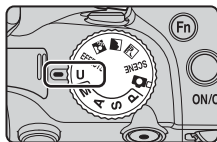

**2** Change to a frequently used combination of shooting settings.

- See [□53](#) for more information about the saved settings.

**3** Press the **MENU** button.

- The shooting menu is displayed.

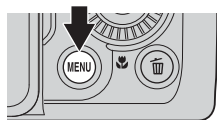

**4** Use the multi selector to select **Save user settings**, and press the **OK** button.

- **Done** screen is displayed, and the current settings are saved.

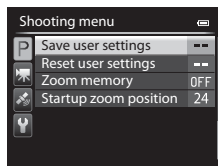

#### **Clock Battery**

If the internal clock battery ([□25](#)) is exhausted, the settings saved in **U** will be reset. Writing down any important setting is recommended.

#### **Resetting for User Settings**

If **Reset user settings** is selected, the settings that are saved in the user settings are reset as follows:

- Shooting mode: **P** (Programmed auto)
- Zoom position: Maximum wide-angle position
- Flash mode: **SAUTO** (auto)
- Focus mode: **AF** (autofocus)
- Exposure compensation: 0.0
- Fn button: **Continuous**
- Shooting menu: Same as the default setting for each item



## Features That Can Be Set Using the Multi Selector

Press the multi selector () , () , () or () while shooting to operate the following functions.

Self-timer (📖59)/  
Smile timer (📖60)

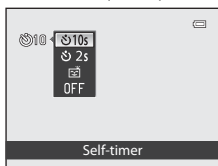

Flash mode (📖56)

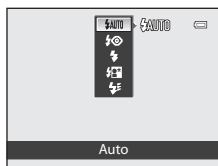

Focus mode (📖62)

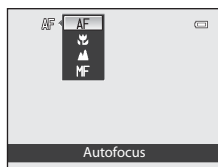

Exposure compensation (📖64)

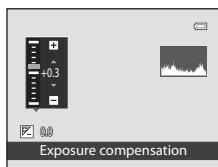

## Available Functions

Available functions differ according to the shooting mode as follows.

- See "List of the Default Settings" (📖65) for more information on the default settings in each shooting mode.

Function		SCENE	EFFECTS	P, S, A, M, U
Flash mode (📖56)	✓	1	1	✓
Self-timer (📖59)	✓		✓	✓
Smile timer (📖60)	✓		-	✓
Focus mode (📖62)	✓		✓	✓
Exposure compensation (📖64)	✓		✓	✓ <sup>2</sup>

1 The setting varies with scene mode or special effects. See "List of the Default Settings" (📖65) for more information.

2 When the shooting mode is **M**, exposure compensation cannot be used.

## Using the Flash (Flash Modes)

You can shoot pictures with a flash by raising the flash. You can set a flash mode that suits the shooting conditions.

### 1 Press the (flash pop-up) button to raise the flash.

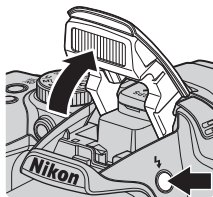

- When the flash is lowered, flash operation is disabled and  is displayed.



### 2 Press (flash mode) on the multi selector.



### 3 Use the multi selector to select the desired mode and press the button.

- See “Available Flash Modes” (157) for more information.
- If the  button is not pressed within a few seconds, the selection will be canceled.
- When  (auto) is applied,  is only displayed for a few seconds even if monitor indicators (19) are turned on.

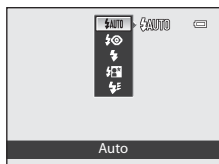

### 4 Frame the subject and take a picture.

- The flash lamp indicates the status of the flash when the shutter-release button is pressed halfway.
  - On: The flash will fire when you press the shutter-release button all the way.
  - Flashing: The flash is charging. The camera cannot take pictures.
  - Off: The flash will not fire when a picture is taken.
- If the battery is low, the monitor will be turned off while the flash is charging.

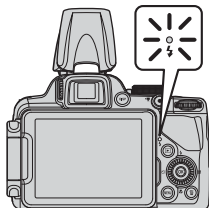

## Available Flash Modes



### Auto

Flash fires automatically when lighting is dim.



### Auto with red-eye reduction

Best choice for portraits. Reduces red-eye effect caused by flash in portraits (📖58).



### Fill flash

The flash fires when a picture is taken, regardless of how bright the subject is. Use to “fill-in” (illuminate) shadows and backlit subjects.



### Slow sync

Fill flash is combined with a slow shutter speed. Suitable for portraits of human subjects shot at night or under dim light. Flash illuminates main subject; slow shutter speeds are used to capture background.



### Rear-curtain sync

Fill flash fires just before the shutter closes, creating the effect of a stream of light behind moving subjects.



### Lowering the Flash

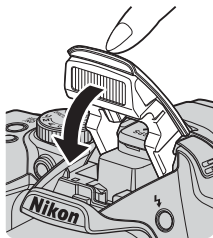

When not using the flash, gently push to lower the flash until it clicks shut.



### Effective Range of the Flash

The flash has a range of about 0.5 to 8.0 m (1 ft 8 in. to 26 ft) for wide-angle position, and about 1.5 to 4.5 m (5 ft to 14 ft) for telephoto zoom position (when **ISO sensitivity** is set to **Auto**).

### **Flash Mode Setting**

- The setting varies with shooting mode. See “Available Functions” (📖65) and “List of the Default Settings” (📖65) for more information.
- Some features cannot be used in combination with other menu settings. See “Features Not Available in Combination” (📖75) for more information.
- The changed flash mode setting applied in the following situations is saved in the camera’s memory even after the camera is turned off.
  - When shooting mode **P**, **S**, **A** or **M** is used
  - When  (auto with red-eye reduction) is selected in  (auto) mode

### **Auto with Red-eye Reduction**

This camera uses **advanced red-eye reduction (“In-Camera Red-Eye Fix”)**.

If the camera detects “red-eye” when a picture is taken, Nikon’s own In-Camera Red-Eye Fix processes the image before it is recorded.

Note the following when taking pictures:

- The time required to save the picture increases slightly.
- Advanced red-eye reduction may not produce the desired results in some situations.
- In extremely rare instances, areas not subject to red-eye may be affected by advanced red-eye reduction processing. In these cases, choose another mode and try again.

## Using the Self-timer

The self-timer is suitable for taking group shots including yourself and reducing the vibration when the shutter-release button is pressed.

When using the self-timer, use of a tripod is recommended. Set **Vibration reduction** in the setup menu (📖103) to **Off** when using a tripod to stabilize the camera.

- 1** Press ◀ (🕒 self-timer) on the multi selector.

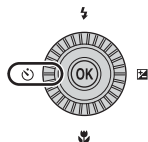

- 2** Use the multi selector to select 🕒10s (or 🕒2s) and press the OK button.

- 🕒10s (10 seconds): suitable for group pictures.
- 🕒2s (2 seconds): suitable for preventing camera shake.
- When the shooting mode is set to **Pet portrait** in scene mode, 📷 (pet portrait auto release) is displayed (📖44). The self-timer is not available.
- The mode selected for the self-timer is displayed.
- If the OK button is not pressed within a few seconds, the selection will be canceled.

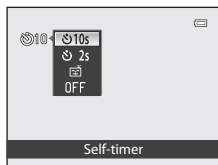

- 3** Frame the picture and press the shutter-release button halfway.

- Set the focus and exposure.

- 4** Press the shutter-release button all the way.

- The self-timer starts, and the number of seconds remaining before the shutter is released is displayed. The self-timer lamp flashes while the timer is counting down. About one second before the shutter is released, the lamp stops flashing and remains lit.
- When the shutter is released, the self-timer turns **OFF**.
- To stop the timer before a picture is taken, press the shutter-release button again.

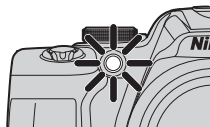
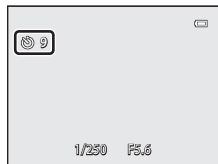

## Shooting Smiling Faces Automatically (Smile Timer)

When this mode is selected, the camera detects smiling faces and automatically releases the shutter even if you do not press the shutter-release button.

- This function can be used when the shooting mode is (auto), **P**, **S**, **A**, **M**, **U**, scene mode **Portrait** or **Night portrait**.

### 1 Press (self-timer) on the multi selector.

- Change any flash mode, exposure, or shooting menu settings before pressing .

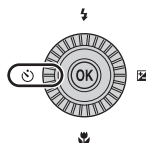

### 2 Use the multi selector to choose (smile timer), and press the button.

- If the button is not pressed within a few seconds, the selection will be canceled.

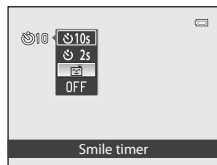

### 3 Frame the picture and wait for the subject to smile without pressing the shutter-release button.

- When the camera detects a face, a yellow double border (focus area) is displayed around that face. When the camera focuses on that face, the double border will turn green for a moment and focus is locked.
- Up to 3 faces are detected. When more than one face is detected, the face closest to the center of the frame is framed by a double border and the others by single borders.
- If the camera detects that the face framed by the double border is smiling, the shutter is automatically released.
- Each time the shutter is released, automatic shooting using face detection and smile detection is repeated.

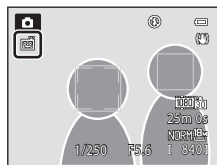

### 4 Finish shooting.

- To cancel smile detection and finish shooting, return to step 1 and select **OFF**.

### **Notes on Smile Timer**

- The digital zoom is not available.
- Under some shooting conditions, faces and smiling faces may not be detected properly.
- See “Viewing Pictures Taken Using Face Detection” (📖80) for more information.
- The smile timer cannot be used simultaneously with certain shooting modes. See “Available Functions” (📖55) and “List of the Default Settings” (📖65) for more information.
- Some features cannot be used in combination with other menu settings. See “Features Not Available in Combination” (📖75) for more information.

### **When the Self-timer Lamp Flashes**

When the camera detects a face, the self-timer lamp flashes. The lamp quickly flashes immediately after the shutter is released.

### **Releasing the Shutter Manually**

The shutter can also be released by pressing the shutter-release button. If no faces are detected, the camera focuses on the subject at the center area of the frame.

### **More Information**

See “Autofocus” (📖81) for more information.

## Using Focus Mode

Choose a focus mode according to the desired scene.

- 1 Press ▼ (👇 focus mode) on the multi selector.

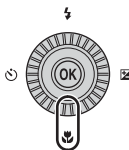

- 2 Use the multi selector to choose the desired focus mode and press the OK button.

- See "Available Focus Modes" (📖63) for more information.
- If the OK button is not pressed within a few seconds, the selection will be canceled.
- When AF (autofocus) is applied, AF is only displayed for a few seconds even if monitor indicators (📖9) are turned on.

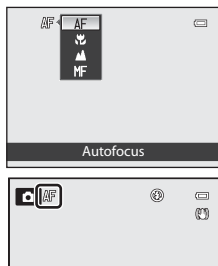





## Available Focus Modes

### AF Autofocus

The camera automatically adjusts the focus according to the distance to the subject. Use when the distance from the subject to the lens is 50 cm (1 ft 8 in.) or more, or 2.0 m (6 ft 7 in.) or more at the maximum telephoto zoom position.

### Macro close-up

Use for close-ups of flowers or small objects. How close you can be to the subject while shooting depends on the zoom position. At the zoom position where  and the zoom indicator light in green, the camera can focus on subjects as close as about 10 cm (4 in.) or farther from the lens. At the  zoom position, it can focus on subjects as close as about 1 cm (0.4 in.) or farther from the lens.

### Infinity

Use when shooting distant scenes through window glass or when shooting landscapes. The camera automatically adjusts the focus near infinity.

- The camera may not be able to focus on nearby objects.
- The flash does not fire.

### MF Manual focus



The focus can be adjusted for any subject that is a distance of 1 cm (0.4 in.) to infinity from the lens (2). The closest distance at which the camera can focus varies depending on the zoom position.

- This function can be used when the shooting mode is **P**, **S**, **A**, **M**, **U**, special effects mode or **Sports** scene mode.



## Note on Shooting with the Flash

The flash may be unable to light the entire subject at distances of less than 50 cm (1 ft 8 in.).

## Focus Mode Setting

- The setting varies with the shooting mode. See “Available Functions” (55) and “List of the Default Settings” (65) for more information.
- Some features cannot be used in combination with other menu settings. See “Features Not Available in Combination” (75) for more information.
- For shooting modes **P**, **S**, **A** and **M**, the changed focus mode setting is saved in the camera’s memory even after the camera is turned off.

## Macro Close-up

In shooting modes such as scene modes that cannot use the **Autofocus mode** (69), **Full-time AF** may be turned on and the camera will adjust focus even if the shutter-release button is not pressed halfway when  (macro close-up) is set. You may hear a sound of the camera focusing.

## Adjusting Brightness (Exposure Compensation)

By adjusting exposure compensation when taking pictures, you can adjust overall image brightness.

- 1 Press **▶** (☑ exposure compensation) on the multi selector.

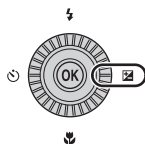

- 2 Press the multi selector **▲** or **▼** to select a compensation value.

Setting	Explanation
"+" side	Make the subject brighter than the exposure set by the camera.
"-" side	Make the subject darker than the exposure set by the camera.
"0.0"	Cancel the exposure compensation.

Exposure compensation guide

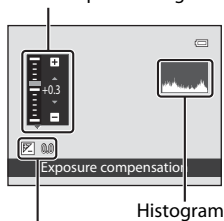

Exposure compensation value

- 3 Press the **OK** button.

- If the **OK** button is not pressed within a few seconds, the selection is set and the setting menu disappears.
- Even when the shutter-release button is pressed without pressing the **OK** button, a picture can be shot using the selected compensation value.
- When an exposure compensation value other than **0.0** is applied, the value is displayed with the ☑ icon on the monitor screen.

- 4 Press the shutter-release button to take a picture.

- To turn off exposure compensation, return to step 1 and change the value to **0.0**.



### Exposure Compensation Value

- The changed exposure compensation value applied in **P**, **S** or **A** mode is saved in the camera's memory even after the camera is turned off.
- When the shooting mode is the **Fireworks show** scene mode (📖42) or **M** (Manual) (📖51), the exposure compensation cannot be used.
- When the exposure compensation is set while using a flash, the compensation is applied to both the background exposure and to the flash output.

## Using the Histogram











A histogram is a graph showing the distribution of tones in the image. Use as a guide when using exposure compensation and shooting without the flash.

- The horizontal axis corresponds to pixel brightness, with dark tones to the left and bright tones to the right. The vertical axis shows the number of pixels.
- Increasing exposure compensation value shifts tone distribution to the right, and decreasing it shifts tone distribution to the left.

## List of the Default Settings

The default settings in each shooting mode are described below.

- Similar information about scene mode can be found on the next page.

Shooting mode	Flash mode <sup>1</sup> (  56)	Self-timer (  59)	Focus mode (  62)	Exposure compensation (  64)
 (Auto) (  35)	 AUTO	OFF <sup>2</sup>	AF <sup>3</sup>	0.0
<b>EFFECTS</b> (Special effects) (  47)	 <sup>4</sup>	OFF	AF	0.0
<b>P, S, A, M</b> (  49)	 AUTO	OFF <sup>2</sup>	AF	0.0
<b>U</b> (User settings) (  53)	 AUTO	OFF <sup>2</sup>	AF	0.0

<sup>1</sup> When the flash is lowered, you cannot set a flash mode.

<sup>2</sup> Smile timer can also be selected.

<sup>3</sup> **MF** (manual focus) cannot be selected.

<sup>4</sup> The flash does not fire when **High ISO monochrome** or **Silhouette** is selected.



















- The setting applied in shooting modes **P**, **S**, **A** and **M** is saved in the camera's memory even after the camera is turned off (except for self-timer).

## Features Not Available in Combination

Some features cannot be used in combination with other menu settings (75).

## Features That Can Be Set Using the Multi Selector

The default settings in scene mode are described below.

	Flash mode <sup>1</sup> (📖56)	Self-timer (📖59)	Focus mode (📖62)	Exposure compensation (📖64)
 (📖37)	🔆 <sup>2</sup>	OFF	▲ <sup>2</sup>	0.0
 (📖38)	🔆 <sup>2</sup>	OFF	▲ <sup>2</sup>	0.0
 (📖38)	🔆/🔆 <sup>3</sup>	OFF	AF <sup>2</sup>	0.0
 (📖39)	🔆AUTO <sup>4</sup>	OFF	AF <sup>2</sup>	0.0
 (📖39)	🔆👁️	OFF <sup>5</sup>	AF <sup>2</sup>	0.0
 (📖40)	🔆 <sup>2</sup>	OFF <sup>2</sup>	AF <sup>6</sup>	0.0
 (📖40)	🔆👁️ <sup>7</sup>	OFF <sup>5</sup>	AF <sup>2</sup>	0.0
 (📖40)	🔆👁️ <sup>8</sup>	OFF	AF <sup>2</sup>	0.0
 (📖40)	🔆AUTO	OFF	AF <sup>9</sup>	0.0
 (📖40)	🔆AUTO	OFF	AF <sup>9</sup>	0.0
 (📖41)	🔆 <sup>2</sup>	OFF	▲ <sup>2</sup>	0.0
 (📖41)	🔆 <sup>2</sup>	OFF	▲ <sup>2</sup>	0.0
 (📖41)	🔆 <sup>10</sup>	OFF	🌸 <sup>2</sup>	0.0
 (📖42)	🔆 <sup>2</sup>	OFF	🌸 <sup>2</sup>	0.0
 (📖42)	🔆 <sup>2</sup>	OFF	AF <sup>9</sup>	0.0
 (📖42)	🔆 <sup>2</sup>	OFF <sup>2</sup>	▲ <sup>2</sup>	0.0 <sup>2</sup>
 (📖42)	🔆	OFF	AF <sup>9</sup>	0.0
 (📖43)	🔆 <sup>11</sup>	OFF <sup>11</sup>	AF <sup>12</sup>	0.0
 (📖44)	🔆 <sup>2</sup>	📷 <sup>13</sup>	AF <sup>9</sup>	0.0
3D (📖45)	🔆 <sup>2</sup>	OFF <sup>2</sup>	AF <sup>9</sup>	0.0

<sup>1</sup> When the flash is lowered, you cannot set a flash mode.

<sup>2</sup> The setting cannot be changed.

<sup>3</sup> Flash is fixed at 🔆 (fill flash) when **HDR** is set to **Off**, and does not fire when **HDR** is set to other than **Off**.

<sup>4</sup> The setting cannot be changed. The camera automatically selects the flash mode appropriate for the scene it has selected.

<sup>5</sup> Smile timer can also be selected.

<sup>6</sup> **AF** (autofocus) or **MF** (manual focus) can be selected.

<sup>7</sup> The setting cannot be changed. The flash mode setting is fixed at fill flash with slow sync and red-eye reduction.

<sup>8</sup> May switch to slow sync with red-eye reduction flash mode.

<sup>9</sup> **AF** (autofocus) or 🌸 (macro close-up) can be selected.

<sup>10</sup> Flash does not fire when using **Noise reduction burst**.

<sup>11</sup> The setting cannot be changed when using **Easy panorama**.

<sup>12</sup> The setting cannot be changed when using **Easy panorama**. **AF** (autofocus), 🌸 (macro close-up) or ▲ (infinity) can be selected when using **Panorama assist**.

<sup>13</sup> Pet portrait auto release (📖44) can be set to on or off. The self-timer is not available.

## Features That Can Be Set Using the MENU (Menu) Button (Shooting Mode)

The shooting menu can be set by pressing the **MENU** button in shooting mode.

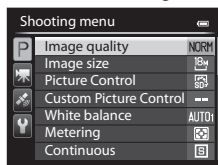
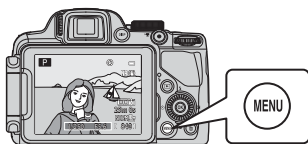

Available functions differ according to the shooting mode.

Function		P, S, A, M, U	SCENE <sup>1</sup> 	EFFECTS <sup>2</sup>
Image quality (📖72)	✓	✓	✓	✓
Image size (📖73)	✓	✓	✓	✓
Picture Control (📖68)	-	✓	-	-
Custom Picture Control (📖68)	-	✓	-	-
White balance (📖68)	-	✓	-	-
Metering (📖68)	-	✓	-	-
Continuous (📖68)	-	✓	-	-
ISO sensitivity (📖69)	-	✓	-	-
Exposure bracketing (📖69)	-	✓	-	-
AF area mode (📖69)	-	✓	-	-
Autofocus mode (📖69)	-	✓	-	-
Flash exp. comp. (📖69)	-	✓	-	-
Noise reduction filter (📖69)	-	✓	-	-
Active D-Lighting (📖69)	-	✓	-	-
Save user settings (📖69)	-	✓	-	-
Reset user settings (📖69)	-	✓	-	-
Zoom memory (📖69)	-	✓	-	-
Startup zoom position (📖69)	-	✓ <sup>3</sup>	-	-

<sup>1</sup> When the mode dial is set to **SCENE**, the type of scene can be selected. Other settings can be selected in some scene modes. See “Characteristics of Each Scene” (📖37) for more information.

<sup>2</sup> The type of effects can be selected in **Special effects** mode. See 📖47 for more information.

<sup>3</sup> This function cannot be set when using **U** mode.











### Features Not Available in Combination

Some features cannot be used in combination with other menu settings (📖75).

















### More Information

See “Basic Menu Operations” (📖10) for more information.

## Options Available in the Shooting Menu

Option	Description	
Image quality <sup>1</sup>	Set the image quality to be recorded (compression ratio) (  72). The default setting of image quality is <b>Normal</b> .	72
Image size <sup>1</sup>	Set the image size to be recorded (  73). The default setting is  <b>4896x3672</b> .	73
Picture Control <sup>1</sup> (COOLPIX Picture Control)	Change the settings for image recording according to the shooting scene or your preferences. The default setting is <b>Standard</b> .	 26
Custom Picture Control (COOLPIX Custom Picture Control)	Allow you to store the customized settings based in COOLPIX Picture Control, which can set picture editing options for recording images according to the shooting scene or your preferences.	 30
White balance <sup>1</sup>	Adjust colors in the image closer to the colors as they appear to the eye. Although <b>Auto (normal)</b> (default setting) can be used under most types of lighting, you can apply the white balance setting suited to the sky conditions or light source to achieve better results if the default setting results are unsatisfactory. <ul style="list-style-type: none"> <li>The preset value for preset manual applies commonly to <b>P, S, A, M</b> and <b>U</b> shooting modes.</li> </ul>	 31
Metering <sup>1</sup>	Select the method that the camera uses to measure the brightness of the subject. The camera adjusts the exposure, which is a combination of shutter speed and aperture value, based on the brightness measurement. The default setting is <b>Matrix</b> .	 33
Continuous <sup>1</sup>	Set the mode used for taking a series of pictures. <ul style="list-style-type: none"> <li>The default setting is <b>Single</b> (i.e., only one picture is captured at a time).</li> <li>When <b>Continuous H, Continuous L, Pre-shooting cache</b> or <b>BSS</b> (42) is set, the pictures are shot continuously while the shutter-release button is pressed all the way.</li> <li>If <b>Continuous H: 120 fps, Continuous H: 60 fps</b> or <b>Multi-shot 16</b> is set, the specified number of pictures are shot continuously when the shutter-release button is pressed all the way.</li> <li>If the <b>Intvl timer shooting</b> is set, the pictures are shot continuously at the set interval of <b>30 s, 1 min, 5 min</b> or <b>10 min</b> when the shutter-release button is pressed all the way once.</li> </ul>	 34

## Features That Can Be Set Using the MENU (Menu) Button (Shooting Mode)

Option	Description	
ISO sensitivity <sup>1</sup>	Higher ISO sensitivity allows you to take pictures of darker subjects. Additionally, even with subjects of similar brightness, pictures can be taken at faster shutter speeds, and blurring caused by camera shake and subject movement can be reduced. When ISO sensitivity is set to <b>Auto</b> (default setting), the camera sets the ISO sensitivity automatically. <ul style="list-style-type: none"> <li>In <b>M</b> (Manual) mode, ISO sensitivity is fixed at ISO 80 if <b>Auto</b> or <b>Fixed range auto</b> is selected.</li> </ul>	 38
Exposure bracketing	The exposure (brightness) can be changed automatically during continuous shooting. The default setting is <b>Off</b> .	 39
AF area mode <sup>1</sup>	Set how the camera determines the focus area using the autofocus to <b>Face priority</b> (  80), <b>Auto</b> , <b>Manual</b> , <b>Center (normal)</b> , <b>Center (wide)</b> , <b>Subject tracking</b> or <b>Target finding AF</b> (  79).	 40
Autofocus mode	When <b>Single AF</b> (default setting) is selected, the camera focuses only while the shutter-release button is pressed halfway. When <b>Full-time AF</b> is selected, the camera focuses even when the shutter-release button is not pressed halfway. You may hear the sound of the camera focusing.	 44
Flash exp. comp.	Adjust the flash output. Use this option when the flash is too bright or too dark. The default setting is <b>0.0</b> .	 45
Noise reduction filter	Set the strength of the noise reduction function that is normally performed when recording the picture. The default setting is <b>Normal</b> .	 45
Active D-Lighting	Prevent loss of contrast details in highlights and shadows when shooting images. The default setting is <b>Off</b> .	 46
Save user settings	The current settings are stored in mode dial <b>U</b> (  53).	53
Reset user settings	The settings saved to mode dial <b>U</b> are reset.	54
Zoom memory	If the zoom control is operated when set to <b>On</b> , the camera changes in steps to the focal length (equivalent to 35mm [135] format of angle of view) of the zoom lens that is set in advance. The default setting is <b>Off</b> . <ul style="list-style-type: none"> <li>Select <b>On</b> and press the  button to display the screen for focal length selection. Press the  button to switch the On []/Off setting, then press the multi selector  to apply the selection.</li> </ul>	 47
Startup zoom position <sup>2</sup>	When the camera is turned on, the zoom position moves to the focal length (equivalent to 35mm [135] format of angle of view) of the zoom lens that is set in advance. The default setting is <b>24 mm</b> .	 47

## Features That Can Be Set Using the MENU (Menu) Button (Shooting Mode)

- <sup>1</sup> If this function is assigned to the **Fn** (function) button using **Fn button**, its setting menu can be also displayed on the screen by pressing the **Fn** (function) button during shooting. See  71 for more information on using the Fn (function) button.
- <sup>2</sup> This function cannot be set when using **U** mode.



# Functions That Can Be Set Using the Fn (Function) Button

The following functions can be also set by pressing the **Fn** (function) button instead of displaying the corresponding menu by pressing the **MENU** button.

- This feature can be used when the shooting mode is **P**, **S**, **A**, **M** or **U**.

Image quality (📖72)	Continuous (📖68)
Image size (📖73)	ISO sensitivity (📖69)
Picture Control (📖68)	AF area mode (📖69)
White balance (📖68)	Vibration reduction (📖104)
Metering (📖68)	

## 1 Press the **Fn** (function) button when the shooting screen is displayed.

- The **Fn** **Fn** button function menu and the setting items of the function (default setting is **Continuous**) that was last assigned to the **Fn** (function) button are displayed.



## 2 Use the multi selector to select the menu item.

- To assign another function, select the **Fn** **Fn** button function menu and press the **OK** button. Then, select the desired function from the displayed menu.



## 3 After you finish assigning the function, press the **OK** button or **Fn** (function) button.

- The camera returns to the shooting screen.

## Changing the Image Quality and Image Size

The image quality (compression ratio) and image size can be selected for recording.

### Image Quality

With a higher image quality setting, a higher detail of image expression is retained, but the number of images that can be saved (📖74) is reduced because the file size also becomes larger.

Display the shooting screen → MENU button (📖10) → Shooting menu → Image quality

Option	Description
<b>FINE</b> Fine	Finer image quality than <b>Normal</b> . Compression ratio of about 1:4
<b>NORM</b> Normal (default setting)	Normal image quality, suitable for most applications. Compression ratio of about 1:8

#### Image Quality Setting

- The setting for image quality is shown by an icon displayed on the monitor during shooting and playback (📖12 to 14).
- The image quality can be changed by selecting **Image quality** and rotating the command dial when menus are displayed.
- The setting is also applied to other shooting modes (except for shooting modes **U** and **Easy panorama** and **3D photography** in scene mode).
- Some features cannot be used in combination with other menu settings. See “Features Not Available in Combination” (📖75) for more information.

#### More Information









- See “Number of Exposures Remaining” (📖74) for more information.
- See “File and Folder Names” (📖90) for more information.

## Image Size

You can set the image size (amount of pixels) for pictures recorded.

The larger the image, the larger the size at which it can be printed or displayed without becoming noticeably “grainy,” limiting the number of pictures that can be recorded (📖74).

Display the shooting screen → MENU button (📖10) → Shooting menu → Image size

Option <sup>1</sup>	Aspect ratio (horizontal: vertical)	Print size <sup>2</sup> (cm/in.) (approx.)
 4896×3672 (default setting)	4:3	41 × 31/16 × 12
 3264×2448	4:3	28 × 21/11 × 8
 2272×1704	4:3	19 × 14/7.5 × 5.6
 1600×1200	4:3	13 × 10/5.3 × 4
 640×480	4:3	5 × 4/2 × 1.5
 4864×2736	16:9	41 × 23/16 × 9
 1920×1080	16:9	16 × 9/6 × 3.5
 4896×3264	3:2	41 × 28/16 × 11
 3672×3672	1:1	31 × 31/12 × 12

<sup>1</sup> The total number of pixels captured and the number of pixels captured horizontally and vertically.

Example:  **4896×3672** = Approx. 18 megapixels, 4896 × 3672 pixels

<sup>2</sup> The print size at an output resolution of 300 dpi.

Print sizes are calculated by dividing the number of pixels by the printer resolution (dpi) and multiplying by 2.54 cm (1 in.). However, even with the same image size setting, images printed at higher resolutions print smaller than the size indicated, and those printed at lower resolutions print larger than the size indicated.









### Image Size Setting

- The setting for the image size is shown by an icon displayed on the monitor during shooting and playback (📖12 to 14).
- The image size can be changed by selecting **Image size** and rotating the command dial when menus are displayed.
- The setting is also applied to other shooting modes (except for shooting modes **U** and **Easy panorama** and **3D photography** in scene mode).
- Some features cannot be used in combination with other menu settings. See “Features Not Available in Combination” (📖75) for more information.

### Number of Exposures Remaining

The following table lists the approximate number of images that can be saved on a 4 GB memory card. Note that due to JPEG compression, there is a significant difference in the number of images that can be actually saved depending on the composition of the image, even when the memory cards have the same capacity and the image quality and size settings are the same.

In addition, the number of images that can be saved may differ depending on the make of the memory card.

Image size	Image quality	Number of exposures remaining (4 GB)
 4896×3672	Fine	420
	Normal	740
 3264×2448	Fine	930
	Normal	1650
 2272×1704	Fine	1880
	Normal	3350
 1600×1200	Fine	3650
	Normal	6350
 640×480	Fine	20,100
	Normal	30,100
 4864×2736	Fine	560
	Normal	1000
 1920×1080	Fine	3440
	Normal	6030
 4896×3264	Fine	470
	Normal	840
 3672×3672	Fine	550
	Normal	990

- If the number of exposures remaining is 10,000 or more, “9999” is displayed.
- After removing the memory card, check the indicator showing the number of exposures that can be stored in the internal memory (approx. 15 MB) on the screen during shooting.

### Printing Images of Size 1:1

Change the printer setting to “Border” when printing images with the size set to 1:1.

The images may not be printed in 1:1 ratio depending on the printer.

See the instruction manual of the printer or check with the authorized print dealer for further details.

## Features Not Available in Combination

Some features cannot be used in combination with other menu settings.

Restricted function	Setting	Description
Flash mode	Focus mode (62)	When <b>▲</b> (infinity) is selected, the flash is not available.
	Continuous (68)	When <b>Continuous H</b> , <b>Continuous L</b> , <b>Pre-shooting cache</b> , <b>Continuous H: 120 fps</b> , <b>Continuous H: 60 fps</b> , <b>BSS</b> or <b>Multi-shot 16</b> is selected, the flash is not available.
	Exposure bracketing (69)	The flash is not available.
Self-timer/Smile timer	AF area mode (69)	When <b>Subject tracking</b> is selected, the self-timer/ smile timer are not available.
Focus mode	Smile timer (60)	When smile timer is selected, the focus mode is reset to <b>AF</b> (autofocus).
	AF area mode (69)	When <b>Subject tracking</b> is selected, <b>MF</b> (manual focus) is not available.
Image quality	Continuous (68)	When <b>Pre-shooting cache</b> or <b>Multi-shot 16</b> is selected, <b>Image quality</b> is fixed at <b>Normal</b> .
Image size	Continuous (68)	<ul style="list-style-type: none"> <li>When <b>Pre-shooting cache</b> is selected, <b>Image size</b> is fixed at <b>2M</b> (2048×1536 pixels).</li> <li>When <b>Continuous H: 120 fps</b> is selected, <b>Image size</b> is fixed at <b>10A</b> (640 × 480 pixels) and when <b>Continuous H: 60 fps</b> is selected, <b>Image size</b> is fixed at <b>2M</b> (1920 × 1080 pixels).</li> <li>When <b>Multi-shot 16</b> is selected, <b>Image size</b> is fixed at <b>5M</b> (2560 × 1920 pixels).</li> </ul>
ISO sensitivity	Continuous (68)	When <b>Pre-shooting cache</b> , <b>Continuous H: 120 fps</b> , <b>Continuous H: 60 fps</b> or <b>Multi-shot 16</b> is selected, <b>ISO sensitivity</b> is fixed at <b>Auto</b> .
	Active D-Lighting (69)	<ul style="list-style-type: none"> <li>When <b>ISO sensitivity</b> is set to <b>Auto</b> and <b>Active D-Lighting</b> is set to any mode other than <b>Off</b>, the maximum value for ISO sensitivity is set to ISO 800.</li> <li>When <b>Active D-Lighting</b> is set to any mode other than <b>Off</b>, <b>1600</b>, <b>3200</b> or <b>Hi 1</b> in <b>ISO sensitivity</b> is not available.</li> </ul>
White balance	Picture Control (68)	When <b>Monochrome</b> is selected for shooting, <b>White balance</b> is fixed at <b>Auto (normal)</b> .
Picture Control	Active D-Lighting (69)	When using <b>Active D-Lighting</b> , <b>Contrast</b> in manual adjustment cannot be adjusted.

## Features Not Available in Combination

Restricted function	Setting	Description
Metering	Active D-Lighting (📖69)	<b>Metering</b> is reset to <b>Matrix</b> when <b>Active D-Lighting</b> is set to any mode other than <b>Off</b> .
Continuous/ Exposure bracketing	Continuous (📖68)/Exposure bracketing (📖69)	Continuous and <b>Exposure bracketing</b> are not available simultaneously. <b>Exposure bracketing</b> is reset to <b>Off</b> when <b>Continuous</b> is set to any mode other than <b>Single</b> . The setting for <b>Continuous</b> is reset to <b>Single</b> when <b>Exposure bracketing</b> is set to any mode other than <b>Off</b> .
	Self-timer (📖59)	<b>Continuous H, Continuous L, Pre-shooting cache</b> or <b>BSS</b> and self-timer are not available simultaneously. When self-timer is set, a single picture is shot.
	Smile timer (📖60)	When the camera detects smiling faces and the shutter is released, only one picture is shot. When <b>Pre-shooting cache</b> is selected, the continuous shooting operates in <b>Single</b> mode. If interval timer shooting is set, shooting finishes automatically after one picture is shot.
	Picture Control (📖68)	<b>Exposure bracketing</b> cannot be used when <b>Monochrome</b> is selected.
AF area mode	Smile timer (📖60)	The camera takes a picture using face detection regardless of the applied <b>AF area mode</b> option.
	Focus mode (📖62)	<ul style="list-style-type: none"> <li>When a setting other than <b>Subject tracking</b> is selected and ▲ (infinity) is selected as the focus mode for shooting, the camera focuses at infinity regardless of the applied <b>AF area mode</b> option.</li> <li>When set to <b>MF</b> (manual focus), the AF area mode cannot be set.</li> </ul>
	Picture Control (📖68)	When <b>Target finding AF</b> is selected and <b>Picture Control</b> is set to <b>Monochrome</b> , the camera focuses on a face or selects the focus areas containing the subject closest to the camera out of 9 focus areas.
	White balance (📖68)	When <b>Target finding AF</b> is selected and <b>White balance</b> is set to <b>Preset manual, Incandescent, Fluorescent</b> or fine adjustment of white balance has been performed, the camera focuses on a face or selects the focus areas containing the subject closest to the camera out of 9 focus areas.

Restricted function	Setting	Description
Autofocus mode	Smile timer (📖60)	Autofocus mode option cannot be changed when smile timer is selected.
	Focus mode (📖62)	When the focus mode is set to ▲ (infinity), the autofocus mode operates using the <b>Single AF</b> setting.
	AF area mode (📖69)	When <b>Face priority</b> is selected for <b>AF area mode</b> , <b>Single AF</b> is automatically selected.
Active D-Lighting	ISO sensitivity (📖69)	When <b>ISO sensitivity</b> is set to <b>1600, 3200</b> or <b>Hi 1</b> , <b>Active D-Lighting</b> is not available.
Print date	Continuous (📖68)	When <b>Pre-shooting cache</b> , <b>Continuous H: 120 fps</b> or <b>Continuous H: 60 fps</b> is selected, print date is not available.
Sound settings	Continuous (📖68)	Shutter sound is disabled when <b>Continuous H</b> , <b>Continuous L</b> , <b>Pre-shooting cache</b> , <b>Continuous H: 120 fps</b> , <b>Continuous H: 60 fps</b> , <b>BSS</b> or <b>Multi-shot 16</b> is selected.
	Exposure bracketing (📖69)	Shutter sound is disabled.
Blink warning	Smile timer (📖60)/ Continuous (📖68)/Exposure bracketing (📖69)	Blink warning does not take effect when using the smile timer, <b>Continuous</b> is set to a setting other than <b>Single</b> or exposure bracketing is set.
Digital zoom	Smile timer (📖60)	The digital zoom cannot be used when smile timer is selected.
	Focus mode (📖62)	The digital zoom cannot be used when <b>MF</b> (manual focus) is selected.
	Continuous (📖68)	The digital zoom cannot be used when <b>Multi-shot 16</b> is selected.
	AF area mode (📖69)	The digital zoom cannot be used when <b>Subject tracking</b> is selected.
	Zoom memory (📖69)	The digital zoom cannot be used when <b>Zoom memory</b> is set to <b>On</b> .

### 👍 Notes on Digital Zoom

- The digital zoom cannot be used with certain shooting modes.
- When the digital zoom is in effect, selectable options for AF area mode or metering mode are restricted (📖71).

## The Control Range of the Shutter Speed (P, S, A, M Modes)

The control range of the shutter speed differs depending on the zoom position, aperture value or the ISO sensitivity setting. Additionally, the control range changes in the following continuous shooting settings.

Setting		Control range
ISO sensitivity (📖69) <sup>1</sup>	Auto <sup>2</sup> , Fixed range auto <sup>2</sup>	1/4000 <sup>3</sup> to 1 s ( <b>P, S, A</b> mode) 1/4000 <sup>3</sup> to 8 s ( <b>M</b> mode)
	ISO 80, 100	1/4000 <sup>3</sup> to 8 s
	ISO 200, 400	1/4000 <sup>3</sup> to 4 s
	ISO 800	1/4000 <sup>3</sup> to 2 s
	ISO 1600	1/4000 <sup>3</sup> to 1 s
	ISO 3200, Hi 1	1/4000 <sup>3</sup> to 1/2 s
Continuous (📖68)	Continuous H, Continuous L, BSS	1/4000 <sup>3</sup> to 1/30 s
	Pre-shooting cache, Multi-shot 16	1/4000 to 1/30 s
	Continuous H: 120 fps	1/4000 to 1/125 s
	Continuous H: 60 fps	1/4000 to 1/60 s
	Intvl timer shooting	1/4000 <sup>3</sup> to 1 s (up to 1/2 s when ISO sensitivity is set to ISO 3200 or Hi 1)

<sup>1</sup> The ISO sensitivity setting is restricted depending on the continuous shooting setting (📖75).

<sup>2</sup> In **M** mode, the ISO sensitivity is fixed at ISO 80.

<sup>3</sup> When the aperture value is set between f/6.6 and f/8.3 and the lens is at its maximum wide-angle zoom position, the maximum shutter speed will be 1/4000 second. The shutter speed becomes slower when the lens is at the telephoto zoom position and the aperture opening is bigger. When the aperture value is set to f/8.3 (largest aperture) and the lens is at its maximum telephoto zoom position, the maximum shutter speed will be 1/2500 second.



## Focusing on Subject

The focus area or focus range for adjusting focus varies depending on the shooting mode and focus mode (📖62).

- In **P, S, A, M, U** or special effects mode, focus area can be set by selecting **AF area mode** (📖69) in the shooting menu.

### Using the Target Finding AF

When **AF area mode** in **P, S, A, M** or **U** mode is set to **Target finding AF**, the camera will adjust the focus during the following operations if you press the shutter-release button halfway.

- When the camera detects the main subject, it focuses on that subject. When the subject is in focus, the focus areas that match up with the size of the subject will light in green (multiple areas may light up).

When detecting a human face, the camera focuses on it as a priority.

- The camera has 9 focus areas, and if it does not detect the main subject, it automatically selects the focus areas containing the subject closest to the camera. When the subject is in focus, the focus areas that are in focus light in green.

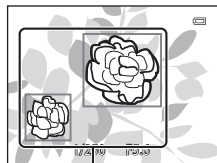

Focus area

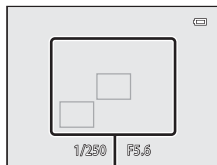

Focus area

### ✓ Notes on Target Finding AF

- Depending on shooting conditions, the subject that the camera determines to be the main subject may vary.
- The camera may not detect the main subject appropriately in the following situations:
  - When the subject is very dark or bright
  - When the main subject lacks clearly defined colors
  - When the shot is framed so that the main subject is on the edge of the monitor
  - When the main subject is composed of a repeating pattern
- In the following situations, the camera focuses on a face or selects the focus areas containing the subject closest to the camera out of 9 focus areas:
  - When **Picture Control** is set to **Monochrome**
  - When **White balance** is set to **Preset manual, Incandescent, Fluorescent**, or when fine adjustment of white balance has been performed

## Using Face Detection

In the following settings, the camera uses face detection to automatically focus on human faces. If the camera detects more than one face, a double border is displayed around the face that the camera will focus on, and single borders are displayed around the other faces.

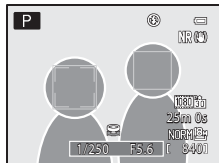

Setting	Number of faces that can be detected	Focus area (double border)
<b>Face priority</b> is selected for <b>AF area mode</b> (📖69) in <b>P, S, A, M</b> or <b>U</b> mode. <b>Scene auto selector, Portrait, Night portrait, Pet portrait*</b> scene modes (📖36)	Up to 12	The face closest to the camera
<input checked="" type="checkbox"/> (Smile timer) (📖60)	Up to 3	The face closest to the center of the frame

\* If **Pet portrait auto release** is switched to **OFF** when **Pet portrait** is selected, the camera will detect human faces (📖44).

- When using **Face priority**, if the shutter-release button is pressed halfway while no faces are detected or while framing a shot with no faces in it, the camera automatically selects the focus areas (up to 9) that contain the subject closest to the camera.
- When **Scene auto selector** is selected, the focus area changes depending on which scene the camera selects.
- When using **Portrait** or **Night portrait**, if no faces are detected when the shutter-release button is pressed halfway, the camera will focus on the subject at the center of the frame.
- When  (smile timer) is selected, if you press the shutter-release button halfway while no faces are detected, the camera will focus on the subject at the center of the frame.

### ✔ Notes on Face Detection

- The camera's ability to detect faces depends on a variety of factors, including whether or not the subject is facing the camera. Additionally, the camera may be unable to detect faces in the following situations:
  - When faces are partially hidden by sunglasses or otherwise obstructed
  - When faces take up too much or too little of the frame
- When the frame includes more than one face, the faces detected by the camera and the face on which the camera focuses depend upon a variety of factors, including the direction in which the subject is facing.
- In some rare cases, such as those described in "Autofocus" (📖81), the subject may not be in focus even though the double border turns green. If the camera does not focus, try "Focus Lock" (📖81).

### 📄 Viewing Pictures Taken Using Face Detection

- During playback, the camera automatically rotates images according to the orientation of the faces that were detected at the time of shooting (except for pictures taken using **Continuous** (📖68) or **Exposure bracketing** (📖69)).
- When zooming in on an image displayed in full-frame playback mode by rotating the zoom control toward **T** (📖), the image is enlarged at the center of the face that was detected during shooting (📖82).

## Focus Lock

Use focus lock to focus on off-center subjects when center is selected for AF area mode.

- Be sure that the distance between the camera and the subject does not change.
- When the shutter-release button is pressed halfway, the exposure is locked.

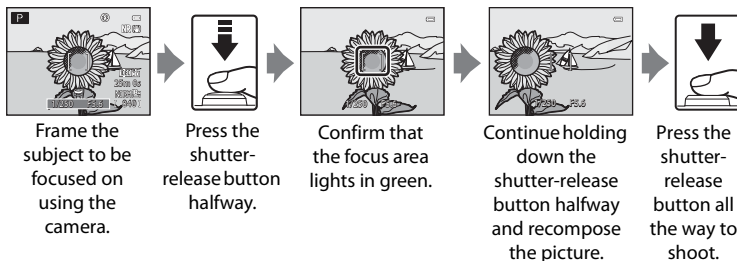

## Autofocus

Autofocus may not perform as expected in the following situations. In some rare cases, the subject may not be in focus despite the fact that the focus area or focus indicator lights in green.

- Subject is very dark
- Objects of sharply differing brightness are included in the scene (e.g., the sun behind the subject makes that subject appear very dark)
- No contrast between the subject and surroundings (e.g., a portrait subject, wearing a white shirt, is standing in front of a white wall)
- Several objects are at different distances from the camera (e.g., an animal inside a cage)
- Subjects with repeating patterns (window blinds, buildings with multiple rows of similarly shaped windows, etc.)
- Subject is moving rapidly

In these situations, try pressing the shutter-release button halfway to refocus several times, or focus on another subject and use focus lock. When using focus lock, be sure that the distance between the camera and the subject with which focus was locked is the same as that for the actual subject.

The camera can also focus using manual focus ( 62, 2).

# Playback Features

## Playback Zoom

Select an image to be enlarged in playback mode and rotate the zoom control toward **T** (Q).

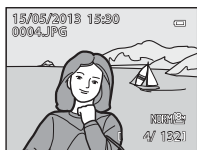
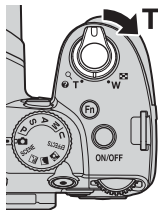

Image is displayed in full-frame playback mode.

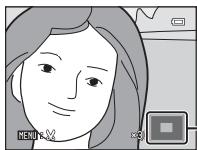

Image is zoomed in.

Display position guide

## Operations During Playback Zoom

Function	Operation	Description
Adjusting the magnification	<b>W</b> (Q) / <b>T</b> (Q)	<ul style="list-style-type: none"><li>The zoom increases up to 10x.</li><li>The zoom can also be adjusted by rotating the command dial.</li></ul>
Moving the display position		Move the display position.
Cropping	<b>MENU</b>	Crop only the displayed area of the image and save as a separate file (16).
Returning to full-frame playback mode	<b>OK</b>	Return to full-frame playback mode.

### Enlarging Images Recorded with Face Detection or Pet Detection



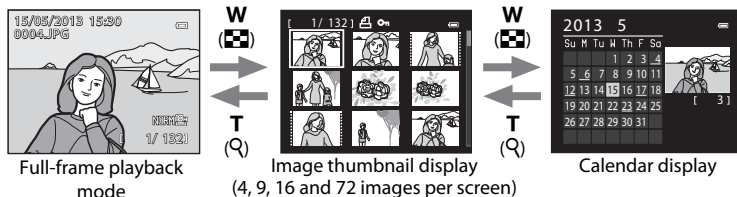
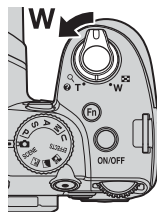

Pictures taken using face detection (80) or pet detection (44) are enlarged at the center of the face that was detected during shooting (excepting images recorded by **Continuous** (68) or **Exposure bracketing** (69)). If the camera detected multiple faces, use **▲**, **▼**, **◀**, and **▶** to display a different face. Change the zoom ratio and press **▲**, **▼**, **◀** or **▶** to zoom in on an area of the image where there are no faces.

## Viewing Several Images (Thumbnail Playback and Calendar Display)

Rotate the zoom control toward **W** (  ) in playback mode. This function will display several images at the same time, making it easy to find the desired image.



### Operations During Thumbnail Playback and Calendar Display

Function	Operation	Description
Changing the number of images displayed	<b>W</b> (  ) / <b>T</b> (  )	<ul style="list-style-type: none"> <li>Change the number of images to be displayed (4, 9, 16 and 72 images per screen).</li> <li>When 72 images are displayed, rotate the zoom control toward <b>W</b> (  ) to switch to calendar display.</li> <li>When calendar is displayed, rotate the zoom control toward <b>T</b> (  ) to switch to 72-image display.</li> </ul>
Selecting an image or date		<ul style="list-style-type: none"> <li>In thumbnail display mode, select an image.</li> <li>In calendar display mode, select a date.</li> </ul>
Returning to full-frame playback mode	<b>OK</b>	<ul style="list-style-type: none"> <li>In thumbnail display mode, the selected image is displayed in full-frame playback mode.</li> <li>In calendar display mode, the first image captured on the selected date is displayed in full-frame playback mode.</li> </ul>

#### Note on Calendar Display







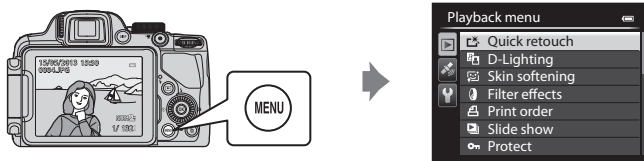











Pictures taken when the camera's date is not set are treated as images captured on "January 1, 2013."











## Features That Can Be Set Using the MENU (Menu) Button (Playback Mode)

When viewing images in full-frame playback mode or thumbnail playback mode, press the **MENU** button to set the playback menu (10).



### Available Playback Menus

Option	Description	
 Quick retouch <sup>1, 2, 3</sup>	Create retouched copies in which contrast and saturation have been enhanced.	 12
 D-Lighting <sup>1, 3</sup>	Create copies with enhanced brightness and contrast, brightening dark portions of an image.	 12
 Skin softening <sup>1, 2, 3</sup>	When this feature is enabled, the camera detects faces in pictures taken and creates a copy with softer facial skin tones.	 13
 Filter effects <sup>1, 3</sup>	Apply a variety of effects using digital filter. The available effects are <b>Soft, Selective color, Cross screen, Fisheye, Miniature effect, Painting and Vignette</b> .	 14
 Print order <sup>4, 5</sup>	When using a printer to print images saved on the memory card, the print order function can be used to select which images are printed, and how many copies of each image are printed.	 52
 Slide show	Images saved in the internal memory or on a memory card are played back in an automatic slide show.	 54
 Protect <sup>5</sup>	Protect selected images and movies from accidental deletion.	 55
 Rotate image <sup>3, 4, 5</sup>	Specify the orientation in which saved images are displayed in playback mode.	 55
 Small picture <sup>1, 3</sup>	Create a small copy of the picture taken. This feature is useful for creating copies for display on Web pages or e-mail attachments.	 15

Option	Description	
 Voice memo <sup>3</sup>	Use the camera's microphone to record voice memos and attach them to pictures taken. Playback and deletion of voice memos can also be performed.	 56
 Copy <sup>5</sup>	Copy images between the internal memory and a memory card. This function can also be used to copy movies.	 57
 Sequence display options	Display a sequence of images shot continuously as individual images, or display only the key picture of a sequence.	 58
 Choose key picture <sup>5</sup>	Change the key picture for the series of pictures that were shot continuously (pictures in a sequence,  8). <ul style="list-style-type: none"> <li>• When changing this setting, select the desired sequence before displaying the menu.</li> </ul>	 58

<sup>1</sup> This function is used to edit the currently selected image and save it as a separate file from the original file.

Note, however, that the following pictures cannot be edited.

- Pictures with 16:9, 3:2 or 1:1 aspect ratio
- Pictures taken using **Easy panorama** or **3D photography**

Note also that there is a restriction on retouching edited images ( 11).

<sup>2</sup> Pictures that were extracted from a movie cannot be edited using the quick retouch or skin softening function.

<sup>3</sup> This function cannot be used for pictures in the sequence when only the key picture is displayed. To use this function, press the  button to display individual images before displaying the menu.

<sup>4</sup> The function cannot be applied to pictures taken using **3D photography**.

<sup>5</sup> Select an image in the image selection screen. See "Using the Screen for Selecting Images" ( 86) for more information.

See "Editing Still Images" ( 10) and "The Playback Menu" ( 52) in the Reference Section for more information about each function.

## Using the Screen for Selecting Images

The image selection screen is displayed in the following menus.

Only one image can be selected for some menu items, while for other menu items, multiple images can be selected.

Functions for which only one image can be selected	Functions for which multiple images can be selected
<ul style="list-style-type: none"> <li>• <b>Playback menu:</b> Rotate image (👁55), Choose key picture (👁58)</li> <li>• <b>Setup menu:</b> <b>Select an image</b> in Welcome screen (👁64)</li> <li>• <b>PictBridge</b> (A printer is connected) : Print selection (👁20)</li> </ul>	<ul style="list-style-type: none"> <li>• <b>Playback menu:</b> <b>Select images</b> in Print order (👁52), Protect (👁55), <b>Selected images</b> in Copy (👁57)</li> <li>• <b>PictBridge</b> (A printer is connected) : <b>Print selection</b> in Print menu (👁21)</li> <li>• <b>Erase selected images</b> in Delete (📖33)</li> </ul>

Follow the procedure described below to select images.

### 1 Rotate the multi selector, or press ◀ or ▶ to choose the desired image.

- Rotate the zoom control toward **T** (📄) to switch to full-frame playback mode, or **W** (📖) to switch to 12-thumbnail display.
- For functions for which only one image can be selected, proceed to step 3.

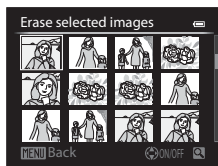

### 2 Press ▲ or ▼ to select ON or OFF (or the number of copies).

- When **ON** is selected, a check mark (☑) is displayed with the image. Repeat steps 1 and 2 to select additional images.



### 3 Press the Ⓞ button to apply the image selection.

- With selections such as **Erase selected images**, the confirmation dialog is displayed. Follow the instructions on the screen.



## Connecting the Camera to a TV, Computer, or Printer

You can enhance your enjoyment of images and movies by connecting the camera to a TV, computer, or printer.

- Before connecting the camera to an external device, make sure the remaining battery level is sufficient and turn the camera off. For information about the connection methods and subsequent operations, refer to the documentation included with the device in addition to this document.

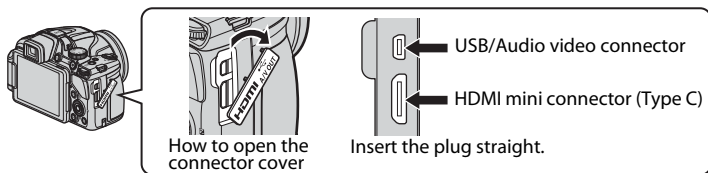

### Viewing images on a TV

 17



You can view the camera's images and movies on a TV.

Connection method: Connect the video and audio plugs of the included Audio Video Cable EG-CP16 to the TV's input jacks. Alternatively, connect a commercially available HDMI cable (Type C) to the TV's HDMI input jack.

### Viewing and organizing images on a computer

 88



If you transfer images to a computer, you can perform simple retouching and manage image data in addition to playing back images and movies.

Connection method: Connect the camera to the computer's USB input jack with the included USB cable.

- Before connecting to a computer, install ViewNX 2 on the computer using the included ViewNX 2 CD-ROM. See  90 for more information about using the included ViewNX 2 CD-ROM, and transferring images to a computer.
- If any USB devices that draw the power from the computer are connected, disconnect them from the computer before you connect the camera to it. Connecting the camera and other USB-powered devices to the same computer simultaneously may cause a camera malfunction or excessive power supply from the computer, which could damage the camera or memory card.

### Printing images without using a computer

 19



If you connect the camera to a PictBridge-compatible printer, you can print images without using a computer.

Connection method: Connect the camera directly to the printer's USB input jack with the included USB cable.

## Using ViewNX 2

ViewNX 2 is an all-in-one software package which enables you to transfer, view, edit and share images.

Install ViewNX 2 using the included ViewNX 2 CD-ROM.



### Installing ViewNX 2

- An Internet connection is required.

#### Compatible Operating Systems

##### Windows

Windows 8, Windows 7, Windows Vista, Windows XP

##### Macintosh

Mac OS X 10.6, 10.7, 10.8

Refer to the Nikon website for details on system requirements, including the latest information on operating system compatibility.

### 1 Start the computer and insert the ViewNX 2 CD-ROM into the CD-ROM drive.

- Windows: If instructions for operating the CD-ROM are displayed in the window, follow the instructions to proceed to the installation window.
- Mac OS: When the **ViewNX 2** window is displayed, double-click the **Welcome** icon.

## 2 Select a language in the language selection dialog to open the installation window.

- If the desired language is not available, click **Region Selection** to choose a different region and then choose the desired language (the **Region Selection** button is not available in the European release).
- Click **Next** to display the installation window.

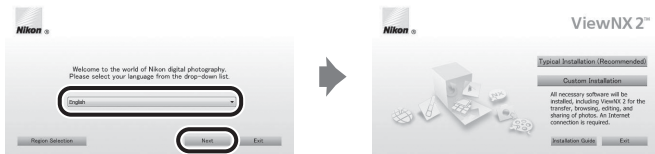

## 3 Start the installer.

- We recommend clicking **Installation Guide** in the installation window to check the installation help information and system requirements before installing **ViewNX 2**.
- Click **Typical Installation (Recommended)** in the installation window.

## 4 Download the software.

- When the **Software Download** screen is displayed, click **I agree - Begin download**.
- Follow the on-screen instructions to install the software.

## 5 Exit the installer when the installation completion screen is displayed.

- Windows: Click **Yes**.
- Mac OS: Click **OK**.

The following software is installed:

- ViewNX 2 (consisting of the three modules below)
  - Nikon Transfer 2: For transferring images to the computer
  - ViewNX 2: For viewing, editing, and printing transferred images
  - Nikon Movie Editor: For basic editing of transferred movies
- Panorama Maker (for creating a single panorama photo using a series of images shot in panorama assist scene mode)

## 6 Remove the ViewNX 2 CD-ROM from the CD-ROM drive.

## Transferring Images to the Computer

### 1 Choose how images will be copied to the computer.

Choose one of the following methods:

- **Direct USB connection:** Turn the camera off and ensure that the memory card is inserted in the camera. Connect the camera to the computer using the included USB cable. The camera automatically turns on. To transfer images that are saved in the camera's internal memory, remove the memory card from the camera before connecting it to the computer.

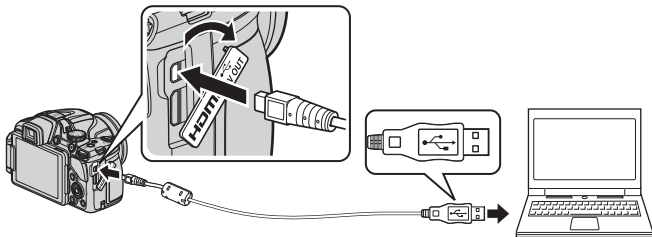

- **SD card slot:** If your computer is equipped with an SD card slot, the card can be inserted directly in the slot.
- **SD card reader:** Connect a card reader (available separately from third-party suppliers) to the computer and insert the memory card.

If a message is displayed prompting you to choose a program, select Nikon Transfer 2.

#### • When using Windows 7

If the dialog shown at right is displayed, follow the steps below to select Nikon Transfer 2.

- 1 Under **Import pictures and videos**, click **Change program**. A program selection dialog will be displayed; select **Import File using Nikon Transfer 2** and click **OK**.
- 2 Double-click **Import File**.

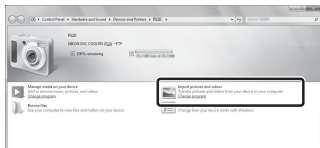

If the memory card contains a large number of images, it may take a while for Nikon Transfer 2 to start. Wait until Nikon Transfer 2 starts.

### ✓ Connecting the USB Cable

The connection may not be recognized if the camera is connected to the computer via a USB hub.

## 2 Transfer images to the computer.

- Confirm that the name of the connected camera or removable disk is displayed as the “Source” on the “Options” title bar of Nikon Transfer 2 (①).
- Click **Start Transfer** (②).

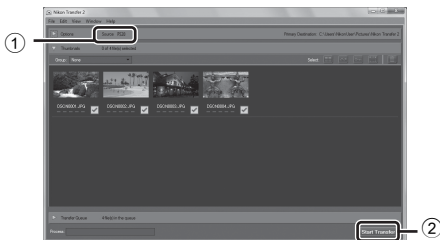

- At default settings, all the images on the memory card will be copied to the computer.

## 3 Terminate the connection.

- If the camera is connected to the computer, turn the camera off and disconnect the USB cable.
- If you are using a card reader or card slot, choose the appropriate option in the computer operating system to eject the removable disk corresponding to the memory card and then remove the card from the card reader or card slot.

## Viewing Images

### Start ViewNX 2.

- Images are displayed in ViewNX 2 when transfer is complete.
- Consult online help for more information on using ViewNX 2.



### Starting ViewNX 2 Manually

- **Windows:** Double-click the **ViewNX 2** shortcut on the desktop.
- **Mac OS:** Click the **ViewNX 2** icon in the Dock.

# Recording and Playing Back Movies

## Recording Movies

You can record movies by simply pressing the **●** (🎬 movie-record) button. Color tones, white balance, and other settings are the same as they are when taking still images.

- Only a short movie can be recorded in the internal memory. To record a movie, use a memory card (Class 6 or higher is recommended).

### 1 Turn on the camera and display the shooting screen.

- The movie options icon indicates the type of movie recorded (📖96).

\* The maximum movie length shown in the illustration differs from the actual value.

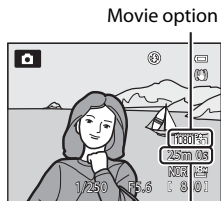

Maximum movie length\*

### 2 Press the **●** (🎬 movie-record) button to start movie recording.

- The camera focuses on the subject at the center of the frame. Focus areas are not displayed during recording.
- See "Focus and Exposure During Movie Recording" (📖 93) for more information.
- See "Pausing Movie Recording" (📖 93) for more information.

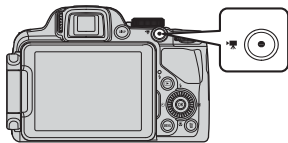





- When movies are recorded by setting **1080p 30p** for **Movie options** (i.e., pictures with 16:9 aspect ratio), the aspect ratio of shooting screen will switch to 16:9 (the movies are recorded in the area shown in the right side screen). Press the **DISP** (display) button and display the movie frame (📖9) to check the range of a movie in a frame before recording.







- The approximate remaining movie length is displayed on the monitor screen. When a memory card is not inserted, **L** is displayed and movie is saved to the internal memory.
- Recording stops automatically when the maximum movie length has been recorded.

### 3 Press the **●** (🎬 movie-record) button again to end recording.



## Focus and Exposure During Movie Recording

- The focus can be adjusted during movie recording in the following manner in accordance with the **Autofocus mode** (📖96) setting of the movie menu.
  - **AF-S Single AF** (default setting): The focus is locked when the  (movie-record) button is pressed to start movie recording. To adjust the focus using the autofocus again while recording movies, press the multi selector .
  - **AF-F Full-time AF**: The focus is adjusted repeatedly even during movie recording.
- When the focus mode (📖62) is **MF** (manual focus), adjust the focus manually. The focus can be adjusted during movie recording by rotating the multi selector clockwise to focus on near subjects or counterclockwise to focus on far subjects.
- Autofocus may not perform as expected (📖81). Should this occur, try **MF** (manual focus) (📖62, 🔄2) or set **Autofocus mode** in the movie menu to **AF-S Single AF** (default setting) and then use focus lock (📖81) to record.
- When the multi selector  is pressed during movie recording, the exposure is locked. To unlock, press  again.

## Pausing Movie Recording

When the  button is pressed during movie recording, recording is paused (except when using  **iFrame 540/30p**,  **iFrame 540/25p** or HS movies). To resume recording, press the  button again. If recording remains paused for more than 5 minutes or the  (movie-record) button is pressed, recording ends.

## Notes on Using Zoom During Movie Recording

- The zoom indicator is not displayed during movie recording.
- When the digital zoom is used, the image quality will deteriorate.
- If you start recording a movie without using digital zoom, and you keep rotating the zoom control toward **T** () , the zoom stops at the maximum optical zoom ratio. Remove your finger from the zoom control and then rotate it again toward **T** () to activate digital zoom. When movie recording ends, digital zoom is cancelled.

## ✔ Note on Recording Images and Saving Movies

The indicator showing the number of exposures remaining or the indicator showing the maximum movie length flashes while images are being recorded or while a movie is being saved. **Do not open the battery-chamber/memory card slot cover or remove the battery or memory card while an indicator is flashing.** Doing this could result in loss of data, or in damage to the camera or the memory card.

## ✔ Notes on Movie Recording

- When saving a movie onto a memory card, a memory card with an SD speed class of Class 6 or higher is recommended (📖21). If the transfer speed of the card is slow, the movie recording may end unexpectedly.
- The sounds of zoom control operation, zoom, autofocus, vibration reduction or aperture control when the brightness changes may be recorded.
- The following phenomena may be seen on the monitor screen while recording movies. These phenomena are saved in the recorded movies.
  - Banding may occur in images under fluorescent, mercury-vapor, or sodium-vapor lighting
  - Subjects that move quickly from one side of the frame to the other, such as a moving train or car, may appear skewed
  - The entire movie image may be skewed when the camera is panned
  - Lighting or other bright areas may leave residual images when the camera is moved

## ✔ Notes on the Camera Temperature

- The camera may become warm when recording movies for an extended period of time or when the camera is used in a hot area.
- When the temperature inside the camera becomes extremely high during movie recording, the camera may automatically stop recording to prevent internal damage to the camera. A 10-second countdown indicator (🕒10s) appears on the monitor, and then the camera automatically stops recording and turns off when the message **"The camera will turn off to prevent overheating."** is displayed.  
Leave the camera off until the inside of the camera has cooled and then use it.

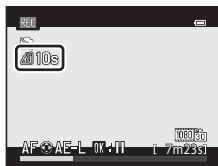

## 📎 Functions Available in Movie Recording

- The exposure compensation and **White balance** settings in shooting menu (📖67) are also applied with movie recording.
- When focus mode is set to 🍷 (macro close-up), the camera can zoom to a position closer to the subject to record movies. Confirm settings before starting movie recording.
- The self-timer (📖59) can be used. If the self-timer is set and the 📷 (movie-record) button is pressed, the camera starts movie recording after 10 or 2 seconds.
- The flash does not fire.
- Press the **MENU** button before starting to record the movie to display the 🎬 (movie) tab and select movie menu settings (📖96).



## Recording HS (High Speed) Movies



When **Movie options** (□96) of the movie menu is set to  $\overline{480}/\overline{120}$ / $\overline{480}/\overline{100}$  **HS 480/4x**,  $\overline{720}/\overline{60}$ / $\overline{720}/\overline{50}$  **HS 720/2x** or  $\overline{1080}/\overline{15}$ / $\overline{1080}/\overline{25}$  **HS 1080/0.5x**, movies that can be played back in slow motion or fast motion can be recorded.

## More Information

- See “Maximum Movie Length” (Ⓞ50) for more information.
- See “File and Folder Names” (Ⓞ90) for more information.

## Saving Still Pictures While Recording Movies

If the shutter-release button is pressed all the way while recording a movie, one frame is saved as a still picture. Movie recording continues while the still picture is being saved.

- The maximum number of still pictures that can be saved during a movie recording (10 pictures) and  are displayed at the top left of the monitor. When  is displayed, a still picture cannot be saved.
- The image size of the still pictures to be saved is set to  $\overline{1920}/\overline{1080}$  (1920 × 1080).



## Notes on Saving Still Pictures During Movie Recording

- Still pictures cannot be saved during movie recording in the following situations.
  - When movie recording is paused
  - When a movie is recorded in the internal memory
  - When the remaining movie length is less than 10 seconds
  - When **Movie options** (□96) is set to  $\overline{1080}/\overline{60}$  **1080/60i**,  $\overline{1080}/\overline{50}$  **1080/50i**,  $\overline{480}/\overline{30}$  **480/30p**,  $\overline{480}/\overline{25}$  **480/25p** or HS movie
- Frames of a movie that were recorded when a still picture was being taken may not be played back in a seamless manner.
- The sounds of operating the shutter-release button when saving a still picture may be heard in the recorded movie.
- If the camera moves when the shutter-release button is pressed, the picture may be blurred.



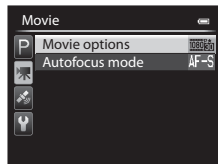

## Features That Can Be Set Using the MENU (Menu) Button (Movie Menu)

Display the shooting screen → MENU button →  tab (10)

Press the **MENU** button on the shooting screen to display the menu screen and select the  tab to change the following settings on the movie menu.



### Available Movie Menus

Option	Description	
Movie options	Select the type of movie to be recorded. The camera can record normal speed movies and HS (high speed) movies, which can be played back in slow motion or fast motion. The default setting is  <b>1080★/30p</b> or  <b>1080★/25p</b> .	 48
Autofocus mode	Select how the camera focuses when recording normal speed movies. <b>Single AF</b> (default setting) where the focus is locked when movie recording begins, or <b>Full-time AF</b> where the camera focuses continuously during movie recording can be selected. When <b>Full-time AF</b> is selected, the sound of the camera focusing may be heard in recorded movies. If you want to prevent the sound of the camera focusing from being recorded, select <b>Single AF</b> .	 51

#### **More Information**

See "Basic Menu Operations" (10) for more information.

# Playing Back Movies

**1** Press the  (playback) button to select playback mode.

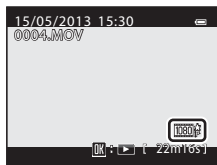

- Use the multi selector to select a movie.
- Movies can be recognized by the movie options icon (50).











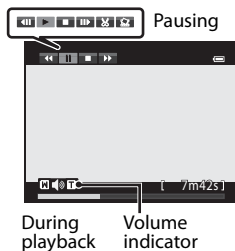







**2** Press the  button to play back a movie.





## Operations Available During Movie Playback

Rotate the multi selector to fast forward or rewind. Playback controls appear at the top of the monitor.

Press the multi selector  or  to select an icon of playback control, then press the  button to perform the following operations.



To	Use	Description
Rewind		Rewind the movie while the  button is pressed down.
Advance		Advance the movie while the  button is pressed down.
Pause		The following operations can be performed with the playback controls at the top of the monitor while playback is paused.
		 Rewind the movie by one frame. Hold down the  button to rewind continuously.*
		 Advance the movie by one frame. Hold down the  button to advance continuously.*
		 Extract and save only the required parts of the movie (  24).
		 Save the extracted frame from a movie as a still picture (  25).
		Resume playback.
End		Return to full-frame playback mode.

\* The movie can also be advanced or rewound by one frame by rotating the multi selector. To delete a movie, use full-frame playback mode (32) or thumbnail playback mode (83) to select a movie and press the  button (33).

## Adjusting the Volume

Operate the zoom control **T/W** (1) during playback.

# Using GPS

## Starting GPS Data Recording

The camera's internal GPS receives signals from the GPS satellites and identifies its current time and position.

The position information (latitude and longitude) can be recorded on the pictures to be shot.

### Turn the GPS Functions On

Press the **MENU** button →  (GPS options) tab (📖11) → GPS options

Set **Time zone and date** (📖103) correctly before using the GPS function.

- 1 Use the multi selector to select **Record GPS data**, and then press the **OK** button.

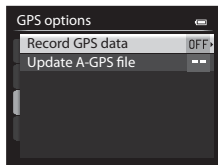

- 2 Select **On** and press the **OK** button.

- Signals are received from the GPS satellites and positioning starts.
- The default setting is **off**.

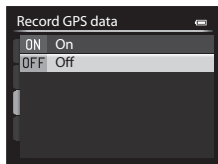

- 3 Press the **MENU** button.

- The camera returns to shooting screen.
- Operate in an open-air area when starting to receive signals from GPS satellites.





## ✓ Notes on GPS

- Before using the GPS functions, read “<Important> Notes on GPS” (📖xi).
- It takes a few minutes to obtain position information when positioning is performed for the first time or in a situation where positioning cannot be performed for a long period of time, or just after the battery is replaced.
- Positions of the GPS satellites change constantly.  
You may not be able to determine the position or it may take some time depending on your location and the time.  
To use the GPS feature, use the camera in an open-air area with few obstacles in the sky.  
Signal receiving will be smoother if the GPS antenna (📖2) is facing the sky.
- The following locations which block or reflect signals may result in failed or inaccurate positioning.
  - Inside buildings or underground locations
  - Between high-rise buildings
  - Under overpasses
  - Inside tunnels
  - Near high-voltage electrical power lines
  - Between clusters of trees
- Using a mobile phone of 1.5 GHz band near this camera may disrupt positioning.
- When carrying this camera around while positioning, do not place it in a metal bag.  
Positioning cannot be performed if the camera is covered with metal materials.
- When there is a significant difference in the signals from the GPS satellites, there could be a deviation of up to several hundred meters.
- Be aware of your surroundings when positioning.
- The shooting date and time that is displayed when playing back images is determined by the camera’s internal clock at the time of shooting.  
The time obtained by the position information and recorded on images will not be displayed on the camera.
- Position information for the first frame will be recorded on a series of pictures shot using continuous shooting.

## ✓ Battery Drain While Recording GPS Data



- When **Record GPS data** is set to **On**, GPS functions will continue to operate at the specified interval for approximately 6 hours even after the camera is turned off. Also, GPS functions will continue to operate while recording log data (📖102) even after the camera is turned off.
- When **Record GPS data** is set to **On**, battery power drains faster than usual. Confirm the battery level especially when the camera is recording log data.

## GPS Reception Indicator and Point of Interest (POI) Information

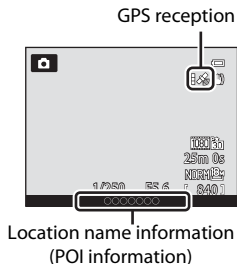
- GPS reception can be checked on the shooting screen.
  - : Signals are being received from four or more satellites and positioning is being performed. Position information is recorded on the image.
  - : Signals are being received from three satellites and positioning is being performed. Position information is recorded on the image.
  - : Signals are no longer received from the satellites. If the camera has position information that has been obtained in the last 1 minute, this position information is recorded on the image.
  - : Signals cannot be received from the satellites, and positioning is not possible. The position information is not recorded on the image.
- POI information is location name information for the nearest landmarks (facilities) and other details.
  - When **Display POI** in **Points of interest (POI)** of the GPS options menu ( 101) is set to **On**, the nearest location name information for the current location is displayed during shooting.
  - When **Embed POI** is set to **On**, location name information can be recorded on the image during shooting.
  - When images recorded with the location name information are played back, the location name information that was recorded during shooting will be displayed if **Display POI** is set to **On**.
- “----” may be displayed for the location name information depending on the setting level in **Level of detail** of **Points of interest (POI)**. Also, certain landmark names may not be registered, or the landmark name may be different.



## Pictures with Recorded Position Information

- The  icon is displayed during playback for images which have the position information recorded ( 14).
- Position information recorded on a picture can be checked on a map with ViewNX 2 after transferring the image to a computer ( 88).
- The actual place of shooting may differ from the GPS information recorded on the image files due to the accuracy of the position information obtained and a difference in the geodetic system used.



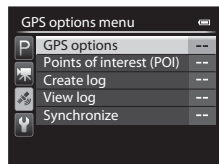

## Features That Can Be Set Using the MENU (Menu) Button (GPS Options Menu)

Press the MENU button →  (GPS options) tab ( 11)





When the  tab is selected on the menu screen, the following option settings can be changed in the GPS options menu.



### Options Available in the GPS Options Menu

Option	Description	
GPS options	<p><b>Record GPS data:</b> When set to <b>On</b>, signals are being received from the GPS satellites and positioning starts ( 98). The default setting is <b>Off</b>.</p> <p><b>Update A-GPS file:</b> A memory card is used to update the A-GPS (assist GPS) file. Using the latest A-GPS file can shorten the time needed for tracking the position information.</p> <ul style="list-style-type: none"> <li>Download the latest A-GPS file from the website below, and use it to update the file. <a href="http://nikonimglib.com/agps2/index.html">http://nikonimglib.com/agps2/index.html</a></li> </ul>	 59
Points of interest (POI)	<p>Make the settings for the POI (points of interest, location name information).</p> <p><b>Embed POI:</b> When set to <b>On</b>, the location name information is recorded on the pictures to be shot. The default setting is <b>Off</b>.</p> <p><b>Display POI:</b> When set to <b>On</b>, the location name information is displayed on the shooting and playback screens. The default setting is <b>Off</b>.</p> <p><b>Level of detail:</b> Set the display level of the location name information. A higher display level shows more detailed regional information, and a lower display level shows regional information for a wider area (such as country names).</p> <p><b>Edit POI:</b> The level of the location name information recorded on the image can be changed, and the regional information can be deleted.</p>	 60



## Features That Can Be Set Using the MENU (Menu) Button (GPS Options Menu)

Option	Description	
Create log	<p>The measured position information is recorded at the interval set for <b>Log interval</b> until a preset time set using <b>Start log</b> is reached (only when <b>Record GPS data</b> in <b>GPS options</b> of the GPS options menu is set to <b>On</b>).</p> <ul style="list-style-type: none"> <li>• Select <b>End log</b> and save the recorded log data to a memory card.</li> </ul>	 61
View log	<p>You can check or erase the log data stored on a memory card by selecting <b>Create log</b> and then selecting <b>End log</b>.</p> <ul style="list-style-type: none"> <li>• To erase log data, select a log data and press the  button.</li> </ul>	 63
Synchronize	<p>Signals from the GPS satellites are used to set the date and time of the camera's internal clock (only when <b>Record GPS data</b> in <b>GPS options</b> of the GPS options menu is set to <b>On</b>).</p>	 63









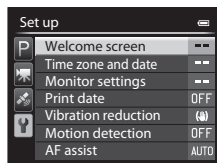

# General Camera Setup

## The Setup Menu















Press the MENU button →  (setup) tab ()







From the menu screen, select the  tab to display the setup menu, and then you can change the following settings.









Option	Description	
Welcome screen	Set whether or not the welcome screen is displayed when power is turned on. The welcome screen image can be selected. The default setting is <b>None</b> .	 64
Time zone and date	Set settings related to the camera's date and time. The <b>Time zone</b> setting allows you to specify the time zone where the camera is mainly used and whether or not daylight saving time is in effect. When the  travel destination is set, the camera automatically calculates the time difference between the travel destination and the  home time zone, and saves images using the date and time of the travel destination.	 65
Monitor settings	Set the image display after shooting, the screen brightness, and whether or not to display a framing grid or histograms on the monitor.	 67
Print date	Imprint the shooting date and time on pictures at the time of shooting. The default setting is <b>Off</b> . Dates cannot be imprinted in the following situations. - When the scene mode is set to <b>Easy panorama</b> , <b>Panorama assist</b> or <b>3D photography</b> - When <b>Pre-shooting cache</b> , <b>Continuous H: 120 fps</b> or <b>Continuous H: 60 fps</b> is selected for <b>Continuous</b> (  ) - During movie recording	 68

## The Setup Menu

Option	Description	
Vibration reduction	<p>Reduce blurring caused by camera shake when shooting. The default setting is <b>Normal</b>.</p> <ul style="list-style-type: none"> <li>• If a comparatively large camera shake is likely to occur when shooting from a car or under poor foothold conditions, set <b>Vibration reduction</b> to <b>Active</b>.</li> <li>• When using a tripod to stabilize the camera, set this feature to <b>Off</b> to prevent this feature from malfunctioning.</li> <li>• If this feature is assigned to the <b>Fn</b> (function) button using <b>Fn button</b>, its setting menu can be also displayed on the screen by pressing the <b>Fn</b> (function) button during shooting (71).</li> </ul>	 69
Motion detection	<p>When the camera detects camera shake or subject movement at the time of shooting, it automatically increases ISO sensitivity and shutter speed to reduce blurring. The default setting is <b>Off</b>.</p> <p>The  indicator lights in green when the camera detects camera shake or subject movement and increases shutter speed.</p> <ul style="list-style-type: none"> <li>• When using certain shooting modes or settings, motion is not detected. In this case the  indicator is not displayed.</li> </ul>	 70
AF assist	<p>When set to <b>Auto</b> (default setting), the AF-assist illuminator (30) lights if shooting in dark surroundings to help the camera focus.</p> <ul style="list-style-type: none"> <li>• Even if <b>Auto</b> is selected, the AF-assist illuminator may not light depending on the position of the focus area or the scene mode that is selected.</li> </ul>	 71
Digital zoom	<p>When set to <b>On</b> (default setting), rotating and holding the zoom control toward <b>T</b> () triggers the digital zoom (29) if the optical zoom is at the maximum telephoto zoom position.</p> <ul style="list-style-type: none"> <li>• The digital zoom cannot be used simultaneously in certain settings such as shooting mode.</li> </ul>	 71
Assign side zoom control	<p>Select the function to be performed during shooting when the side zoom control is rotated. When set to <b>Zoom</b> (default setting), the zoom control operation is enabled.</p>	 72
Sound settings	<p>Turn various camera sounds on and off. In the default setting, beep sounds are on.</p> <ul style="list-style-type: none"> <li>• The operation sound is disabled in certain settings such as shooting mode.</li> </ul>	 73
Auto off	<p>Set the amount of time that passes before the monitor is turned off to save power. The default setting is <b>1 min</b>.</p>	 73

Option	Description	
Format memory/ Format card	Format the internal memory (only when a memory card is not inserted) or the memory card (when a memory card is inserted). <ul style="list-style-type: none"> <li>• <b>All data stored in the internal memory or on the memory card is deleted during formatting and cannot be restored.</b> Be sure to transfer important images to a computer and save them before formatting.</li> </ul>	 74
Language	Change the camera's display language.	 74
TV settings	Adjust settings for connection to television. <ul style="list-style-type: none"> <li>• When the camera is connected to a television using an audio/video cable but no picture is displayed on the television, set <b>Video mode</b> to <b>NTSC</b> or <b>PAL</b> according to the type of signal compatible with the television.</li> <li>• HDMI settings can be set.</li> </ul>	 75
Charge by computer	When set to <b>Auto</b> (default setting), you can charge the camera's battery by connecting the camera to a computer (provided that the computer is able to supply power). <ul style="list-style-type: none"> <li>• When charging by computer, it may take more time to charge the battery than when using the Charging AC Adapter EH-69P.</li> </ul>	 76
Toggle Av/Tv selection	Switch the method for setting the flexible program, shutter speed or aperture value. When <b>Do not toggle selection</b> (default setting) is selected, use the command dial to set the flexible program or shutter speed and use the multi selector to set the aperture value. When <b>Toggle selection</b> is selected, use the multi selector to set the flexible program or shutter speed and use the command dial to set the aperture value. <ul style="list-style-type: none"> <li>• This option is enabled only when the shooting mode is <b>P</b>, <b>S</b>, <b>A</b>, <b>M</b> or <b>U</b>.</li> </ul>	 78
Reset file numbering	When <b>Yes</b> is selected, the sequential numbering of file numbers is reset. After resetting, a new folder is created and the file number for the next image taken starts from "0001."	 78

## The Setup Menu

Option	Description	
Blink warning	When the camera detects that a human subject may have closed the eyes immediately after taking a picture using face detection while shooting with modes other than the smile timer (  80), the <b>Did someone blink?</b> screen is displayed on the monitor to check the picture taken. The default setting is <b>Off</b> .	 79
Eye-Fi upload	Set whether or not to enable the function for sending images to a computer using a commercially available Eye-Fi card. The default setting is <b>Enable</b> (when an Eye-Fi card is in the camera).	 80
Reverse indicators	Set the +/- display direction of exposure indicator to be displayed when the shooting mode is <b>M</b> .	 80
Reset all	Reset the camera's settings to their default values. <ul style="list-style-type: none"> <li>• Some of the settings such as <b>Time zone and date</b> and <b>Language</b> and user settings that were saved for mode dial <b>U</b> are not reset.</li> </ul>	 81
Firmware version	Display the current camera firmware version.	 84



# Reference Section

The Reference Section provides detailed information and hints for using the camera.

## Shooting

---

Taking Pictures With Manual Focus.....		02
Using Easy Panorama (Shooting and Playing back) .....		03
Using Panorama Assist .....		06

## Playback

---

Playing Images in a Sequence .....		08
Editing Still Images .....		10
Connecting the Camera to a TV (Viewing Images on a TV).....		17
Connecting the Camera to a Printer (Direct Print) .....		19

## Movies

---

Editing Movies .....		24
----------------------	--	----

## Menu

---

Shooting Menu ( <b>P</b> , <b>S</b> , <b>A</b> or <b>M</b> Mode).....		26
Movie Menu.....		48
The Playback Menu.....		52
GPS Options Menu .....		59
The Setup Menu.....		64

## Additional Information

---

Error Messages .....		85
File and Folder Names .....		90
Optional Accessories.....		92

# Taking Pictures With Manual Focus

Available when the shooting mode is **P**, **S**, **A**, **M**, **U**, special effects mode or **Sports** scene mode.

## 1 Press the multi selector ▼ (MF focus mode).

- Use the multi selector to choose **MF** (manual focus) and press the **OK** button.
- **MF** is displayed on the top of the monitor, and the center of the picture is enlarged.

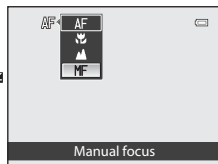
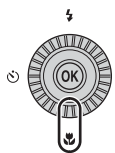

## 2 Adjust the focus.

- Use the multi selector to adjust the focus while viewing the image on the monitor screen.
- Rotate the multi selector to adjust the focus.
  - Rotate counterclockwise: focus on far subjects
  - Rotate clockwise: focus on near subjects
- The focus can be adjusted in higher detail by rotating the multi selector slowly.
- When **▶** is pressed, first the camera is focused with autofocus, and then the manual focus can be operated. Choose **Yes** and press the **OK** button to focus on the subject at the center of the frame with autofocus.
- Press the shutter-release button halfway to check the composition. Press the shutter-release button all the way to take the picture.

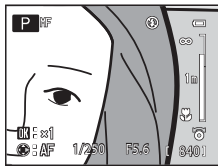

## 3 Press the **OK** button.

- The set focus is locked.
- Press the shutter-release button all the way to take the picture.
- To readjust the focus, press the **OK** button again to display the screen in step 2.
- To change back to autofocus, return to step 1 and choose any setting other than **MF**.

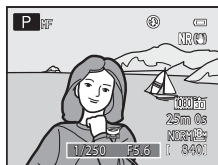

## MF (Manual Focus)

- The digits displayed for the gauge on the right of the monitor in step 2 serve as a guideline for the distance (m) to a subject that is in focus when the gauge indicates the center. The actual range at which the subject can be in focus varies depending on the aperture value and zoom position. To see whether the subject is in focus, check the subject on the monitor.
- Press the shutter-release button halfway to preview an approximate depth of field (the area in focus behind and in front of the subject).
- Set **Assign side zoom control** (72) in the setup menu to **Manual focus** to focus by using the side zoom control instead of the multi selector in step 2.
- The digital zoom is not available.



# Using Easy Panorama (Shooting and Playing back)

## Taking Pictures with Easy Panorama

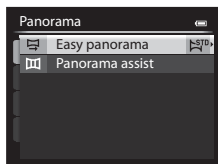

Rotate the mode dial to SCENE → MENU button →  Panorama

- 1 Select  **Easy panorama** and press the  button.



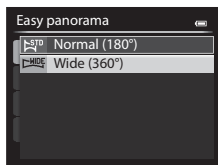

- 2 Select the shooting range from  **Normal (180°)** or  **Wide (360°)**, and press the  button.



- The image sizes (W × H) when the camera is held in landscape orientation are as follows.
  -  **Normal (180°)**:  
4800 × 920 when the camera is moved horizontally,  
1536 × 4800 when the camera is moved vertically
  -  **Wide (360°)**:  
9600 × 920 when the camera is moved horizontally,  
1536 × 9600 when the camera is moved vertically
- For the image sizes when the camera is held in "tall" orientation, the combinations of the moving direction and W × H are the opposites of the above.
- Pictures taken in this mode are saved with **Normal** as the image quality.

- 3 Frame the first portion of the panorama scene, and press the shutter-release button halfway to adjust the focus.

- The zoom is fixed at the wide-angle position.
- The framing guide is displayed on the monitor.
- The camera focuses on the subject at the center of the frame.
- Exposure compensation (64) can be adjusted.
- If the focus or exposure cannot be set for the main subject, try the focus lock (81).

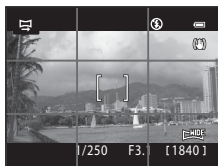

#### 4 Press the shutter-release button all the way, and release it.

- The  icons showing the panorama direction are displayed.





#### 5 Move the camera straight and slowly in one of the four directions to start shooting.

- When the camera detects the panorama direction, the shooting starts.
- The guide showing the current shooting point is displayed.
- When the guide showing the shooting point reaches the end, the shooting ends.



Guide

#### Example of Moving the Camera

- The user, without shifting position, moves the camera, from end to end of the guide, horizontally or vertically in an arc.
- If about 15 seconds (in  **Normal (180°)**) or 30 seconds (in  **Wide (360°)**) pass from the start of the shooting, and before the guide showing the shooting point reaches the end, the shooting ends.



#### Notes on Easy Panorama Shooting

- The image area seen in the saved image will be narrower than that seen on the monitor at the time of shooting.
- When the camera movement speed is too fast, there is a large amount of camera shake or there is little change in subject such as wall or in the dark, the shooting ends in an error.
- Panorama pictures are not saved when the shooting stops before reaching half of the panorama range.
- When the shooting reaches more than half of the panorama range but finishes before the end point, the range that is not shot will be recorded as a gray area.



## Viewing Easy Panorama (Scroll)

Switch to playback mode (📖32), display the picture recorded with Easy panorama in full-frame playback mode and press the **OK** button. The camera displays the short side of the picture filling the entire screen and scrolls the displayed area automatically.

- **STD** or **WIDE** is displayed for pictures recorded with Easy panorama.
- The picture is scrolled in the direction of the panorama shooting.
- Rotate the multi selector to advance or rewind.

Playback controls are displayed at the top of the monitor during playback. When you choose a playback control with the multi selector ◀ or ▶ and press the **OK** button, the following operations can be performed.

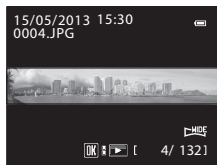

To	Use	Description	
Rewind	◀◀	Scroll quickly back while the <b>OK</b> button is pressed.*	
Advance	▶▶	Scroll quickly forward while the <b>OK</b> button is pressed.*	
Pause		The following operations can be performed with the playback controls at the top of the monitor while playback is paused.	
		◀	Rewind while the <b>OK</b> button is pressed.*
		▶	Scroll while the <b>OK</b> button is pressed.*
End	■	Restart the automatic scroll.	
	■	Return to full-frame playback mode.	

\* These operations can also be performed by rotating the multi selector.

### ✔ Note on Viewing Pictures Recorded with Easy Panorama

Panorama pictures recorded with functions other than Easy panorama of the COOLPIX P520 may not be scrolled or zoomed on this camera.

# Using Panorama Assist

Using a tripod makes the composition easier. When using a tripod to stabilize the camera, set **Vibration reduction** (669) to **Off** in the setup menu.





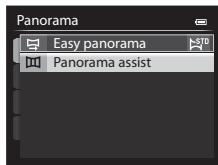

Rotate the mode dial to **SCENE** → **MENU** button →  Panorama

## 1 Select **Panorama assist** and press the **OK** button.

- The  icon is displayed to show the direction in which pictures are joined.



## 2 Use the multi selector to choose the direction, and press the **OK** button.

- Select the direction in which pictures are joined in the completed panorama: right () , left () , up () or down () .
- The yellow icon () moves to the selected direction, so press the **OK** button to select the direction. A white icon () is displayed in the selected direction.
- Apply flash mode (656), self-timer (659), focus mode (662) and exposure compensation (664) settings with this step, if necessary.
- Press the **OK** button again to reselect the direction.

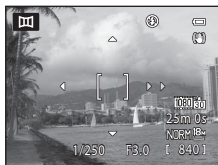

## 3 Frame the first portion of the panorama scene, and take the first picture.

- The camera focuses on the subject at the center of the frame.
- 1/3 of the image will be displayed as translucent.

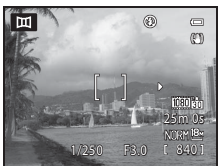

## 4 Shoot the next picture.

- Match the outline of the next picture so that 1/3 of the frame overlaps the previous picture, and press the shutter-release button.
- Repeat until you have taken the necessary number of pictures to complete the image.



## 5 Press the **OK** button when shooting is completed.

- The camera returns to step 2.

### **Notes on Panorama Assist**

- Set the flash mode, self-timer, focus mode and exposure compensation before releasing the shutter for the first picture. The settings cannot be changed after shooting the first picture. Pictures cannot be deleted, nor can zoom, **Image quality** (📖72) or **Image size** (📖73) be adjusted after shooting the first picture.
- The panorama series is terminated if the auto off function (🔌73) triggers the standby mode during shooting. To prevent this, setting a longer time for the auto off function is recommended.

### **AE/AF-L (Exposure Lock) Indicator**

When using panorama assist mode, all pictures in the panorama have the same exposure, white balance, and focus as the first picture of the panorama.

When the first picture is shot, **AE/AF-L** is displayed on the monitor to indicate that exposure, white balance, and focus are locked.

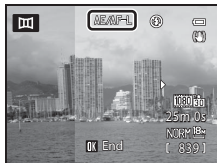

### **Panorama Creation with Panorama Maker**

Transfer pictures to a computer (📖90) and use Panorama Maker to join them in a single panorama.

- Panorama Maker can be installed on a computer using the included ViewNX 2 CD-ROM (📖88).
- For more information on using Panorama Maker, refer to the on-screen instructions and help information contained in Panorama Maker.

### **More Information**

See "File and Folder Names" (🔌90) for more information.

## Playing Images in a Sequence

The images shot in the following continuous shooting mode are saved as a group (called a “sequence”) each time you shoot.

- **Continuous H, Continuous L, Pre-shooting cache, Continuous H: 120 fps** or **Continuous H: 60 fps** in **Continuous** (📷34) in the shooting menu
- **Sports** (📖40) or **Continuous** in the **Pet portrait** (📖44) scene mode

In full-frame playback mode or thumbnail playback mode (📖83), the first image of a sequence is used as the “key picture,” i.e., it is displayed to represent the images in the sequence.

Sequence display



While the key picture of a sequence is displayed in full-frame playback mode, press the **OK** button to display each image in the sequence individually. To return to key picture only display, press the multi selector **▲**.

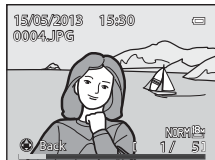

The following operations can be performed when each image in a sequence is displayed individually.

- Select an image: Rotate the multi selector or press **◀** or **▶**.
- Zoom in: Rotate the zoom control toward **T** (📷) (📖82).

### ✔ Note on Sequence

Pictures captured continuously with cameras other than the COOLPIX P520 cannot be displayed as a sequence.

### 📎 Sequence Display Options

Select **Sequence display options** (📷58) in the playback menu to set all sequences to be displayed using their key pictures or to display them as individual images.

If an image in the sequence is selected when **Sequence display options** is set to **Individual pictures**, 📷 icon is displayed on the monitor.

### 📎 Changing Key Picture in Sequence

A sequence's key picture can be changed using **Choose key picture** (📷58) in the playback menu.

## Deleting Images in a Sequence

When **Sequence display options** (👁️58) is set to **Key picture only** in the playback menu, if the 🗑️ button is pressed and the deletion method is selected, the following images are deleted.

- When a sequence is displayed by its key picture only:
  - **Current image:** When the sequence is selected, all images in the sequence are deleted.
  - **Erase selected images:** When the key picture is selected in the erase selected images screen (📖34), all images in the sequence are deleted.
  - **All images:** All images including the sequence that is displayed are deleted.
- If the key picture is selected and the OK button is pressed to display individual images in the sequence before pressing the 🗑️ button:
 

The deletion methods change to the followings.

  - **Current image:** Delete the image that is displayed.
  - **Erase selected images:** Select multiple images in the sequence to delete in the erase selected images screen (📖34).
  - **Entire sequence:** All images in the sequence, including the image that is displayed, are deleted.

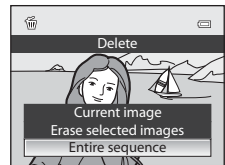

## Playback Menu Options Available When Using Sequence

When the **MENU** button is pressed during an image sequence playback, the following menu operations are available.

- |                               |        |                              |        |
|-------------------------------|--------|------------------------------|--------|
| • Quick retouch <sup>1</sup>  | → 👁️12 | • Rotate image <sup>1</sup>  | → 👁️55 |
| • D-Lighting <sup>1</sup>     | → 👁️12 | • Small picture <sup>1</sup> | → 👁️15 |
| • Skin softening <sup>1</sup> | → 👁️13 | • Voice memo <sup>1</sup>    | → 👁️56 |
| • Filter effects <sup>1</sup> | → 👁️14 | • Copy <sup>2</sup>          | → 👁️57 |
| • Print order <sup>2</sup>    | → 👁️52 | • Sequence display options   | → 👁️58 |
| • Slide show                  | → 👁️54 | • Choose key picture         | → 👁️58 |
| • Protect <sup>2</sup>        | → 👁️55 |                              |        |

<sup>1</sup> Press the **MENU** button after displaying individual images. Settings can be applied to individual images.

<sup>2</sup> When the **MENU** button is pressed during displaying only the key picture, the same settings can be applied to all images in that sequence. Press the **MENU** button after displaying individual images to apply settings to individual images.

# Editing Still Images

## Editing Features

Images can be easily edited with this camera using the functions below. Edited images are stored as separate files (📷90).

Editing function	Application
Quick retouch (📷12)	Easily create a copy with enhanced contrast and richer colors.
D-Lighting (📷12)	Create a copy of the current picture with enhanced brightness and contrast, brightening dark portions of the picture.
Skin softening (📷13)	Make the facial skin tones softer.
Filter effects (📷14)	Apply a variety of effects using digital filter. The available effects are <b>Soft</b> , <b>Selective color</b> , <b>Cross screen</b> , <b>Fisheye</b> , <b>Miniature effect</b> , <b>Painting</b> and <b>Vignette</b> .
Small picture (📷15)	Create a small copy of pictures suitable for uses such as e-mail attachments.
Crop (📷16)	Crop a portion of the picture. Use to zoom in on a subject or arrange a composition.



### Original Pictures and Edited Copies

- Copies created with editing functions are not deleted if the original pictures are deleted. The original pictures are not deleted if copies created with editing functions are deleted.
- Edited copies are stored with the same shooting date and time as the original.
- Even if the pictures that are marked for **Print order** (📷52) or **Protect** (📷55) are used for editing, these settings are not reflected on the edited copies.

### More Information

See "File and Folder Names" (📷90) for more information.

## Notes on Image Editing

- The following pictures cannot be edited.
  - Pictures with 16:9, 3:2 or 1:1 aspect ratio
  - Pictures taken using **Easy panorama** or **3D photography**
  - Pictures taken with cameras other than the COOLPIX P520
- When no faces are detected in the picture, skin softening cannot be applied.
- If a copy created using the COOLPIX P520 is viewed on a different digital camera, it may not be possible to display the picture properly or transfer it to a computer.
- Editing functions are not available when there is not enough free space in the internal memory or on the memory card.
- For a sequence displayed using the key picture only setting ()8), perform one of the following operations before editing.
  - Press the  button to display individual images, and then select an image in the sequence.
  - Set **Sequence display options** ()58) to **Individual pictures** so that each image is displayed individually, and then select an image.

## Restrictions on Image Editing

The following restrictions apply when editing pictures that were created by editing.

Editing functions used	Editing functions to add
Quick retouch D-Lighting	Skin softening, Filter effects, Small picture or Crop can be used. Quick retouch and D-Lighting cannot be used in combination with each other.
Skin softening Filter effects	Additional editing functions can be used.
Small picture Crop	No additional editing functions can be used.

- Copies created by editing cannot be edited again using the same editing function.
- To use an editing function together with small picture or crop, use the other editing function first, and use small picture or crop as the last editing function performed on that picture.
- Pictures that were taken using skin softening can be edited using skin softening.
- Pictures that were extracted from a movie cannot be edited using the quick retouch or skin softening function.

## Quick Retouch: Enhancing Contrast and Saturation

Select a picture (📖32) → MENU button (📖10) →  Quick retouch

Press the multi selector ▲ or ▼ to choose the setting level, and press the  button.

- The original version is displayed on the left and the edited version is displayed on the right.
- To cancel, press ◀.
- Quick retouched copies are stored as separate files and recognized by the  icon displayed in playback mode (📖14).

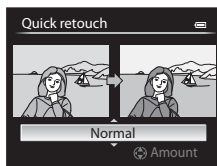

## D-Lighting: Enhancing Brightness and Contrast

Select a picture (📖32) → MENU button (📖10) →  D-Lighting

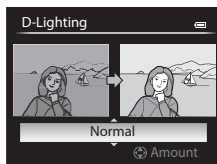

Press the multi selector ▲ or ▼ to choose the setting level, and press the  button.

- The original version is displayed on the left and the edited version is displayed on the right.
- To cancel, press ◀.
- D-Lighting copies are stored as separate files and recognized by the  icon displayed in playback mode (📖14).





## Skin Softening: Softening Skin Tones



Select a picture (32) → MENU button (10) →  Skin softening

### 1 Press the multi selector ▲ or ▼ to choose the setting level, and press the button.

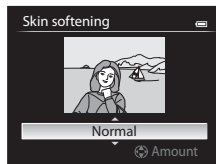
- A confirmation screen is displayed, and the image is displayed zoomed in on the face edited by skin softening.
- To cancel, press ◀.



### 2 Confirm the results and press the button.

- Up to 12 faces, in order of proximity to the center of the frame, can be enhanced.
- When multiple faces are edited using skin softening, use the multi selector ◀ or ▶ to switch the face that is displayed.
- To adjust the extent of skin softening, press the MENU button and return to step 1.
- Copies created by editing with skin softening are stored as separate files and recognized by the  icon displayed in playback mode (14).

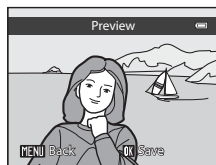

### Notes on Skin Softening

- Depending on conditions such as the direction the subject is facing or the brightness of the face, the face may not be detected properly, or the desired effect may not be achieved.
- If no faces are detected in the image, a warning is displayed and the screen returns to the playback menu.

## Filter Effects: Applying Digital Filter Effects

Select a picture (📖32) → MENU button (📖10) → 🎛️ Filter effects

Option	Description
Soft	Gently soften the focus of the image from the center to the edge. In pictures taken with face detection (📖80) or pet detection (📖44) selected, areas around faces will be blurred.
Selective color	Keep only selected image colors and makes other colors black-and-white.
Cross screen	Produce star-like rays of light that radiate outward from bright objects such as sunlight reflections and city lights. Suitable for night scenes.
Fisheye	Create images that look like they were shot with a fisheye lens. Suitable for pictures shot in macro mode.
Miniature effect	Create images that look like close-up photos of a diorama. Suitable for pictures shot while looking down from a high location, with the main subject near the center of the frame.
Painting	Create images with the ambience of paintings.
Vignette	Create images by lowering the peripheral light intensity from the center to the edges of an image.

**1** Press the multi selector ▲ or ▼ to choose the filter effect type and press the Ⓞ button.

- When **Cross screen**, **Fisheye**, **Miniature effect**, **Painting** or **Vignette** is selected, proceed to step 3.

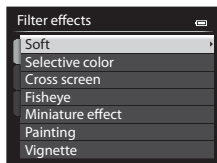

**2** Adjust the effect and press the Ⓞ button.

- **Soft:** Press ▲ or ▼ to choose the extent of the effect.
- **Selective color:** Press ▲ or ▼ to select the color to keep.

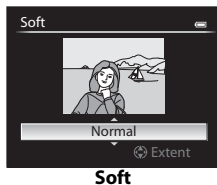





**3** Check the effect and press the Ⓞ button.

- To cancel, press ◀.
- Copies created by editing with filter effect are stored as separate files and recognized by the 🎞️ icon displayed in playback mode (📖14).





## Small Picture: Reducing the Size of an Image

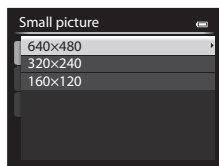

Select a picture (32) → MENU button (10) →  Small picture

**1** Press the multi selector ▲ or ▼ to choose the desired copy size and press the  button.

- The available sizes are **640×480**, **320×240** and **160×120**.



**2** Choose **Yes** and press the  button.

- The created copies are stored as separate files (compression ratio of about 1:16).
- Images created using small picture are displayed as small images in playback mode and  is displayed (14).

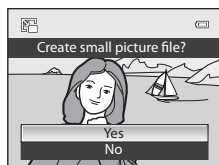

## ✂ Crop: Creating a Cropped Copy

Create a copy containing only the portion visible on the monitor screen when **MENU** ✂ is displayed with playback zoom (📖82) enabled.

**1** Enlarge the picture for cropping (📖82).

**2** Refine copy composition.

- Rotate the zoom control toward **T** (📐) or **W** (📐) to adjust the zoom ratio.
- Press the multi selector ▲, ▼, ◀ or ▶ to scroll the picture until only the portion you want to copy is visible on the monitor.



**3** Press the **MENU** button.

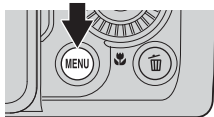

**4** Use the multi selector to choose **Yes** and press the **OK** button.

- Cropped copies are stored as separate files and recognized by the ✂ icon displayed in playback mode (📖14).



### ✂ Image Size

The narrower the cropping range, the smaller the size (amount of pixels) of the cropped picture copy. When the image size setting for a cropped copy is 320 × 240 or 160 × 120, a small image is displayed in playback mode.

### ✂ Cropping the Picture in its Current “Tall” Orientation

Use the **Rotate image** option (📐55) to rotate the picture so that it is displayed in landscape orientation. After cropping the picture, rotate the cropped picture back to “tall” orientation. The picture displayed in “tall” orientation can be cropped by zooming in on the picture until the black bars displayed on the both sides of the monitor disappear. The cropped picture is displayed in landscape orientation.

## Connecting the Camera to a TV (Viewing Images on a TV)

Connect the camera to a television to play back pictures on the television. If your television is equipped with an HDMI connector, you can connect it to the camera with a commercially available HDMI cable to play back pictures.

**1** Turn off the camera.

**2** Connect the camera to the TV.

### When connecting using the included Audio Video Cable EG-CP16

- Connect the yellow plug to the video-in jack on the TV, and the red and white plugs to the audio-in jacks.

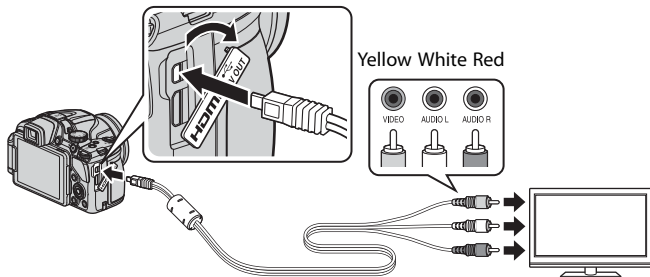

### When connecting using a commercially available HDMI cable

- Connect the plug to the HDMI input connector on the TV.

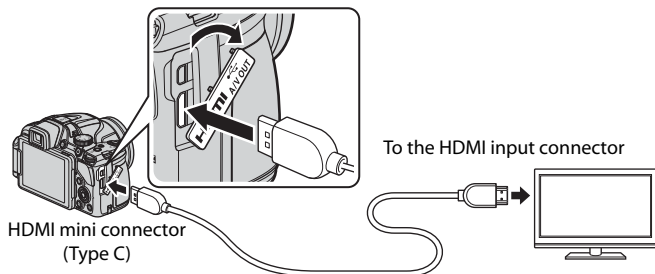

### 3 Tune the television to the video channel.

- See the instruction manual provided with your TV for details.

### 4 Hold down the button to turn on the camera.

- The camera enters playback mode, and the recorded pictures are displayed on the TV.
- While the camera is connected to the TV, the monitor remains off.

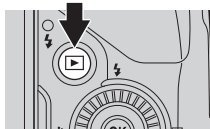

### **Note on Connecting an HDMI Cable**

An HDMI cable is not included. Use a commercially available HDMI cable to connect the camera to a TV. The output terminal on this camera is an HDMI mini connector (Type C). When purchasing an HDMI cable, be sure that the device end of the cable is an HDMI mini connector.

### **Note on Connecting the Cable**

When connecting the cable, be sure that the plug is oriented correctly. Do not force the plug into the camera. When disconnecting the cable, do not pull the plug at an angle.

### **When Nothing Appears on the TV**

Make sure that **TV settings** (75) in the setup menu is appropriate for your television.

### **Using the TV's Remote Control (HDMI Device Control)**

The remote control of a TV that conforms to the HDMI-CEC standard can be used to operate the camera during playback.

Instead of the multi selector or zoom control, the remote control can be used for picture selection, playback/pause of movies, switching between full-frame playback and 4-picture thumbnail display, etc.

- Set **HDMI device control** (75) of **TV settings** to **On** (default setting) in the setup menu, and connect the camera to the TV with an HDMI cable.
- Point the remote control at the TV to operate.
- See your TV's instruction manual or other related documentation to check whether your TV conforms to the HDMI-CEC standard.

### **HDMI and HDMI-CEC**

"HDMI" is an abbreviation of High-Definition Multimedia Interface, which is one type of multimedia interface.

"HDMI-CEC" is an abbreviation of HDMI-Consumer Electronics Control, which enables operations to be linked between compatible devices.

## Connecting the Camera to a Printer (Direct Print)

Users of PictBridge-compatible (🔌22) printers can connect the camera directly to the printer and print pictures without using a computer.

### Connecting the Camera to a Printer

- 1 Turn off the camera.
- 2 Turn on the printer.
  - Check the printer settings.
- 3 Connect the camera to the printer using the included USB cable.
  - Be sure that the plug is oriented correctly. When disconnecting the cable, do not pull the plug at an angle.

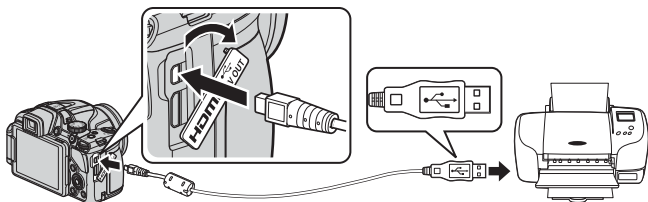

- 4 The camera is automatically turned on.
  - When connected correctly, the **PictBridge** startup screen (①) is displayed on the monitor screen of the camera. Then the **Print selection** screen (②) is displayed.

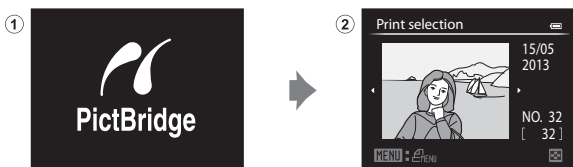

#### ✔ If the PictBridge Startup Screen Is Not Displayed

Turn the camera off and disconnect the USB cable. Set the **Charge by computer** option (🔌76) in the camera's setup menu to **Off** and reconnect the cable.

#### ✔ Notes on Power Source

- When connecting the camera to a printer, use a fully charged battery to prevent the camera from turning off unexpectedly.
- If the AC Adapter EH-62A (available separately) (🔌92) is used, the COOLPIX P520 can be powered from an electrical outlet. Do not, under any circumstances, use an AC adapter other than the EH-62A. Failure to observe this precaution could result in overheating or damage to the camera.

## Printing Individual Images

After connecting the camera to the printer correctly (🔌19), print pictures by following the procedure below.

### 1 Use the multi selector to choose the picture to be printed, and press the **OK** button.

- Rotate the zoom control toward **W** (📷) to display 12 thumbnails, or toward **T** (🔍) to switch back to full-frame playback mode.

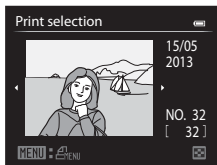

### 2 Set the number of copies and paper size.

- Choose **Copies** and press the **OK** button to set the number of copies (up to 9).
- Choose **Paper size** and press the **OK** button to set the paper size (🔌23).  
To prioritize the printer settings, select **Default**.

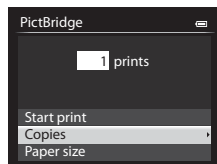

### 3 Choose **Start print** and press the **OK** button.

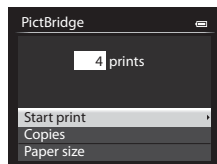

### 4 Printing starts.

- The monitor display returns to that shown in step 1 when printing is complete.
- When printing is complete, turn the camera off and then disconnect the USB cable.

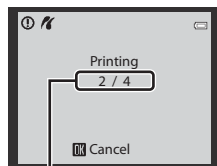

Current print/total number of prints



## Printing Multiple Images

After connecting the camera to the printer correctly (📷19), print pictures by following the procedure below.

- 1 When the **Print selection** screen is displayed, press the **MENU** button.

- To exit the print menu, press the **MENU** button.

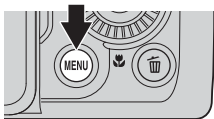

- 2 Choose **Print selection**, **Print all images** or **DPOF printing** and press the **OK** button.

- Choose **Paper size** and press the **OK** button to set the paper size (📷23).  
To prioritize the printer settings, select **Default**.

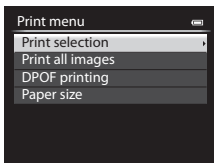

### Print selection

Choose the pictures (up to a maximum of 99) and number of copies (up to 9 per picture).

- Press the multi selector ◀ or ▶ to choose the pictures, and press ▲ or ▼ to set the number of copies for each.
- Pictures selected for printing can be recognized by the check mark icon and the numeral indicating the number of copies to be printed. If the numeral is set to 0, the print selection is cancelled.
- Rotate the zoom control toward **T** (📷) to switch to full-frame playback mode, or **W** (📷) to switch to 12-thumbnail display.
- Press the **OK** button when setting is complete.
- When the menu shown on the right is displayed, choose **Start print** and press the **OK** button to start printing.

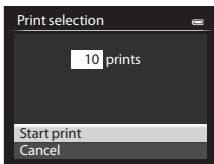

### Print all images

All pictures stored in the internal memory or on the memory card are printed one per each.

- When the menu shown on the right is displayed, choose **Start print** and press the **OK** button to start printing.

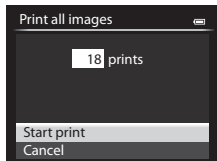

### DPOF printing

Pictures for which a print order was created in **Print order** option (052) can be printed.

- When the menu shown on the right is displayed, choose **Start print** and press the **OK** button to start printing.
- To view the current print order, choose **View images** and press the **OK** button. To print pictures, press the **OK** button again.

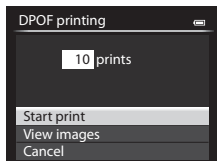

## 3 Printing starts.

- The monitor display returns to that shown in step 2 when printing is complete.

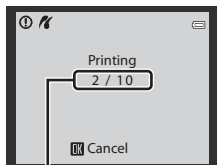

Current print/total number of prints

 **More Information**

See "Printing Images of Size 1:1" (📖74) for more information.

 **Paper Size**

The camera supports the following paper sizes: **Default** (the default paper size for the current printer), **3.5×5 in.**, **5×7 in.**, **100×150 mm**, **4×6 in.**, **8×10 in.**, **Letter**, **A3**, and **A4**. Only sizes supported by the current printer are displayed.

 **Printing Pictures**

In addition to printing pictures transferred to a computer and printing pictures with a direct camera-to-printer connection, the following options are also available for printing pictures recorded on the memory card:

- Insert a memory card into a DPOF-compatible printer's card slot.
- Take a memory card to a digital photo lab.

For printing using these methods, specify the pictures and the number of prints each using the **Print order** (🔍52) option in the playback menu.

## Editing Movies

### Extracting Only the Desired Portions of the Movie

Only the desired portions of a recorded movie can be saved as a separate file (except for movies recorded with **1080/60i**, **1080/50i**, **iFrame 540/30p** or **iFrame 540/25p**).

**1** Play back the movie to be edited and pause at the start point of the portion that is to be extracted (📖97).

**2** Use the multi selector ◀ or ▶ to choose ✂ on the playback control, and press the Ⓞ button.

- The movie editing screen is displayed.

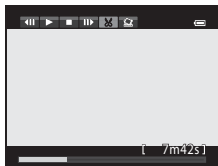

**3** Press ▲ or ▼ to choose ⏪ (choose start point) on the editing playback control.

- Rotate the multi selector or press ◀ or ▶ to adjust the start position.
- To cancel, press ▲ or ▼ to choose ⏪ (back) and press the Ⓞ button.

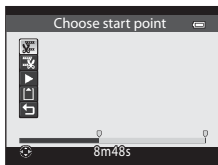

**4** Press ▲ or ▼ to choose ⏩ (choose end point).

- Rotate the multi selector or press ◀ or ▶ to move the end point at the right end to the end position of the required section.
- To check the playback of the movie in the specified range before saving it, choose ▶ (preview) and press the Ⓞ button. During preview playback, the volume can be adjusted with the zoom control T/W. Use the multi selector to fast forward or rewind. To stop the preview playback, press the Ⓞ button again.

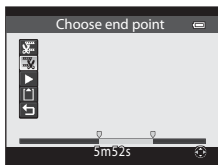

**5** After finishing the settings, press ▲ or ▼ to choose ⏹ (save) and press the Ⓞ button.

**6** Choose **Yes** and press the Ⓞ button.

- The edited movie is saved.

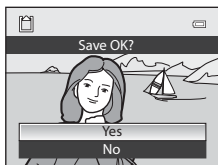

## ✓ Notes on Editing Movies





- Use a fully charged battery to prevent the camera from turning off during editing. When the battery level is , movie editing is not possible.
- Once a movie is created through editing, it cannot be used again for extracting a movie. To extract another range, select and edit the original movie.
- Because the edited movies are extracted in one-second units, they may vary slightly from the set start point and end point. Sections shorter than two seconds cannot be extracted.
- Editing functions are not available when there is not enough free space in the internal memory or on the memory card.

## ✎ More Information





See "File and Folder Names" (90) for more information.

## Saving a Frame from a Movie as a Still Picture

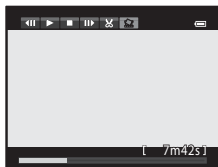
A frame from a recorded movie can be extracted and saved as a still picture (except for movies recorded with  **1080/60i**,  **1080/50i**,  **iFrame 540/30p** or **iFrame 540/25p**).

- Pause a movie and display the frame to be extracted (97).
- Choose  on the playback control with the multi selector  or  and press the  button.



- When the confirmation dialog is displayed, choose **Yes** and press the  button to save.
- The still picture is saved with **Normal** as the image quality. The image size is determined by the type (image size) (48) of the original movie. For example, the image size of a still picture saved from a movie recorded with  **1080★/30p** or **1080★/25p** is  (1920 × 1080 pixels).

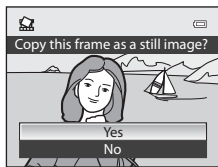

## Shooting Menu (P, S, A or M Mode)







### Image Quality and Image Size

To set the image quality and image size, see “Changing the Image Quality and Image Size” (📖 72).

### Picture Control (COOLPIX Picture Control)

Rotate the mode dial to **P, S, A, M** or **U** → MENU button → **P, S, A, M** or **U** tab (📖10)  
→ Picture Control

Change the settings for image recording according to the shooting scene or your preferences. Sharpness, contrast and saturation can be adjusted in detail.

Option	Description
 <b>Standard</b> (default setting)	Standard processing for balanced results. Recommended for most situations.
 <b>Neutral</b>	Minimal processing for natural results. Choose for pictures that will later be extensively processed or retouched.
 <b>Vivid</b>	Pictures are enhanced for a vivid, photoprint effect. Choose for pictures that emphasize primary colors, such as blue, red, and green.
 <b>Monochrome</b>	Take monochrome photographs such as in black-and-white or sepia.
 <b>Custom 1</b> *	Change to the setting for <b>Custom 1</b> in COOLPIX Custom Picture Control.
 <b>Custom 2</b> *	Change to the setting for <b>Custom 2</b> in COOLPIX Custom Picture Control.

\* Only displayed when the setting customized in **Custom Picture Control** (🔧30) has been registered.

The icon for the current setting other than **Standard** is displayed on the monitor (📖12).

### ✔ COOLPIX Picture Control

- The COOLPIX Picture Control feature of the COOLPIX P520 cannot be used with other makes of cameras, Capture NX, Capture NX 2 and ViewNX 2 Picture Control feature.
- Some features cannot be used in combination with other menu settings. See “Features Not Available in Combination” (📖75) for more information.

## Customizing Existing COOLPIX Picture Controls: Quick Adjust and Manual Adjust

COOLPIX Picture Control can be customized using Quick adjust, which allows for balanced adjustment of sharpness, contrast, saturation and other image editing components, or manual adjust, which allows for detailed adjusting of the components individually.

- 1 Use the multi selector to choose the type of COOLPIX Picture Control and press the **OK** button.

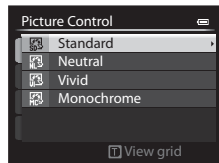

- 2 Press **▲** or **▼** to highlight the desired setting (6-28) and press **◀** or **▶** to choose a value.

- Press the **OK** button to set the value.
- When COOLPIX Picture Controls are modified from the default settings, an asterisk (\*) is displayed after the options in the Picture Control Setting menu.
- To change the values to the default setting, select **Reset** and press the **OK** button.

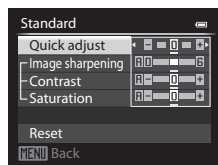

### View Grid of COOLPIX Picture Control

When the zoom control is rotated toward **T (Q)** while the screen in step 1 of the above procedure is displayed, the contrast and saturation are displayed using a grid. The vertical axis indicates the contrast level, and the horizontal axis indicates the saturation. Rotate the zoom control toward **T (Q)** again to return to the previous screen.

The COOLPIX Picture Control grid displays the current and default settings in relation to the other COOLPIX Picture Controls.

- Rotate the multi selector to change to other COOLPIX Picture Controls.
- Press the **OK** button to display the COOLPIX Picture Control Setting screen (step 2 above).
- For **Monochrome**, the grid is displayed for contrast only.
- The grid is also displayed when adjusting **Contrast** or **Saturation** with manual adjustment.

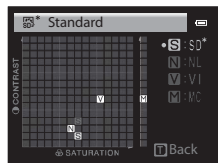

## Types of Quick Adjust and Manual Adjust

Option	Description
Quick adjust <sup>1</sup>	Adjust the sharpness, contrast and saturation levels automatically. Five levels of adjustment are available from <b>-2</b> to <b>+2</b> . Choose from options between <b>-2</b> and <b>+2</b> to reduce or emphasize the effect of the selected COOLPIX Picture Control. The default setting is <b>0</b> .
Image sharpening	Control how much outlines are sharpened during shooting. Choose <b>A</b> (auto) to adjust sharpening automatically, or choose from seven levels of adjustment between <b>0</b> (no sharpening) and <b>6</b> . The higher the number, the sharper the image, and the lower the number, the softer the image. The default setting is <b>3</b> for <b>Standard</b> or <b>Monochrome</b> , <b>2</b> for <b>Neutral</b> and <b>4</b> for <b>Vivid</b> .
Contrast	Control the contrast. Choose <b>A</b> (auto) to adjust the contrast automatically according to the type of scene, or choose from seven levels of adjustment between <b>-3</b> and <b>+3</b> . Setting to the – side makes it into an image with a softer appearance, and setting to the + side gives it a harder appearance. Choose lower values to prevent highlights in portrait subjects from being “washed out” in direct sunlight, higher values to preserve detail in misty landscapes and other low-contrast subjects. The default setting is <b>0</b> .
Saturation <sup>2</sup>	Control the vividness of colors. Choose <b>A</b> (auto) to adjust saturation automatically according to the type of scene, or seven levels of adjustment can be done by choosing from values between <b>-3</b> and <b>+3</b> . Setting to the – side reduces the vividness, and setting to the + side increases the vividness. The default setting is <b>0</b> .
Filter effects <sup>3</sup>	Simulate the effect of color filters on monochrome photographs. Choose from <b>OFF</b> (the default setting), <b>Y</b> (yellow), <b>O</b> (orange), <b>R</b> (red), and <b>G</b> (green). <b>Y, O, R:</b> Enhance contrast. Can be used to tone down the brightness of the sky in landscape photographs. The contrast is strengthened in the order <b>Y</b> → <b>O</b> → <b>R</b> . <b>G:</b> Soften skin tones. Suitable for portraits.



Option	Description
Toning <sup>3</sup>	Control the tint used in monochrome photographs from <b>B&amp;W</b> (black-and-white, the default setting), <b>Sepia</b> , and <b>Cyanotype</b> (blue-tinted monochrome). Pressing the multi selector ▼ when <b>Sepia</b> or <b>Cyanotype</b> is selected enables you to choose from seven levels of saturation. Press ◀ or ▶ to adjust the saturation.

- 1 Quick adjust is not available in **Neutral**, **Monochrome**, **Custom 1** and **Custom 2**. The values set manually are disabled if quick adjust is used after manual setting.
- 2 Not displayed for **Monochrome**.
- 3 Only displayed for **Monochrome**.

### **Note on Image Sharpening**

The effects of **Image sharpening** cannot be previewed on the monitor during shooting. Check the results in playback mode.

### **Note on Contrast**

When **Active D-Lighting** (46) is set to settings other than **Off**, the  mark is displayed for **Contrast** and contrast cannot be adjusted.

### **Contrast, Saturation and A (Auto)**

- Results for contrast and saturation vary with the exposure, and the position and size of the subject in the frame.
- The setting for the COOLPIX Picture Control which has **A** (auto) selected for either **Contrast** or **Saturation** is displayed in green in the COOLPIX Picture Control grid.

### **Options that Can Be Adjusted in Custom 1 and Custom 2**

The same option as that of the original COOLPIX Picture Control can be adjusted if **Custom 1** or **Custom 2** is selected.

## Custom Picture Control (COOLPIX Custom Picture Control)

Rotate the mode dial to **P**, **S**, **A**, **M** or **U** → MENU button → **P**, **S**, **A**, **M** or **U** tab (📖10)  
→ Custom Picture Control

The picture editing options created by customizing COOLPIX Custom Picture Controls can be registered up to 2 options. The registered options can be displayed as **Custom 1** and **Custom 2** in COOLPIX Custom Picture Control.

### Creating COOLPIX Custom Picture Controls

- 1 Use the multi selector to choose **Edit and save**, and press the **OK** button.

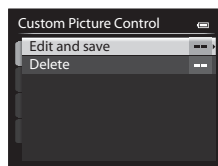

- 2 Choose the original COOLPIX Picture Control (🔍27) to be edited, and press the **OK** button.

- 3 Press **▲** or **▼** to highlight the desired setting and press **◀** or **▶** to choose a value (🔍27).

- The options are the same as those for adjusting the COOLPIX Picture Control.
- Press the **OK** button to display the **Save as** screen.
- To change the values to the default setting, select **Reset** and press the **OK** button.

- 4 Choose the registration destination and press the **OK** button.

- The COOLPIX Custom Picture Control is registered.
- **Custom 1** or **Custom 2** can be selected from the **Picture Control** and **Custom Picture Control** selection screen after registration.

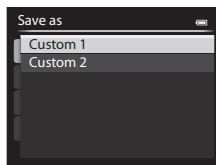

### Deleting COOLPIX Custom Picture Controls

Select **Delete** in step 1 of "Creating COOLPIX Custom Picture Controls" to delete a registered Custom Picture Control.

## White Balance (Adjusting Hue)

Rotate the mode dial to **P, S, A, M** or **U** → MENU button → **P, S, A, M** or **U** tab (📖10)  
→ White balance

The color of light reflected from an object varies with the color of the light source. The human brain is able to adapt to changes in the color of the light source, with the result that white objects appear white whether seen in the shade, direct sunlight, or under incandescent lighting. Digital cameras can mimic this adjustment of the human eye by processing images according to the color of the light source. This is known as “white balance.” For natural colors, select a white balance setting that matches the light source before shooting.

Although the default setting, **Auto (normal)**, can be used under most types of lighting, you can apply the white balance setting suited to a particular light source to achieve more accurate results.

Option	Description
<b>AUTO1</b> Auto (normal) (default setting)	White balance is automatically adjusted to suit lighting conditions. Best choice in most situations. When set to <b>Auto (warm lighting)</b> , the images are preserved with warm colors if they are shot under an incandescent light source. When using the flash, according to the brightness of the flash, the images are adjusted to suitable white balance.
<b>AUTO2</b> Auto (warm lighting)	
<b>PRE</b> Preset manual	Useful when shooting under unusual lighting. See “Using Preset Manual” for more information (📖32).
☀️ Daylight*	White balance adjusted for direct sunlight.
💡 Incandescent*	Use under incandescent lighting.
💡 Fluorescent (1 to 3)	Use under most types of fluorescent lighting. Choose one of <b>1</b> (white fluorescent), <b>2</b> (daylight white/neutral fluorescent) and <b>3</b> (daylight fluorescent).
☁️ Cloudy*	Use when taking pictures under overcast skies.
🔆 Flash*	Use with the flash.

\* Fine adjustments in seven steps are available. Apply positive (+) to increase blue hue and negative (-) to increase red hue.

The icon for the current setting other than **Auto (normal)** is displayed on the monitor (📖12).

### ✓ Notes on White Balance

- At white-balance settings other than **Auto (normal)**, **Auto (warm lighting)** or **Flash**, lower the flash.
- Some features cannot be used in combination with other menu settings. See “Features Not Available in Combination” (📖75) for more information.

## Using Preset Manual

Use when you want to make pictures taken under unusual lighting conditions (e.g., lamps with reddish-light) look as though they were shot in normal light.

Use the procedure below to measure the white balance value under the lighting used during shooting.

**1** Place a white or gray reference object under the lighting that will be used during shooting.

**2** Display the shooting menu (📖67), use the multi selector to set **White balance to PRE Preset manual**, then press the **OK** button.

- The lens extends to the zoom position for measurement.

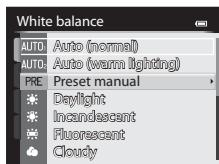

**3** Choose **Measure**.

- To apply the most recently measured white balance value, select **Cancel** and press the **OK** button. The most recently measured white balance value will be set without re-measuring the value.

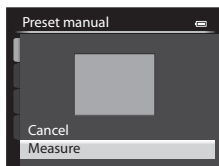

**4** Frame a white or gray reference object in the reference object frame and press the **OK** button.

- The shutter is released and the new white balance preset value is set (no picture is recorded).

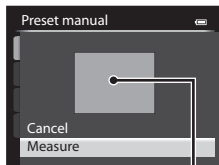

Reference object frame

### ✔ Note on Preset Manual



The camera cannot measure a white balance value for when the flash fires. When shooting with the flash, set **White balance to Auto (normal), Auto (warm lighting) or Flash**.

## Metering

Rotate the mode dial to **P, S, A, M** or **U** → MENU button → **P, S, A, M** or **U** tab (📖10)  
→ Metering

The process of measuring the brightness of the subject to determine the exposure is known as “metering.”

Use this option to choose how the camera meters exposure.

Option	Description
 <b>Matrix (default setting)</b>	The camera uses a wide area of the screen for metering. This metering mode provides the appropriate exposure for a variety of shooting conditions. Recommended for typical shooting.
 <b>Center-weighted</b>	The camera meters the entire frame but assigns greatest weight to the subject at the center of the frame. The classic metering for portraits; it preserves background details while letting lighting conditions at the center of the frame determine exposure. Can be used with focus lock (📖81) to meter off-center subjects.
 <b>Spot</b>	The camera meters the area shown by the circle at the center of the frame. This can be used when the subject is much lighter or darker than the background. Ensure that the subject is within the area shown by the circle when shooting. Can be used with focus lock (📖81) to meter off-center subjects.

### ✓ Notes on Metering

- When the digital zoom is in effect, **Metering** is set to **Center-weighted** or **Spot** depending on the magnification of an enlargement.
- If **AF area mode** (📖40) is set to **Manual** when **Metering** is set to **Matrix**, the camera meters by assigning greatest weight to the focus area.
- Some features cannot be used in combination with other menu settings. See “Features Not Available in Combination” (📖75) for more information.









### Metering Area





When **Center-weighted** or **Spot** is selected for **Metering**, the metering range guide (📖12) is displayed (except when digital zoom is used).

## Continuous Shooting

Rotate the mode dial to **P, S, A, M** or **U** → MENU button → **P, S, A, M** or **U** tab (📖10)  
→ Continuous

Change the settings for continuous shooting and BSS (Best Shot Selector).

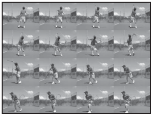
Option	Description
 Single (default setting)	One picture is shot each time the shutter-release button is pressed.
 Continuous H	<p>Pictures are continuously shot while the shutter-release button is pressed all the way. Shooting ends when the shutter-release button is released or when the maximum number of continuous shooting frames is reached.</p> <ul style="list-style-type: none"> <li>• <b>Continuous H:</b> Up to 7 pictures are continuously shot at a rate of about 7 frames per second.</li> <li>• <b>Continuous L:</b> Up to 30 pictures are continuously shot at a rate of about 1 frame per second (when image quality is set to <b>Normal</b> and image size is set to  <b>4896×3672</b>).</li> </ul>
 Continuous L	
 Pre-shooting cache	<p>Pre-shooting cache makes it easy to capture perfect moments, by saving images from before the shutter-release button was pressed all the way. Pre-shooting cache shooting begins when the shutter-release button is pressed halfway, and shooting continues while the shutter-release button is pressed all the way (36).</p> <ul style="list-style-type: none"> <li>• Frame rate: up to 15 fps</li> <li>• Number of frames: up to 20 frames (including up to 5 frames captured in the pre-shooting cache)</li> </ul> <p>Shooting ends when the shutter-release button is released or when the maximum number of frames has been shot. The image quality is fixed at <b>Normal</b> and the image size is fixed at  (2048×1536 pixels).</p>
120 Continuous H: 120 fps	<p>Each time the shutter-release button is pressed all the way, pictures are continuously shot using a high shutter speed.</p> <ul style="list-style-type: none"> <li>• <b>Continuous H: 120 fps:</b> 60 frames are captured at a speed of about 1/125 seconds or faster.</li> </ul> <p>The image size is fixed at <b>VGA</b> (640 × 480 pixels).</p>
60 Continuous H: 60 fps	<ul style="list-style-type: none"> <li>• <b>Continuous H: 60 fps:</b> 60 frames are captured at a speed of about 1/60 seconds or faster.</li> </ul> <p>The image size to be recorded is fixed at  (1920 × 1080 pixels).</p>
<b>BSS</b> BSS (Best Shot Selector)	BSS is recommended for shooting under low lighting without the flash, with the camera zoomed in, or in other situations in which camera shake is likely to blur pictures. Keep pressing the shutter-release button all the way, and up to 10 pictures are shot and the camera automatically selects and saves only the sharpest picture in the series.

Option	Description
 Multi-shot 16	<p>Each time the shutter-release button is pressed all the way, the camera shoots 16 pictures at a rate of about 30 frames per second and arranges them in a single picture.</p> <ul style="list-style-type: none"> <li>The image quality is fixed at <b>Normal</b> and the image size is fixed at  (2560 × 1920 pixels).</li> <li>The digital zoom is not available.</li> </ul> 
 Intvl timer shooting	<p>The camera shoots still pictures automatically at the specified interval ( 36).</p>

The icon for the current setting other than **Single** is displayed on the monitor ( 12).

### Notes on Continuous Shooting

- Focus, exposure and white balance are fixed at the values determined with the first shot in each series.
- The frame rate may become slower depending on the image quality, image size, memory card type or shooting conditions.
- Some features cannot be used in combination with other menu settings. See “Features Not Available in Combination” ( 75) for more information.

### Notes on Continuous H

- It may take some time to save the images after shooting. The amount of time it takes to finish saving the captured images depends on the number of images, the write speed of the memory card, etc.
- When ISO sensitivity increases, noise may appear in captured images.
- Banding or variance in brightness or hue may occur in images that were captured under lighting that flashes quickly at high speeds, such as fluorescent, mercury-vapor, or sodium-vapor lighting.

### Note on BSS

**BSS** is suited for shooting stationary subjects. BSS may not produce the desired results if the subject moves or the composition changes.

### Note on Multi-shot 16

Banding or variance in brightness or hue may occur in images that were captured under lighting that flashes quickly at high speeds, such as fluorescent, mercury-vapor, or sodium-vapor lighting.

## Pre-shooting Cache

If **Pre-shooting cache** is selected, shooting begins when the shutter-release button is pressed halfway for 0.5 seconds or longer, and images captured before the shutter-release button is pressed all the way are saved along with images captured after the shutter-release button is pressed all the way. Up to 5 images can be saved in the pre-shooting cache.

The current pre-shooting cache setting is indicated by an icon when shooting (12). The pre-shooting cache icon lights in green while the shutter-release button is pressed halfway.

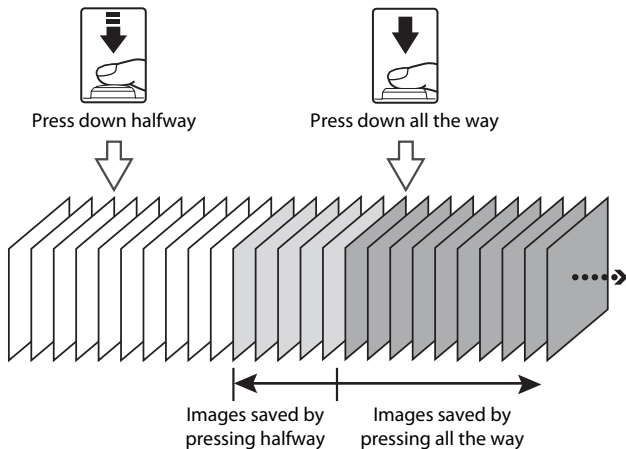



- If the number of exposures remaining is less than 6, the pictures taken with the pre-shooting cache are not recorded. Before shooting, check that there are 6 or more exposures remaining.

## Interval Timer Shooting

Rotate the mode dial to **P**, **S**, **A**, **M** or **U** → MENU button → **P**, **S**, **A**, **M** or **U** tab (10) → Continuous

Choose from **30 s**, **1 min**, **5 min** or **10 min**.

- 1 Use the multi selector to select  **Intvl timer shooting** for the **Continuous** setting, and then press the  button.

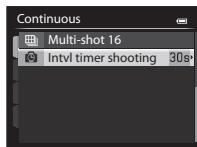



- 2** Choose the interval between each shot and press the **OK** button.

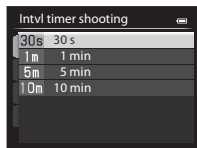

- 3** Press the **MENU** button.

- The camera returns to the shooting screen.

- 4** Press the shutter-release button all the way to shoot the first picture and start interval timer shooting.

- The monitor is turned off and the power-on lamp flashes between shots.
- The monitor reactivates automatically immediately before the next picture is shot.

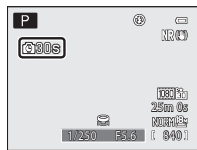

- 5** Press the shutter-release button all the way again to finish shooting.

- Shooting finishes automatically if the internal memory or memory card becomes full.

### **✓** Notes on Interval Timer Shooting

- To prevent the camera from turning off unexpectedly during shooting, use a fully charged battery.
- If the AC Adapter EH-62A (available separately) (E92) is used, the COOLPIX P520 can be powered from an electrical outlet. Do not, under any circumstances, use an AC adapter other than the EH-62A. Failure to observe this precaution could result in overheating or damage to the camera.
- Do not rotate the mode dial to a different setting while performing interval timer shooting.

### **✍** More Information

See "File and Folder Names" (E90) for more information.

## ISO Sensitivity

Rotate the mode dial to **P**, **S**, **A**, **M** or **U** → MENU button → **P**, **S**, **A**, **M** or **U** tab (📖10)  
→ ISO sensitivity

The higher the ISO sensitivity, the less light needed for taking pictures. The higher the ISO sensitivity, the darker the subject that can be shot. Additionally, even with subjects of similar brightness, pictures can be taken at faster shutter speeds, and blurring caused by camera shake and subject movement can be reduced.

- Setting the ISO sensitivity to a high level is effective when shooting dark subjects, not using the flash, shooting at the telephoto zoom position and similar situations, but the pictures taken may be slightly grainy.

Option	Description
ISO sensitivity	<ul style="list-style-type: none"> <li>• <b>Auto</b> (default setting): The sensitivity is ISO 80 in bright places; in dark places the camera automatically raises the sensitivity to a maximum of ISO 1600.</li> <li>• <b>Fixed range auto</b>: Choose the range in which the camera automatically adjusts ISO sensitivity from <b>ISO 80-400</b> (default setting) and <b>ISO 80-800</b>. The camera does not raise sensitivity beyond the maximum value in the selected range. Set the maximum value for ISO sensitivity to control “grain” that appears in images.</li> <li>• <b>80 to 3200, Hi 1</b> (equivalent to ISO 6400): ISO sensitivity is fixed at the specified value.</li> </ul>
Minimum shutter speed	When the shooting mode is <b>P</b> or <b>A</b> and <b>ISO sensitivity</b> is set to <b>Auto</b> or <b>Fixed range auto</b> , the shutter speed at which the ISO sensitivity automatic control starts to function (1/125 to 1 second) can be set. The default setting is <b>None</b> . If the exposure is insufficient with the shutter speed that is set here, the ISO sensitivity is increased automatically to obtain the correct exposure. If the exposure is still insufficient even after the ISO sensitivity is increased, the shutter speed slows down.

The icon for the current setting is displayed on the monitor during shooting (📖12).

- When **Auto** is selected, the **ISO** icon is not displayed at ISO 80, but is displayed if the ISO sensitivity automatically increases to higher than 80.
- When **Fixed range auto** is selected, the **ISO** icon and the maximum ISO sensitivity value are displayed.

### ✓ Notes on ISO Sensitivity

- In **M** (Manual) mode, when set to **Auto** or **Fixed range auto** the ISO sensitivity is fixed at ISO 80.
- Some features cannot be used in combination with other menu settings. See “Features Not Available in Combination” (📖75) for more information.

## Exposure Bracketing

Rotate the mode dial to **P**, **S** or **A** → MENU button → **P**, **S** or **A** tab (📖10)  
 → Exposure bracketing

The exposure (brightness) can be changed automatically during continuous shooting. This is effective for shooting when it is difficult to adjust the picture brightness.

Option	Description
±0.3	Camera varies exposure by 0, -0.3, and +0.3 over next three shots. The three shots are taken in sequence when the shutter-release button is pressed all the way.
±0.7	Camera varies exposure by 0, -0.7, and +0.7 over next three shots. The three shots are taken in sequence when the shutter-release button is pressed all the way.
±1.0	Camera varies exposure by 0, -1.0, and +1.0 over next three shots. The three shots are taken in sequence when the shutter-release button is pressed all the way.
Off (default setting)	Exposure bracketing is not performed.

When exposure bracketing is enabled, the current setting is displayed during shooting (📖12). When **Off** is selected, an icon for the current setting is not displayed.



### ✔ Notes on Exposure Bracketing







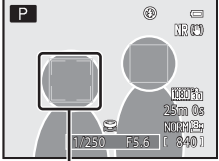

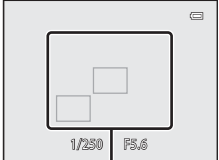





- **Exposure bracketing** is not available in **M** (Manual) mode.
- When exposure compensation (📖64) and **±0.3**, **±0.7** or **±1.0** in **Exposure bracketing** are set simultaneously, the combined exposure compensation values are applied.
- Some features cannot be used in combination with other menu settings. See “Features Not Available in Combination” (📖75) for more information.

## AF Area Mode

Rotate the mode dial to **P, S, A, M** or **U** → MENU button → **P, S, A, M** or **U** tab (10) → AF area mode

You can set how the focus area is determined for autofocus.

Option	Description
 Face priority	<p>The camera detects and focuses on a face (see “Using Face Detection” (180) for more information). If the camera detects multiple faces, the camera focuses on the face closest to the camera. When non-human subjects are photographed, or a subject with which no face can be detected is framed, AF area mode is set to <b>Auto</b>. The camera automatically selects the focus areas (up to 9) that contain the subject closest to the camera.</p>  <p style="text-align: center;">Focus area</p>
 Auto (default setting)	<p>The camera automatically selects the focus areas (up to 9) that contain the subject closest to the camera. Press the shutter-release button halfway to activate the focus area. When the shutter-release button is pressed halfway, the focus area selected by the camera is displayed on the monitor (up to 9 areas).</p>  <p style="text-align: center;">Focus areas</p>

Option	Description
<p> Manual</p>	<p>Choose manually the focus position from 99 areas in the screen. This option is suited to situations in which the intended subject is relatively still and not positioned at the center of the frame. Rotate the multi selector or press , ,  or  to move the focus area to where the subject is, and take a picture.</p> <p>To adjust the following settings, press the  button to temporarily cancel focus area selection, and then adjust each setting.</p> <ul style="list-style-type: none"> <li>- Flash mode, focus mode, self-timer or exposure compensation</li> </ul> <p>To return to the focus area selection screen, press the  button again.</p> <ul style="list-style-type: none"> <li>• At an <b>Image size</b> setting (73) of  <b>3672x3672</b>, 81 focus areas are available.</li> <li>• When <b>Metering</b> (33) is set to <b>Matrix</b>, the camera meters by assigning greatest weight to the focus area.</li> </ul>
<p> Center (normal)</p> <p> Center (wide)</p>	<p>The camera focuses at the center of the frame. The focus area is always displayed at the center of the frame. Two sizes are available for the focus area.</p>
<p> Subject tracking</p>	<p>Subject tracking begins once you select a subject to be focused on, and the focus area will move and follow the subject. See "Using Subject Tracking" (43).</p>

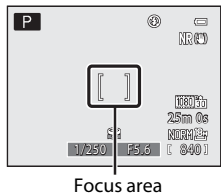
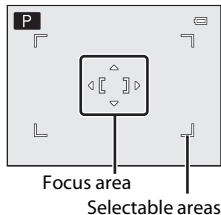

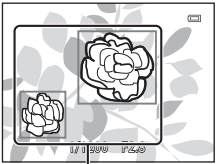
Option	Description
 Target finding AF	<p>When the camera detects the main subject, it focuses on that subject.</p> <p>See “Using the Target Finding AF” (📖 79) for more information.</p> <div data-bbox="682 148 928 330" style="text-align: center;">  <p data-bbox="736 344 847 365">Focus areas</p> </div>

### Notes on AF Area Mode

- When the digital zoom is in effect, the camera focuses on the subject at the center of the frame regardless of the applied **AF area mode** option.
- In some rare cases of shooting subjects for which autofocus does not perform as expected (📖 81), the subject may not be in focus.
- Some features cannot be used in combination with other menu settings. See “Features Not Available in Combination” (📖 75) for more information.
- If the camera does not focus on the desired subject when using a feature that selects and focuses on the subject, such as Target finding AF, set **AF area mode** to **Manual, Center (normal)** or **Center (wide)** and align the focus area with the desired subject. You can also try using focus lock (📖 81).

## Using Subject Tracking

Rotate the mode dial to **P, S, A, M** or **U** → MENU button → **P, S, A, M** or **U** tab (📖10)  
→ AF area mode

Choose this mode to shoot moving subjects. Subject tracking begins once you select a subject to be focused on, and the focus area will move and follow the subject.

### 1 Rotate the multi selector to select Subject tracking, and press the button.

- Press the MENU button after changing the settings and return to the shooting screen.

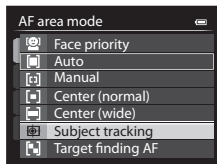

### 2 Frame the subject at the center of the border, and press the button.

- The subject is registered.
- When the camera is unable to focus on the subject, the border lights in red. Change the composition and try again.
- Once the subject is registered, it is framed by a yellow focus area display, and subject tracking begins.
- Press the  button to cancel the registration of the subject.
- If the camera loses sight of the subject, the focus area display disappears; register the subject again.

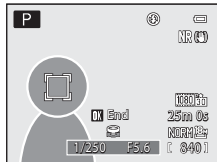
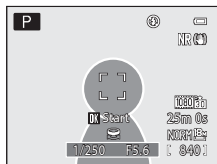

### 3 Press the shutter-release button all the way to take the picture.

- If the camera focuses on the focus area when the shutter-release button is pressed halfway, the focus area display lights in green and the focus is locked.
- If the shutter-release button is pressed halfway while the focus area is not displayed, the camera focuses on the subject at the center of the frame.



**✔ Notes on Subject Tracking**

- The digital zoom is not available.
- Set the zoom position, flash mode, focus mode, or menu settings before registering a subject. If any of these are changed after a subject is registered, the subject will be canceled.
- During certain conditions, such as when the subject is moving quickly, when there is a large amount of camera shake, or when there are multiple subjects that look alike, the camera may not be able to register or track a subject, or the camera may track a different subject. Additionally, the subject may not be tracked properly depending on factors such as the subject's size and brightness.
- When the camera enters standby mode (📖23), the registration of the subject is canceled. To prevent this, setting a longer time for the auto off function (🔌73) is recommended.
- Some features cannot be used in combination with other menu settings. See "Features Not Available in Combination" (📖75) for more information.

**Autofocus Mode**

Rotate the mode dial to **P, S, A, M** or **U** → MENU button → **P, S, A, M** or **U** tab (📖10)  
→ Autofocus mode

Choose how the camera focuses.

Option	Description
<b>AF-S</b> Single AF (default setting)	The camera focuses only when the shutter-release button is pressed halfway.
<b>AF-F</b> Full-time AF	The camera focuses continuously until the shutter-release button is pressed halfway. Use with moving subjects. A sound will be heard while the camera focuses.

**✔ Note on Autofocus Mode**

Some features cannot be used in combination with other menu settings. See "Features Not Available in Combination" (📖75) for more information.

**🔧 Autofocus Mode for Movie Recording**

Autofocus mode for movie recording can be set with **Autofocus mode** (🔌51) in the movie menu.



## Flash Exp. Comp.

Rotate the mode dial to **P, S, A, M** or **U** → MENU button → **P, S, A, M** or **U** tab (📖10)  
→ Flash exp. comp.

**Flash exp. comp.** option is used to adjust the flash output.

Use this option when the flash is too bright or too dark.

Option	Description
+0.3 to +2.0	The flash output is increased from +0.3 to +2.0 EV, in increments of 1/3 EV, to make the main subject of the frame appear brighter.
0.0 (default setting)	The flash output is not adjusted.
-0.3 to -2.0	The flash output is reduced from -0.3 to -2.0 EV, in increments of 1/3 EV, to prevent unwanted highlights or reflections.

The icon for the current setting other than **0.0** is displayed on the monitor (📖12).

## Noise Reduction Filter

Rotate the mode dial to **P, S, A, M** or **U** → MENU button → **P, S, A, M** or **U** tab (📖10)  
→ Noise reduction filter

Set the strength of the noise reduction function that is normally performed when recording the picture.

Option	Description
<b>NR</b> <sup>+</sup> High	Perform noise reduction at a level higher than the standard strength.
<b>NR</b> Normal (default setting)	Perform noise reduction at the standard strength.
<b>NR</b> <sup>-</sup> Low	Perform noise reduction at a level lower than the standard strength.

Noise reduction filter setting can be confirmed on the monitor when recording a picture (📖12).

## Active D-Lighting

Rotate the mode dial to **P**, **S**, **A**, **M** or **U** → MENU button → **P**, **S**, **A**, **M** or **U** tab (📖10)  
→ Active D-Lighting

“Active D-Lighting” preserves details in highlights and shadows, creating photographs with natural contrast. The image taken reproduces the contrast effect that is seen with the naked eye. This is particularly effective for shooting scenes with high contrast, such as brightly lit outdoor scenery from a dark room or shaded subjects at a sunny seaside.

Option	Description
 High Normal Low	Set the level of the Active D-Lighting effect that is applied during shooting.
<b>OFF</b> Off (default setting)	Active D-Lighting is not applied.

The icon for the current setting other than **Off** is displayed on the monitor (📖12).

### ✓ Notes on Active D-Lighting

- Additional time is required to record images when shooting using Active D-Lighting.
- The exposure is reduced in comparison to shooting with Active D-Lighting set to **Off**. To ensure that the gradation is appropriate, adjustments of the highlighted areas, shadow areas and mid-tones are made before recording.
- Some features cannot be used in combination with other menu settings. See “Features Not Available in Combination” (📖75) for more information.

### ✓ Active D-Lighting Versus D-Lighting

The **Active D-Lighting** option in the shooting menu reduces exposure before shooting to optimize the dynamic range. The **D-Lighting** (🔍12) option in the playback menu optimizes dynamic range in pictures taken.

## Save User Settings/Reset User Settings

See “Saving Settings in **U** Mode” (📖54) for more information about Save User Settings/Reset User Settings.

## Zoom Memory

Rotate the mode dial to **P, S, A, M** or **U** → MENU button → **P, S, A, M** or **U** tab (📖10) → Zoom memory

Option	Description
On	<p>When the zoom control is operated, the camera changes in steps to the focal length (equivalent to 35mm [135] format of angle of view) of the zoom lens that is set in advance. The following settings are available: <b>24 mm, 28 mm, 35 mm, 50 mm, 85 mm, 105 mm, 135 mm, 200 mm, 300 mm, 400 mm, 500 mm, 600 mm, 800 mm</b> and <b>1000 mm</b>.</p> <ul style="list-style-type: none"> <li>• Choose the focal length with the multi selector, and then press the <b>OK</b> button to set the check box to On [✓] or Off.</li> <li>• Multiple focal lengths can be chosen.</li> <li>• The default setting is On [✓] for all the check boxes.</li> <li>• To finish the setting, press the multi selector ►.</li> <li>• The zoom position set in the <b>Startup zoom position</b> is automatically set to On [✓].</li> </ul>
Off (default setting)	<p>Even if zoom control is operated, the zoom position is not changed with each focal length.</p>

### ✓ Notes on Zoom Operation

- The changed focal length is the closest to that before the operation. To change the zoom position to the next focal length level, release the zoom control and then operate it again.
- Set **Zoom memory** to **Off** when using the digital zoom.

## Startup Zoom Position



Rotate the mode dial to **P, S, A** or **M** → MENU button → **P, S, A** or **M** tab (📖10) → Startup zoom position

When the camera is turned on, the zoom position moves to the focal length (equivalent to 35mm [135] format of angle of view) of the zoom lens that is set in advance.

The following settings are available: **24 mm** (default setting), **28 mm, 35 mm, 50 mm, 85 mm, 105 mm** and **135 mm**.

# Movie Menu

## Movie Options











Display the shooting screen → MENU button →  (Movie) tab (10) → Movie options

You can select the type of movie to record.



The camera can record normal speed movies and HS (high speed) movies (, 49), which can be played back in slow motion or fast motion.

The larger the image size and bitrate, the higher the image quality; however, the file size also becomes larger.

### Normal Speed Movies

Option <sup>1</sup>	Image size (pixels) Aspect ratio (horizontal: vertical)	Frame rate <sup>1, 2</sup> (approx.)	Movie bitrate
 1080★/30p  1080★/25p (default setting)	1920 × 1080 16:9	30 fps 25 fps	18.8 Mbps 15.7 Mbps
 1080/30p  1080/25p	1920 × 1080 16:9	30 fps 25 fps	12.6 Mbps 10.4 Mbps
 1080/60i  1080/50i	1920 × 1080 16:9	60 fps 50 fps	18.8 Mbps 15.7 Mbps
 720/30p  720/25p	1280 × 720 16:9	30 fps 25 fps	8.4 Mbps 7 Mbps
 iFrame iFrame 540/30p <sup>3</sup> iFrame 540/25p <sup>3</sup>	960 × 540 16:9	30 fps 25 fps	20.8 Mbps 17.4 Mbps
 480/30p  480/25p	640 × 480 4:3	30 fps 25 fps	2.9 Mbps 2.4 Mbps

<sup>1</sup> The items and frame rate that can be set vary depending on the settings of **Video mode** in the **TV settings** setup menu (103). Choose approximately 30 fps or 60 fps (**1080/60i**) if your TV system is **NTSC** and choose approximately 25 fps or 50 fps (**1080/50i**) if your TV system is **PAL**.

<sup>2</sup> The  **1080/60i** and  **1080/50i** settings use interlace system for recording, while other settings use progressive scanning system for recording.

<sup>3</sup> iFrame is one of the formats supported by Apple Inc. The movie editing functions (, 24) cannot be used.







## Notes on Frame rate and Bitrate

- The frame rate values indicate the number of frames per second. With a higher frame rate, the movies become more seamless but the file size also becomes larger.
- The movie bitrate is the volume of movie data recorded per second. As a variable bitrate (VBR) system has been adopted, the movie bitrate varies automatically according to the subject so that more data is recorded per second for movies containing frequently moving subjects, thus increasing movie file size.

## HS Movie

When recorded movies are played back, the camera plays back the movies in slow motion or fast motion.



See “Recording Movies in Slow Motion and Fast Motion (HS Movie)” (0051) for more information.





Option	Image size (pixels) Aspect ratio (horizontal: vertical)	Description
  HS 480/4x	640 × 480 4:3	Movies are recorded at 4x speed faster than normal speed and played back at 1/4-speed slow motion. <ul style="list-style-type: none"> <li>• Max. movie length: 7 min 15 s (playback time: 29 min)</li> </ul>
  HS 720/2x	1280 × 720 16:9	Movies are recorded at 2x speed faster than normal speed and played back at 1/2-speed slow motion. <ul style="list-style-type: none"> <li>• Max. movie length: 14 min 30 s (playback time: 29 min)</li> </ul>
  HS 1080/0.5x	1920 × 1080 16:9	Movies are recorded at 0.5x speed of normal speed and played back at 2x speed fast motion. <ul style="list-style-type: none"> <li>• Max. movie length: 29 min (playback time: 14 min 30 s)</li> </ul>

## Notes on HS Movie

- The sound is not recorded.
- Zoom position, focus, exposure and white balance are locked when movie recording starts.

## Note on HS Movie Recording and Special Effects Mode Setting

  
 HS 480/4x for **Movie options** cannot be selected when **Soft** or **Nostalgic sepia** is selected for the special effects shooting mode.













Even if you select   
 HS 480/4x for other recording mode while **Soft** or **Nostalgic sepia** is selected for the special effects shooting mode,   
 HS 720/2x is automatically selected for **Movie options** when the mode dial is rotated to **EFFECTS**.

## Maximum Movie Length

The following table lists the approximate maximum movie length that can be saved on a 4 GB memory card.

Note that the maximum movie length and file size that can be actually saved can be different depending on the image composition and subject motion even when the memory cards have the same capacity and movie options setting are the same.

Also, the maximum movie length that can be saved may differ depending on the make of the memory card.

Movie options (0048)	Maximum movie length* (4GB)
 1080★/30p	25 min
 1080★/25p	30 min
 1080/30p	40 min
 1080/25p	45 min
 1080/60i	25 min
 1080/50i	30 min
 720/30p	1 h
 720/25p	1 h 10 min
 iFrame 540/30p	25 min
 iFrame 540/25p	29 min
 480/30p	2 h 50 min
 480/25p	3 h 25 min

\* The maximum movie recording time (maximum movie length for a single movie) is 4 GB or 29 minutes, even when there is sufficient free space on the memory card. The maximum movie length for a single movie is displayed on the monitor during movie recording. If the camera becomes hot, a movie recording in progress may be terminated even if there is more time available for recording.

- Only a short movie can be recorded in the internal memory. To record a movie, use a memory card (Class 6 or higher is recommended). After removing the memory card, check the indicator showing the maximum movie length that can be stored in the internal memory (approx. 15 MB) on the screen during recording.

### More Information

See "File and Folder Names" (0090) for more information.

## Recording Movies in Slow Motion and Fast Motion (HS Movie)

When **Movie options** in the movie menu is set to HS movie (📷49), HS (high speed) movies can be recorded. Movies recorded using HS movie can be played back in slow motion at 1/4 or 1/2 of normal playback speed, or played back in fast motion at a speed two times faster than normal speed.

See “Recording Movies” (📖92) for more information on recording movies.

### When a movie is recorded at $\frac{480}{120}/\frac{480}{100}$ HS 480/4x:

Movies are recorded at a speed with a four times higher frame rate than normal speed (maximum movie length: 7 minutes and 15 seconds).

Movies are played back in slow motion that takes four times longer than normal speed.

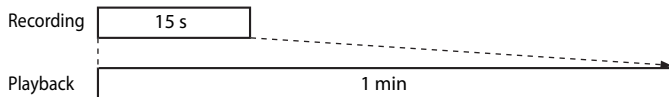

### When a movie is recorded at $\frac{1080}{15}/\frac{1080}{25}$ HS 1080/0.5x:

Movies are recorded at half (0.5x) the frame rate of normal speed (maximum movie length: 29 minutes).

Movies are played back in fast motion at a speed two times faster than normal speed.

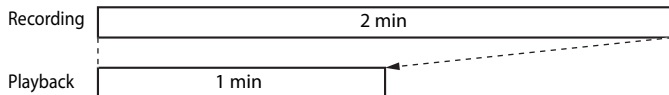

## Autofocus Mode

Display the shooting screen → MENU button → 📷 (Movie) tab (📖10) → Autofocus mode

Select how the camera focuses when recording normal speed movies (📷48).

Option	Description
AF-S Single AF (default setting)	Lock on the focus when the ● (📷 movie-record) button is pressed to start recording. Select this option when the distance between the camera and the subject remains fairly consistent.
AF-F Full-time AF	The camera focuses continuously during movie recording. Suitable for shooting when the distance between the camera and subject changes. The operation sound when the camera focuses may be recorded. Setting to <b>Single AF</b> is recommended if the sound is noticeable.

## The Playback Menu

For more information about image editing functions; (**Quick retouch**, **D-Lighting**, **Skin softening**, **Filter effects** and **Small picture**), see “Editing Still Images” (📷10).

### 🖨️ Print Order (Creating a DPOF Print Order)

Press the  button (Playback mode) → MENU button (📖10) → 🖨️ Print order





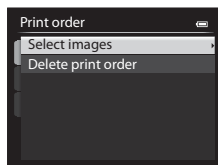

If you choose to use one of the following methods to print pictures that are stored on a memory card, the pictures to print and the number of copies can be set in advance on the memory card.

- Printing with a DPOF-compatible (🔧:22) printer that is equipped with a card slot.
- Ordering the prints to a digital photo lab that has a DPOF service.
- Printing by connecting the camera to a PictBridge-compatible (🔧:22) printer (📷19). (When the memory card is removed from the camera, the print order can also be performed for the pictures stored on the internal memory.)

#### 1 Use the multi selector to choose **Select images**, and press the button.





#### 2 Choose the pictures (up to a maximum of 99) and number of copies (up to 9 per picture).

- Rotate the multi selector or press  or  to choose the pictures, and press  or  to set the number of copies for each.
- Pictures selected for printing can be recognized by the check mark icon and the numeral indicating the number of copies to be printed. If no copies have been specified for pictures, the selection is canceled.
- Rotate the zoom control toward **T** () to switch to full-frame playback mode, or **W** () to switch to 12-thumbnail display.
- Press the  button when setting is complete.





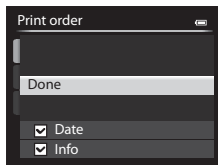

### 3 Choose whether or not to also print shooting date and shooting information.

- Choose **Date** and press the **OK** button to print the shooting date on all pictures in the print order.
- Choose **Info** and press the **OK** button to print shooting information (shutter speed and aperture value) on all pictures in the print order.
- Choose **Done** and press the **OK** button to complete the print order.
- Pictures with the print orders are recognized by the  icon displayed in playback mode (14).



### Notes on Printing Shooting Date and Shooting Information

When the **Date** and **Info** options are enabled in the print order menu, shooting date and shooting information can be printed on pictures when a DPOF-compatible () printer which supports printing of shooting date and shooting information is used.

- Shooting information cannot be printed when the camera is connected directly to a printer, via the included USB cable, for DPOF printing (.
- **Date** and **Info** are reset each time the **Print order** menu is displayed.
- The date printed on the picture is the same as those set on the camera when the picture was taken. The date printed using this option is not affected if the camera's **Time zone and date** setting is changed from the setup menu after the pictures are taken.



### Deleting All Print Orders

In step 1 of the print order procedure ()52), choose **Delete print order** and press the **OK** button to delete the print orders for all pictures.



### Print Date

The shooting date and time can be imprinted on pictures at the time of shooting by using **Print date** ()68) in the setup menu. This information can be printed even from printers that do not support printing of the date. Only the date of print date on the pictures are printed, even if **Print order** is enabled with the date selected in the print order screen.

### More Information



See "Printing Images of Size 1:1" ()74) for more information.

## Slide Show

Press the  button (Playback mode) → MENU button (10) →  Slide show



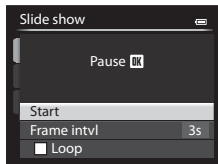

View pictures stored in the internal memory or on a memory card in an automatic slide show.

### 1 Use the multi selector to choose **Start**, and press the button.

- To change the interval between pictures, choose **Frame intvl**, and press the  button, and then select the desired interval time before choosing **Start**.
- To repeat the slide show automatically, enable **Loop** and press the  button before choosing **Start**. The check mark () is added to the loop option when enabled.





### 2 The slide show begins.

- Press the multi selector  to display the next picture, or  to display the previous picture. Press and hold  to fast forward, or  to rewind.
- To exit partway or pause, press the  button.





### 3 Choose End or Restart.



- After the last frame is played back or during playback pause, the screen shown on the right is displayed. Choose  and press the  button to return to step 1. Choose  to play the slide show again.



### Notes on Slide Shows

- Only the first frame of movies (97) included in slide shows is displayed.
- For sequences (8) whose sequence display options are set to **Key picture only**, only the key picture is displayed.
- Images captured using Easy panorama are displayed in full-frame when played in a slide show. They do not scroll.
- Slide shows play for a maximum of about 30 minutes (73).



## Protect

Press the  button (Playback mode) → MENU button (10) →  Protect

Protect selected pictures from accidental deletion.

In the image selection screen, choose a picture and set or cancel protection. See “Using the Screen for Selecting Images” (86) for more information.

Note, however, that formatting the camera’s internal memory or the memory card (74) permanently erases the protected files.



Protected pictures are recognized by the  icon in playback mode (14).

## Rotate Image

Press the  button (Playback mode) → MENU button (10) →  Rotate image

Change the orientation of pictures played back on the camera’s monitor after shooting. Still pictures can be rotated 90° clockwise or counterclockwise.

Pictures that were recorded in the “tall” orientation can be rotated up to 180° in either direction.

Select a picture in the image selection screen (86) to display the rotate image screen. Rotate the multi-selector, or press  or  to rotate the picture 90°.

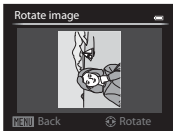

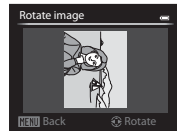
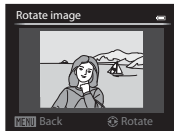

Rotated 90°  
counterclockwise





Rotated 90°  
clockwise

Press the  button to set the orientation displayed and save the orientation data with the picture.

## Notes on Image Rotation

- Images captured using 3D photography cannot be rotated.
- While only the key picture of a sequence is displayed, images cannot be rotated. Apply the setting after displaying individual images (8, 58).



### Voice Memo

Press the  button (Playback mode) → Select a picture → MENU button (10)  
→  Voice memo

Use the camera's microphone to record voice memos for pictures.



- The recording screen is displayed for a picture without voice memo, while the voice memo playback screen is displayed for a picture with voice memo (a picture marked with  in full-frame playback mode).

### Recording Voice Memos

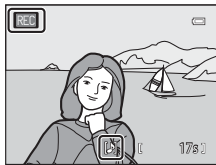
- Voice memo can be recorded for up to about 20 seconds while the  button is pressed.
- Do not touch the microphone during recording.
- During recording, **REC** and  flash on the monitor.
- When recording ends, the voice memo playback screen is displayed.





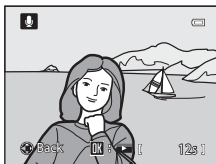

### Playing Voice Memos

- Press the  button to play back a voice memo. To end playback, press the  button again.
- Rotate the zoom control toward **T** or **W** during playback to adjust playback volume.
- Press the multi selector  before or after playing a voice memo to return to the playback menu. Press the MENU button to exit the playback menu.



### Deleting Voice Memos

Press the  button on the voice memo playback screen. Press the multi selector  or  to select **Yes** and press the  button to delete only the voice memo.

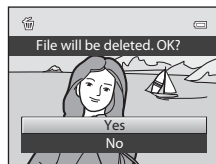



### Notes on Voice Memos

- When a picture with a voice memo attached is deleted, both the picture and its voice memo are deleted.
- Voice memos cannot be recorded for a picture that already has a voice memo attached to it. The current voice memo must be deleted before a new voice memo can be recorded.
- Voice memos cannot be attached to pictures taken with cameras other than the COOLPIX P520.
- Voice memos of the images with the **Protect** setting (55) cannot be deleted.

### More Information

See "File and Folder Names" (90) for more information.

## Copy (Copy Between Internal Memory and Memory Card)

Press the  button (Playback mode) → MENU button (10) →  Copy



Copy pictures or movies between the internal memory and a memory card.

**1** Use the multi selector to select an option from the copy screen, and press the  button.

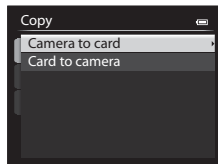
- **Camera to card:** Copy pictures from the internal memory to the memory card.
- **Card to camera:** Copy pictures from the memory card to the internal memory.







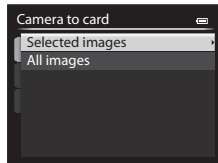

**2** Select a copy option and press the  button.

- **Selected images:** Copy pictures selected from the image selection screen (86). If a sequence for which only a key picture is displayed is selected (8), all pictures in the displayed sequence are copied.
- **All images:** Copy all pictures. If a picture in a sequence is selected, this option is not displayed.
- **Current sequence:** This option is displayed when a picture in a sequence has been selected before displaying the playback menu. All pictures in the current sequence are copied.



### Notes on Copying Pictures

- JPEG-, MOV-, WAV-, and MPO-format files can be copied. Files recorded in any other format cannot be copied.
- **Voice memo** (56) attached to pictures and **Protect** setting (55) are also copied with the pictures.
- Pictures recorded with another make or model of camera or that have been modified on a computer cannot be copied.
- **Print order** settings(52) are not copied with the pictures.
- If **Sequence display options** (58) is set to **Key picture only** and a picture in the sequence is selected and the  button is pressed to display individual pictures (8), only **Card to camera** image copy is available.

### **Message: “Memory contains no images.”**

If there are no pictures stored on the memory card when playback mode is selected, the message, **Memory contains no images.**, is displayed. Press the **MENU** button and select **Copy** from the playback menu to copy the pictures stored in the camera's internal memory to the memory card.

### **More Information**

See “File and Folder Names” (📷90) for more information.

---

## **Sequence Display Options**

Press the  button (Playback mode) → **MENU** button (📖10) →  Sequence display options



Choose the method used to display a series of pictures shot continuously (sequence, 📷8) when viewing them in full-frame playback mode (📖32) or in thumbnail playback mode (📖83).

Settings are applied to all sequences, and the setting is saved in the camera's memory even if the camera is turned off.

Option	Description
Individual pictures	Each picture in a sequence is displayed.
Key picture only (default setting)	Return a sequence in which pictures are displayed individually to the key picture only display.

---

## **Choose Key Picture**

Press the  button (Playback mode) → Select the desired sequence → **MENU** button (📖10) →  Choose key picture

When **Sequence display options** is set to **Key picture only**, the key picture displayed in full-frame playback mode (📖32) or thumbnail playback mode (📖83) can be set for each sequence of pictures.

- When changing this setting, before pressing the **MENU** button, first select the desired sequence using full-frame playback mode or thumbnail playback mode.
- When the key picture selection screen is displayed, select a picture. See “Using the Screen for Selecting Images” (📖86) for more information.

## GPS Options Menu

### GPS Options

Press the **MENU** button →  (GPS options) tab (📖10) → GPS options

Option	Description
Record GPS data	When set to <b>On</b> , signals are being received from the GPS satellites, and positioning starts (📖98). <ul style="list-style-type: none"><li>• The default setting is <b>Off</b>.</li></ul>
Update A-GPS file	A memory card is used to update the A-GPS (assist GPS) file. Using the latest A-GPS file can shorten the time needed for tracking of the position information.

### Updating the A-GPS File

Download the latest A-GPS file from the website below, and use it to update the file.

<http://nikonimglib.com/agps2/index.html>

- The A-GPS file for the COOLPIX P520 is only available from the website above.
- To update the A-GPS file, set **Record GPS data** to **Off**. When **On** is selected, the A-GPS file cannot be updated.

- 1** Download the latest A-GPS file to the computer from the website.
- 2** Use a card reader or other device to copy the downloaded file to the "NCFL" folder of the memory card.
  - The "NCFL" folder is located directly under the memory card root directory. If the memory card does not have "NCFL" folder, create a new folder.
- 3** Insert the memory card containing the copied file into the camera.
- 4** Turn on the camera.
- 5** Press the **MENU** button to display the GPS options menu, and use the multi selector to select **GPS options**.
- 6** Select **Update A-GPS file**, and update the file.
  - About 2 minutes are needed to update the A-GPS file.

## ✓ Notes on Updating A-GPS File

- The A-GPS file is disabled when a position is determined for the first time after the camera is purchased. The A-GPS file becomes active from the second operation for determining a location.
- The validity period of the A-GPS file can be checked on the update screen. If the validity period has expired, it is displayed in gray.
- Once the validity period of the A-GPS file has expired, tracking of the position information will not become faster. Updating of the A-GPS file before using the GPS feature is recommended.

## Points of Interest (POI) (Recording and Displaying Location Name Information)

Press the **MENU** button →  (GPS options) tab (📖10) → Points of interest (POI)

This shows how to set the POI (point of interest, location name information).

Option	Description
Embed POI	When set to <b>On</b> , the location name information is recorded on the pictures to be shot. <ul style="list-style-type: none"> <li>• The default setting is <b>Off</b>.</li> <li>• The location name information can be recorded on a still image or movie.</li> </ul>
Display POI	When set to <b>On</b> , the location name information is displayed on the shooting and playback screens (📖12, 14). <ul style="list-style-type: none"> <li>• If <b>Embed POI</b> was set to <b>On</b> when a picture was taken, the location name information for the picture is displayed on the playback screen.</li> <li>• The default setting is <b>Off</b>.</li> </ul>
Level of detail	Set the display level of the location name information. A higher display level shows more detailed regional information. <ul style="list-style-type: none"> <li>• When set to level 1: country names are displayed.</li> <li>• When set to levels 2 to 5: the information displayed varies depending on the country.</li> <li>• When set to level 6: landmark names (facilities) are displayed.</li> </ul>
Edit POI	If <b>Update POI</b> is selected during playback mode, the location name information recorded on the image can be changed. Select the image you want to edit, before pressing the <b>MENU</b> button. <ul style="list-style-type: none"> <li>• When level 6 is selected, press the multi selector ◀ or ▶ to change the landmark name.</li> <li>• To change the POI information level, press the multi selector ▲ or ▼.</li> </ul> If <b>Remove POI</b> is selected, the location name information recorded on the image is deleted.

## 📌 POI Display

- If there is no location name information in the display level that was set, "----" is displayed.
- The location name information (Point of Interest: POI) function is not provided for the COOLPIX P520 sold in China and the Republic of Korea.



## Create Log (Record the Log of Moving Information)

Press the **MENU** button →  (GPS options) tab (📖10) → Create log

When log recording starts, the measured moving information is recorded until a preset time has elapsed at the interval set for **Log interval**.

- It is not possible to use the log data by simply recording it. To use the data, select **End log** and save it to a memory card.

### 1 Use the multi selector to select **Start log**, and press the **OK** button.

- Before selecting **Start log**, select **Log interval** and press the **OK** button to select the intervals of log recording. The default setting is **15 s**.

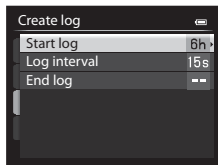

### 2 Select the duration that the log will be recorded, and press the **OK** button.

- Log recording starts.
- The log data is recorded at the interval set for the **Log interval** until the preset time is reached.
- LOG** is displayed on the screen during log recording (📖12).

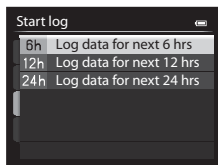

### 3 When log recording is completed, select **End log** in **Create log** in the GPS options menu, and press the **OK** button.

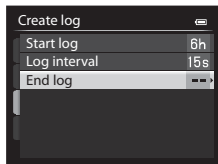

### 4 Select **Save log**, and press the **OK** button.

- The log data is saved to a memory card.

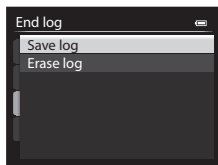

### **Notes on Log Recording**

- If the date and time are not set, the log cannot be recorded.
- Use a fully charged battery to prevent the camera from turning off during log recording. When the battery power becomes exhausted, log recording ends.
- Log recording ends due to the operations below even when there is time remaining for log recording.
  - The USB cable is connected.
  - Insert a memory card.
  - The battery is removed.
  - **Record GPS data** in **GPS options** is set to **Off** (same as when **Reset all** is performed).
  - The setting of the internal clock (time zone or date and time) is changed.
- Even when the camera is turned off, log recording is continuously performed until the preset time has elapsed if there is still time remaining for log recording.
- The log data is temporarily stored in the camera. New logs cannot be recorded if the log data remains in the camera. After recording log data, save it to a memory card.
- See “GPS Log Data Saved on Memory Cards” (0091) for more information.

### **To Erase Log Data**

- To erase the log data that is temporarily stored in the camera, select **Erase log** in step 4.
- To erase the log data that is stored on the memory card, press the  button in **View log** (0063).

## View Log

Press the **MENU** button →  (GPS options) tab (📖10) → View log

Check or erase the log data stored on the memory card using **Create log** (61).

- See “GPS Log Data Saved on Memory Cards” (91) for more information.

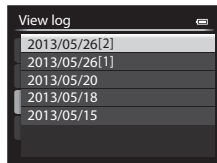

## To Erase Log Data

Press the  button to select either function.

- **Selected log**: The selected log data is erased.
- **All logs**: All log data stored on the memory card is erased.

### Log Data

Log data is NMEA format-compliant. However, display in any NMEA format-compliant software or on any NMEA format-compliant camera is not guaranteed.

## Synchronize

Press the **MENU** button →  (GPS options) tab (📖10) → Synchronize

Signals from the GPS satellites are used to set the date and time of the camera's internal clock (only when **Record GPS data** in **GPS options** of the GPS options menu is set to **On**). Check the positioning status before starting synchronize.

### Notes on Synchronize

- Date and time adjustment by **Synchronize** is set according to the time zone set in **Time zone and date** (📖24, 65) of the setup menu. Check the time zone before setting **Synchronize**.
- The date and time set using **Synchronize** is not as accurate as radio clocks. Use **Time zone and date** in the setup menu to set the time if it is not accurate in **Synchronize**.

# The Setup Menu

## Welcome Screen

Press the MENU button → Y tab (10) → Welcome screen

Select whether or not to display the welcome screen on the monitor when the camera is turned on.

Option	Description
None (default setting)	Display the shooting or playback screen without displaying the welcome screen.
COOLPIX	Display the welcome screen before displaying the shooting or playback screen.
Select an image	<p>Select a picture taken to display as the welcome screen. Display the image selection screen, choose an image (186), and press the OK button to register it.</p> <ul style="list-style-type: none"><li>• Because the selected image is stored in the camera, the image appears in the welcome screen even if the original image is deleted.</li><li>• The following pictures cannot be registered.<ul style="list-style-type: none"><li>- Pictures taken with <b>Image size</b> (173) of <b>16:9 4864×2736</b>, <b>2M 1920×1080</b>, <b>3.2M 4896×3264</b> or <b>1:1 3672×3672</b></li><li>- Pictures reduced to 320 × 240 or smaller using small picture editing (15) or crop (16)</li><li>- Pictures taken with Easy panorama</li><li>- Pictures taken using 3D photography</li></ul></li></ul>

## Time Zone and Date

Press the MENU button → Y tab (📖10) → Time zone and date

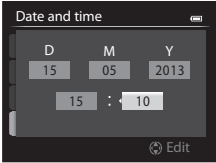
Option	Description
Date and time	<p>Set the camera clock to the current date and time. Use the multi selector to set the date and time.</p> <ul style="list-style-type: none"> <li>Choose an item: Press ► or ◀ (selected in the following order: <b>D</b> (day) → <b>M</b> (month) → <b>Y</b> (year) → <b>hour</b> → <b>minute</b>).</li> <li>Set the contents: Press ▲ or ▼. Date and time can also be set by rotating the multi selector or command dial.</li> <li>Finish setting: Choose <b>minute</b> and press the OK button or ►.</li> </ul> 
Date format	<p>Choose the order in which the day, month, and year are displayed (<b>Year/Month/Day</b>, <b>Month/Day/Year</b> or <b>Day/Month/Year</b>).</p>
Time zone	<p>🏠 Home time zone can be specified and daylight saving can be enabled or disabled. When ➡ travel destination is registered, the time difference from the 🏠 home time zone is automatically calculated and the local date and time are recorded. Useful when traveling.</p>

## Setting the Travel Destination Time Zone

**1** Use the multi selector to choose **Time zone**, and press the **OK** button.

- The **Time zone** screen is displayed.

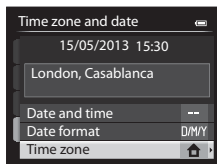

**2** Choose **Travel destination** and press the **OK** button.

- The date and time displayed on the monitor change according to the region currently selected.

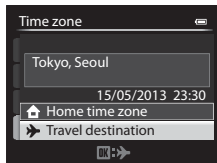

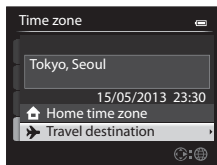

**3** Press **▶**.

- The time zone selection screen is displayed.



**4** Press **◀** or **▶** to choose the travel destination (Time zone).

- The time difference between home and the travel destination is displayed.
- In regions where daylight saving time applies, press **▲** to enable the daylight saving time function. When this function is set to on, the  icon will be displayed at the top of the monitor and the camera clock advances one hour. To disable the daylight saving time function, press **▼**.
- If the time difference cannot be selected, set the correct time using **Date and time**.
- Press the **OK** button to register the travel destination time zone.
- While the travel destination time zone is selected, the  icon is displayed on the monitor when the camera is in shooting mode.

Time difference

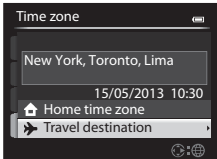
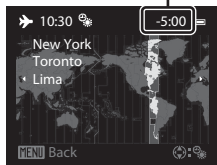

**📌** **Home Time Zone**

- To switch to the home time zone, choose **Home time zone** in step 2 and press the **OK** button.
- To change the home time zone, choose **Home time zone** in step 2 and perform the same procedure as for **Travel destination** to set the home time zone.

## Monitor Settings

Press the MENU button → Y tab (📖10) → Monitor settings

Option	Description
Image review	<b>On</b> (default setting): Picture is displayed on the monitor immediately after shooting and the monitor display returns to shooting screen. <b>Off</b> : Picture is not displayed immediately after shooting.
Brightness	Choose from 5 settings to select the monitor brightness. The default setting is <b>3</b> .
View/hide framing grid	<b>On</b> : A boxed guide for framing is displayed. <b>Off</b> (default setting): A boxed guide for framing is not displayed.
View/hide histograms	<b>On</b> : Histograms are displayed in the shooting mode even when the exposure compensation is not being set (📖13, 64). <b>Off</b> (default setting): Histograms are not displayed.

### ✔ Note on View/Hide Framing Grid

Framing grid is not displayed in the following situation.

- When the enlarged center of the picture is displayed in **MF** (manual focus)

### ✔ Notes on View/Hide Histograms

Histograms are not displayed in the following situations.

- When recording a movie
- When the enlarged center of the picture is displayed in **MF** (manual focus)
- When the flash mode, self-timer or focus mode menu is displayed

## Print Date (Imprinting Date and Time on Pictures)

Press the **MENU** button → **Y** tab (📖10) → **Print date**

The shooting date and time can be imprinted on pictures at the time of shooting. This information can be printed even from printers that do not support printing of the date (📷53).



Option	Description
<b>DATE</b> Date	The date is imprinted on pictures.
<b>DATE</b> Date and time	The date and time are imprinted on pictures.
<b>OFF</b> Off (default setting)	The date and time are not imprinted on pictures.

The icon for the current setting other than **Off** is displayed on the monitor (📖12).

### ✔ Notes on Print Date

- Imprinted date and time cannot be deleted from the image, nor can date and time be imprinted after the picture has been taken.
- Date and time cannot be imprinted in the following situations.
  - When the scene mode is set to **Easy panorama**, **Panorama assist** or **3D photography**
  - When **Pre-shooting cache**, **Continuous H: 120 fps** or **Continuous H: 60 fps** is selected for **Continuous** (📷34)
  - During movie recording
- Dates imprinted with an **Image size** (📖73) setting of **VGA 640×480** may be difficult to read. Set the image size to **1600×1200** or higher.
- The date is recorded using the format selected in the setup menu's **Time zone and date** option (📖24, 📷65).

### 📌 Print Date and Print Order



When printing from DPOF-compatible printers which support printing of shooting date and shooting information, the date and information can be printed on pictures without the date and time being imprinted on them with **Print date**, using options in the **Print order** menu (📷52).



## Vibration Reduction

Press the **MENU** button → **Y** tab (10) → Vibration reduction

Compensate camera shake. Camera shake is also compensated when recording movies as well as when shooting still images.

Option	Description
 <b>Normal</b> (default setting)	Compensate camera shake that commonly occurs when shooting at the telephoto zoom position or slow shutter speed. The camera automatically detects the panning direction and only compensates for vibration caused by camera shake. When the camera is panned horizontally, for example, vibration reduction only reduces vertical shake. If the camera is panned vertically, vibration reduction only compensates for horizontal shake.
 <b>Active</b>	Camera shake is automatically compensated during shooting if a comparatively large camera shake is likely to occur when shooting from a car or under poor foothold conditions.
<b>OFF</b> Off	Vibration reduction is not enabled.

- When using a tripod to stabilize the camera, set vibration reduction to **Off**.

The icon for the current setting other than **Off** is displayed on the monitor (12).





### Notes on Vibration Reduction

- Immediately after the power is turned on or the camera enters shooting mode from playback mode, wait until the monitor screen stabilizes before shooting.
- Due to the characteristics of the vibration reduction function, images displayed on the monitor screen immediately after shooting may appear blurry.
- Vibration reduction may be unable to completely eliminate the effects of camera shake in some situations.
- When the  (Night landscape) or **Night portrait** scene mode is set to **Tripod**, the camera shake is not compensated even if **Vibration reduction** is set to **Normal** or **Active**.

## Motion Detection

Press the **MENU** button → **Y** tab (📖10) → Motion detection

Enable motion detection to reduce the effects of camera shake and subject movement when shooting still pictures.

Option	Description
 <b>Auto</b> (default setting)	<p>If the camera detects the movement of the subject or camera shake, the ISO sensitivity is raised and the shutter speed is increased to reduce their effects. However, motion detection does not function in the following situations.</p> <ul style="list-style-type: none"> <li>• When the flash fires</li> <li>• In the following scene modes:  (Night landscape),  (Landscape),  (Backlighting), <b>Sports, Night portrait, Noise reduction burst</b> in <b>Close-up, Fireworks show, Easy panorama</b> in <b>Panorama, Pet portrait, 3D photography</b></li> <li>• When <b>EFFECTS</b> (special effects) is set to <b>High ISO monochrome</b></li> <li>• When shooting mode is <b>P, S, A, M</b> or <b>U</b></li> </ul>
<b>OFF</b> Off	Motion detection is not enabled.

When **Auto** is selected, an icon for this setting is displayed on the monitor (📖12). The motion detection icon lights in green when the camera detects any vibration and increases the shutter speed.

### Notes on Motion Detection

- Motion detection may be unable to completely reduce effects of camera shake and subject movement in some situations.
- Motion detection may not function if the subject exhibits significant movement or is too dark.
- The pictures taken may become grainy.

## AF Assist

Press the MENU button → Y tab (📖10) → AF assist

Enable or disable the AF-assist illuminator that assists the autofocus when the lighting is dim.

Option	Description
Auto (default setting)	<p>AF-assist illuminator lights automatically if the lighting is dim. The illuminator has a range of about 4.1 m (13 ft) at the maximum wide-angle position and about 2.2 m (7 ft 2 in.) at the maximum telephoto position.</p> <ul style="list-style-type: none"> <li>For some focus areas and scene modes such as <b>Museum</b> (📖42) and <b>Pet portrait</b> (📖44), AF-assist illuminator may not turn on even if <b>Auto</b> is set.</li> </ul>
Off	AF-assist illuminator does not light. The camera may be unable to focus if lighting is dim.

## Digital Zoom

Press the MENU button → Y tab (📖10) → Digital zoom

Enable or disable the digital zoom.

Option	Description
On (default setting)	When the camera is zoomed in to the maximum optical zoom position, rotating the zoom control toward T (📖) triggers the digital zoom (📖29).
Off	The digital zoom is not activated.

### 👍 Notes on Digital Zoom

- When the digital zoom is used, the focus will be at the center of the frame.
- The digital zoom cannot be used when  (Backlighting) (HDR setting is other than **Off**), **Scene auto selector**, **Portrait**, **Night portrait**, **Easy panorama** in **Panorama**, **Pet portrait** or **3D photography** is selected in scene mode.
- Some features cannot be used in combination with other menu settings. See “Features Not Available in Combination” (📖75) for more information.
- When the digital zoom is in effect, **Metering** (📖33) is set to **Center-weighted** or **Spot** depending on the magnification of an enlargement.

## Assign Side Zoom Control

Press the **MENU** button → **Y** tab (📖10) → Assign side zoom control

Choose the function to be performed during shooting when the side zoom control is used.

Option	Description
Zoom (default setting)	When shooting, use the side zoom control (📖29) to adjust the zoom.
Manual focus	When the focus mode is set to <b>MF</b> (manual focus), use the side zoom control to focus (📖2). <ul style="list-style-type: none"> <li>• Use the side zoom control in the direction of <b>T</b> to focus on distant subjects.</li> <li>• Use the side zoom control in the direction of <b>W</b> to focus on near subjects.</li> </ul>
Snap-back zoom	This is convenient when shooting at the telephoto position, when it is more difficult to keep subjects in focus. Use the side zoom control in the direction of <b>W</b> to zoom a specific increment from the current zoom position toward the <b>W</b> side. Use it in the direction of <b>W</b> again to move the zoom position further toward <b>W</b> side. Use it in the direction of <b>T</b> to return to the original zoom position, before the side zoom control was used. <ul style="list-style-type: none"> <li>• When using the digital zoom, use the side zoom control in the direction of <b>W</b> to move to the telephoto end of the optical zoom.</li> <li>• If you perform any operation other than the side zoom control, the zoom is not returned to the zoom position before the operation.</li> <li>• <b>Snap-back zoom</b> is not available during movie recording.</li> </ul>

## Sound Settings

Press the **MENU** button → **Y** tab (📖10) → Sound settings

Adjust the following sound settings.

Option	Description
Button sound	Set the following all sound settings to <b>On</b> (default setting) or <b>Off</b> . <ul style="list-style-type: none"> <li>• Setting beep (beep sounds once when the settings are completed)</li> <li>• Focus beep (beep sounds twice when the camera focuses on the subject)</li> <li>• Error beep (beep sounds three times when an error is detected)</li> <li>• Start-up sounds to be emitted when the camera is turned on. (No sound is emitted when <b>Welcome screen</b> is set to <b>None</b>.)</li> </ul>
Shutter sound	Choose whether to set the shutter sound to <b>On</b> (default setting) or <b>Off</b> .

### ✔ Notes on Sound Settings

- In **Pet portrait** scene mode, even when **On** is set, the button sound and shutter sound are disabled.
- Even when **On** is set, the shutter sound is disabled during movie recording.
- Some features cannot be used in combination with other menu settings. See “Features Not Available in Combination” (📖75) for more information.

## Auto Off

Press the **MENU** button → **Y** tab (📖10) → Auto off

If no operations are performed for a certain period while the camera is on, the monitor is turned off to save power and the camera enters standby mode (📖23). In this menu, set the time before the camera enters standby mode. Choose from **30 s**, **1 min** (default setting), **5 min** and **30 min**.

### 📎 Auto Off Setting

- In the following situations, the time taken for the camera to enter standby mode is fixed.
  - When menus are displayed: 3 minutes (when auto off is set to **30 s** or **1 min**.)
  - During slideshow playback: maximum of 30 minutes
  - When the AC Adapter EH-62A is connected: 30 minutes
- The camera does not enter standby mode when transferring images using the Eye-Fi card.

## Format Memory/Format Card

Press the MENU button → Y tab (📖10) → Format memory/Format card

Format the internal memory or a memory card.

**Formatting permanently deletes all data in the internal memory or memory card.** The deleted data cannot be recovered. Be sure to transfer important pictures to a computer before formatting.

### Formatting the Internal Memory

To format the internal memory, remove the memory card from the camera. The **Format memory** option is displayed on the setup menu.

### Formatting Memory Cards

When a memory card is inserted in the camera, the memory card can be formatted. The **Format card** option is displayed on the setup menu.

#### Formatting Internal Memory and Memory card

- Do not turn off the camera or open the battery-chamber/memory card slot cover during formatting.
- The first time you insert a memory card that has been used in another device into this camera, be sure to format it with this camera.

## Language

Press the MENU button → Y tab (📖10) → Language

Choose one of 34 languages for displaying the camera menus and messages.

Čeština	Czech
Dansk	Danish
Deutsch	German
English	(default setting)
Español	Spanish
Ελληνικά	Greek
Français	French
Indonesia	Indonesian
Italiano	Italian
Magyar	Hungarian
Nederlands	Dutch

Norsk	Norwegian
Polski	Polish
Português (BR)	Brazilian Portuguese
Português (PT)	Portuguese
Русский	Russian
Română	Romanian
Suomi	Finnish
Svenska	Swedish
Tiếng Việt	Vietnamese
Türkçe	Turkish
Українська	Ukrainian

عربي	Arabic
বাংলা	Bengali
简体中文	Simplified Chinese
繁體中文	Traditional Chinese
हिन्दी	Hindi
日本語	Japanese
한글	Korean
मराठी	Marathi
فارسی	Persian
தமிழ்	Tamil
తెలుగు	Telugu
ภาษาไทย	Thai

## TV Settings

Press the **MENU** button → **Y** tab (📖10) → TV settings

Adjust the settings for connecting to a TV.

Option	Description
Video mode	Select the analog video output system from <b>NTSC</b> or <b>PAL</b> in accordance with your TV. <ul style="list-style-type: none"> <li>The available frame rates in <b>Movie options</b> (🎞️48) change depending on the setting of the video mode.</li> </ul>
HDMI	Select a picture resolution for HDMI output from <b>Auto</b> (default setting), <b>480p</b> , <b>720p</b> or <b>1080i</b> . When <b>Auto</b> is set, the output resolution that is best suited to the connected TV is selected automatically from <b>480p</b> , <b>720p</b> or <b>1080i</b> .
HDMI device control	Select whether or not the camera receives signals from a TV when a TV that conforms to the HDMI-CEC standard is connected with an HDMI cable. When set to <b>On</b> (default setting), the television remote control can be used to operate the camera during playback. See "Using the TV's Remote Control (HDMI Device Control)" (🎮18) for more information.
HDMI 3D output	Set the method used to output 3D images to HDMI devices. Select <b>On</b> (default setting) to three-dimensionally play back 3D images taken with this camera on a TV or monitor that is connected via HDMI.

## Charge by Computer

Press the MENU button → Y tab (📖10) → Charge by computer

Select whether or not the battery inserted into the camera is charged when the camera is connected to a computer via the USB cable (📖87).

Option	Description
Auto (default setting)	When the camera is connected to a computer that is running, the battery inserted into the camera is automatically charged using power supplied by the computer.
Off	The battery inserted into the camera is not charged when the camera is connected to a computer.

### ✔ Notes on Connecting the Camera to a Printer

- The battery cannot be charged with connection to a printer, even if the printer complies with the PictBridge standard.
- When **Auto** is selected for **Charge by computer**, it may be impossible to print images with direct connection of the camera to some printers. If the PictBridge startup screen is not displayed on the monitor after the camera is connected to a printer and turned on, turn the camera off and disconnect the USB cable. Set **Charge by computer** to **Off** and reconnect the camera to the printer.

### ✔ Notes on Charging with Connection to a Computer

- The battery cannot be charged, nor can data be transferred, when the camera is connected to a computer before the camera's display language and date and time have been set (📖24). If the camera's clock battery (📖25) has been exhausted, the date and time must be reset before the battery can be charged or images can be transferred with connection to a computer. In this case, use the Charging AC Adapter EH-69P (📖18) to charge the battery and then set the camera's date and time.
- If the camera is turned off, charging will also stop.
- If the computer enters sleep mode while charging, charging will stop and the camera may be turned off.
- When disconnecting the camera from the computer, turn the camera off and then disconnect the USB cable.
- It may take longer to charge the battery with connection to a computer than with charging using the Charging AC Adapter EH-69P. Charging time increases when images are transferred while the battery is charging.
- When the camera is connected to a computer, an application installed on the computer, such as Nikon Transfer 2, may start. If the camera was connected to the computer for the sole purpose of charging the battery, exit the application.
- The camera turns off automatically if there is no communication with the computer for 30 minutes after the battery has finished charging.
- Depending upon computer specifications, settings, and power supply and allocation, it may be impossible to charge the battery using a computer connection while it is inserted into the camera.



## The Charge Lamp

The following chart explains charge lamp status when the camera is connected to a computer.

Option	Description
Flashes slowly (green)	Battery charging.
Off	Battery not charging. If the charge lamp changes from slow flashing (green) to off while the power-on lamp is lit, charging is complete.
Flashes quickly (green)	<ul style="list-style-type: none"> <li>• The ambient temperature is not suited to charging. Charge the battery indoors with an ambient temperature of 5°C to 35°C (41°F to 95°F).</li> <li>• The USB cable is not connected correctly, or the battery is faulty. Make sure the USB cable is connected correctly and replace the battery if necessary.</li> <li>• The computer is in sleep mode and is not supplying power. Wake up the computer.</li> <li>• The battery cannot be charged because the computer cannot supply power to the camera, due to the computer's settings or its specifications.</li> </ul>

## Toggle Av/Tv Selection

Press the MENU button → Y tab (📖10) → Toggle Av/Tv selection

Switch the method for setting the flexible program, shutter speed or aperture value.

- This feature can be used when shooting mode is set to **P, S, A, M** or **U**.

Option	Description
Do not toggle selection (default setting)	Use the command dial to set the flexible program or shutter speed, and the multi selector to set the aperture value.
Toggle selection	Use the multi selector to set the flexible program or shutter speed, and the command dial to set the aperture value.

## Reset File Numbering

Press the MENU button → Y tab (📖10) → Reset file numbering

When **Yes** is selected, the sequential numbering of file numbers is reset (🔍90). After resetting, a new folder is created and the file number for the next picture taken starts from "0001."

### Note on Reset File Numbering

**Reset file numbering** cannot be applied when the folder number reaches 999 and there are images in the folder. Insert a new memory card, or format the internal memory/memory card (🔍74).

## Blink Warning

Press the **MENU** button → **Y** tab (📖10) → Blink warning

Choose whether or not blinking eyes are detected when using face detection (📖80) in the following shooting modes.

- In the following scene modes: **Scene auto selector** (📖39), **Portrait** (📖39) or **Night portrait** (when **Tripod** is selected) (📖40)
- Shooting modes **P, S, A, M, U** (when **Face priority** (📖40) is selected for **AF area mode**)

Option	Description
On	The <b>Did someone blink?</b> screen is displayed on the monitor if the camera detects that a human subject may have closed the eyes immediately after taking a picture using face detection. The face of the human subject that may have closed his/her eyes is framed by a yellow border. You can check the picture taken and determine if you need to take the picture again.
Off (default setting)	The camera does not detect blinks.

### The Did someone blink? Screen

- To zoom in the face for which blinking was detected, rotate the zoom control toward **T** (📷). To return to full-frame playback mode, rotate the zoom control toward **W** (📷).
- When the camera detects that one or more human subjects have closed their eyes, press ◀ or ▶ during playback zoom to display other faces.
- Press the 🗑️ button to delete the picture taken.
- Press the Ⓞ button or the shutter-release button to return to shooting mode.
- If no operations are performed for a few seconds, the screen automatically returns to the shooting screen.





### ✔ Note on Blink Warning

Some features cannot be used in combination with other menu settings. See "Features Not Available in Combination" (📖75) for more information.

## Eye-Fi Upload

Press the MENU button → Y tab (10) → Eye-Fi upload





Option	Description
 <b>Enable (default setting)</b>	Upload images created by the camera to a preselected destination when an Eye-Fi card is in the camera.
 <b>Disable</b>	Images will not be uploaded.

### Notes on Eye-Fi Cards

- Note that images will not be uploaded if signal strength is insufficient even if **Enable** is selected.
- Remove the Eye-Fi card from the camera in a place where the use of radio waves is prohibited. Signals may be transmitted even if **Disable** is selected.
- Refer to the instruction manual of your Eye-Fi card for more information. In the event of malfunction, contact the card manufacturer.
- The camera can be used to turn Eye-Fi cards on and off, but may not support other Eye-Fi functions.
- The camera is not compatible with the endless memory function. When it is set on a computer, disable the function. If the endless memory function is enabled, the number of pictures taken may not be displayed correctly.
- Eye-Fi cards are for use only in the country of purchase. Observe all local laws concerning wireless devices.
- Leaving the setting as **Enable** will result in the battery being depleted in a shorter period of time.

### Eye-Fi Communication Indicator

The communication status of the Eye-Fi card in the camera can be confirmed on the monitor (12).

- : **Eye-Fi upload** is set to **Disable**.
-  (lights): Eye-Fi upload enabled; waiting to begin upload.
-  (flashes): Eye-Fi upload enabled; uploading data.
- : An error occurred. The camera cannot control the Eye-Fi card.

## Reverse Indicators

Press the MENU button → Y tab (10) → Reverse indicators

Change the +/- display direction of the exposure indicator (51) displayed when shooting mode is **M**.

The + side of the indicator is up and - side is down in the default setting.

## Reset All

Press the MENU button → Y tab (📖10) → Reset all

When **Reset** is selected, the camera settings are restored to the default values.

### Pop-up Menu

Option	Default value
Flash mode (📖56)	Auto
Self-timer (📖59)/ Smile timer (📖60)	OFF
Focus mode (📖62)	Autofocus
Exposure compensation (📖64)	0.0

### Shooting in the Scene Mode

Option	Default value
Scene menu (📖36)	Scene auto selector
Night portrait (📖40)	Tripod
Close-up (📖41)	Single shot
Hue adjustment in Food mode (📖42)	Center
Panorama (📖43)	Normal (180°) in Easy panorama
Pet portrait (📖44)	Pet portrait auto release: ON Continuous: Continuous

### Night Landscape Menu

Option	Default value
Night landscape (📖37)	Hand-held

### Landscape Menu

Option	Default value
Landscape (📖38)	Single shot

### Backlighting Menu

Option	Default value
HDR (📖38)	Off



### Special Effects Menu

Option	Default value
Special effects (📖47)	Soft

## Shooting Menu

Option	Default value
Image quality (📖72)	Normal
Image size (📖73)	 4896x3672
Picture Control (🔍26)	Standard
White balance (🔍31)	Auto (normal)
Fine adjustment in white balance (🔍31)	0
Metering (🔍33)	Matrix
Continuous (🔍34)	Single
Intvl timer shooting (🔍36)	30 s
ISO sensitivity (🔍38)	Auto
Minimum shutter speed (🔍38)	None
Exposure bracketing (🔍39)	Off
AF area mode (🔍40)	Auto
Autofocus mode (🔍44)	Single AF
Flash exp. comp. (🔍45)	0.0
Noise reduction filter (🔍45)	Normal
Active D-Lighting (🔍46)	Off
Zoom memory (🔍47)	Off
Startup zoom position (🔍47)	24 mm

## Movie Menu

Option	Default value
Movie options (🔍48)	 1080★/30p or  1080★/25p
Autofocus mode (🔍51)	Single AF

## GPS Options Menu

Option	Default value
Record GPS data (🔍59)	Off
Embed POI (🔍60)	Off
Display POI (🔍60)	Off
Level of detail (🔍60)	Level 6 (detailed)
Log interval (🔍61)	15 s
Log recording duration (🔍61)	Log data for next 6 hrs

## Setup Menu

Option	Default value
Welcome screen (🔗64)	None
Image review (🔗67)	On
Brightness (🔗67)	3
View/hide framing grid (🔗67)	Off
View/hide histograms (🔗67)	Off
Print date (🔗68)	Off
Vibration reduction (🔗69)	Normal
Motion detection (🔗70)	Off
AF assist (🔗71)	Auto
Digital zoom (🔗71)	On
Assign side zoom control (🔗72)	Zoom
Button sound (🔗73)	On
Shutter sound (🔗73)	On
Auto off (🔗73)	1 min
HDMI (🔗75)	Auto
HDMI device control (🔗75)	On
HDMI 3D output (🔗75)	On
Charge by computer (🔗76)	Auto
Toggle Av/Tv selection (🔗78)	Do not toggle selection
Blink warning (🔗79)	Off
Eye-Fi upload (🔗80)	Enable
Reverse indicators (🔗80)	+0-

## Function Menu

Option	Default value
Fn button (📖71)	Continuous

## Others

Option	Default value
Paper size (🔗20, 🔗21)	Default
Frame intvl for Slide show (🔗54)	3 s
Sequence display options (🔗58)	Key picture only

## The Setup Menu

- Choosing **Reset all** also clears the current file number (📷90) in the memory. After resetting, numbering continues from the lowest number available in the internal memory or the memory card. If **Reset all** is performed after all pictures are deleted from the internal memory or memory card (📖33), the file numbers for the next pictures taken start from "0001."
- The following settings remain unaffected even if **Reset all** is performed.  
**Shooting menu: Custom Picture Control** registration (📷30) and preset manual data for **White balance** (📷32)  
**Setup menu: Time zone and date** (📷65), **Language** (📷74) and **Video mode** (📷75) in **TV settings**
- User settings that were saved for mode dial **U** are not reset to the default settings when **Reset all** is performed. To change these settings back to the default settings, use **Reset user settings** (📷46).

---

## Firmware Version

Press the MENU button → Y tab (📖10) → Firmware version



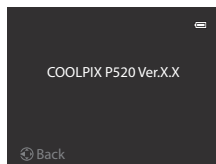

Displays the current camera firmware version.

















## Error Messages

The following table lists the error messages and other warnings displayed on the monitor, as well as the solutions for dealing with them.



Display	Cause/Solution	
 (flashes)	Clock not set. Set date and time.	 65
Battery exhausted.	Battery exhausted. Charge or replace the battery.	16, 18
Battery temperature is elevated. The camera will turn off.	Battery temperature is high. Turn off camera, and allow battery to cool down before resuming use. Five seconds after this message appears, the monitor is turned off, and the power-on lamp starts flashing quickly. After the lamps flash for three minutes, the camera turns off automatically, but you can also press the power switch to turn it off manually.	23
The camera will turn off to prevent overheating.	Inside of the camera has become hot. The camera turns off automatically. Leave the camera off until the inside of the camera has cooled and then turn it on again.	—
 (flashes red)	Camera cannot focus. <ul style="list-style-type: none"> <li>• Refocus.</li> <li>• Use focus lock.</li> </ul>	30 81
Please wait for the camera to finish recording.	Camera cannot perform other operations until recording is complete. Wait until message clears from display automatically when recording is complete.	—
Memory card is write protected.	Write-protect switch of the memory card is in "lock" position. Slide the write-protect switch to "write" position.	—
Not available if Eye-Fi card is locked.	Write-protect switch of Eye-Fi card is in "lock" position. Slide the write-protect switch to "write" position.	—
	Error accessing Eye-Fi card. <ul style="list-style-type: none"> <li>• Check that the terminal is clean.</li> <li>• Confirm that memory card is correctly inserted.</li> </ul>	20 20
This card cannot be used.	Error accessing memory card. <ul style="list-style-type: none"> <li>• Use an approved card.</li> <li>• Check that the terminal is clean.</li> <li>• Confirm that memory card is correctly inserted.</li> </ul>	21 20 20
This card cannot be read.		
Card is not formatted. Format card? Yes No	Memory card has not been formatted for use in this camera. All data stored on the memory card is deleted when formatted. If there is any data on the card that you want to keep, select <b>No</b> , and backup the data to a computer before formatting the memory card. To format the memory card, select <b>Yes</b> and press the  button.	20









## Error Messages

Display	Cause/Solution	
Out of memory.	Memory card is full. <ul style="list-style-type: none"> <li>Choose lower image quality or smaller image size.</li> <li>Delete pictures and movies.</li> <li>Replace memory card.</li> <li>Remove memory card and use internal memory.</li> </ul>	72, 73 33, 97 20 21
Image cannot be saved.	Error occurred while recording picture. Format the internal memory or memory card.	 74
	Camera has run out of file numbers. Replace the memory card, or format the internal memory/memory card.	20,  74
	Picture cannot be used for welcome screen.	 64
	There is insufficient space to save a copy. Delete pictures from destination.	33
Unable to create panorama.	Cannot perform Easy panorama shooting. Easy panorama shooting may not be available in the following situations. <ul style="list-style-type: none"> <li>When shooting has not finished after a certain period of time</li> <li>When the camera movement speed is too fast</li> <li>When the camera is not straight relative to the panorama direction</li> </ul>	 3
Unable to create panorama. Pan the camera in one direction only.		
Unable to create panorama. Pan the camera more slowly.		
Shooting failed	Failed to shoot the first image for 3D photography. <ul style="list-style-type: none"> <li>Try shooting again.</li> <li>In some shooting conditions, such as when the subject moves or the subject is dark or low in contrast, the picture may not be taken.</li> </ul>	45 –
Failed to take second shot	When taking 3D images, the second shot could not be successfully taken after the first shot. <ul style="list-style-type: none"> <li>Try shooting again. After taking the first shot, move the camera horizontally and frame the subject so that it is aligned with the guide.</li> <li>In some shooting conditions, such as when the subject moves or the subject is dark or low in contrast, the second shot may not be taken.</li> </ul>	45 –
Failed to save 3D image	Failed to save the 3D images. <ul style="list-style-type: none"> <li>Try shooting again.</li> <li>Delete unnecessary pictures.</li> <li>In some shooting conditions, such as when the subject moves or the subject is dark or low in contrast, the 3D images may not be created, resulting in failure to save them.</li> </ul>	45 33 –
Sound file cannot be saved.	A voice memo cannot be attached to this file. <ul style="list-style-type: none"> <li>Voice memos cannot be attached to movies.</li> <li>Select a picture taken with this camera.</li> </ul>	–  56

Display	Cause/Solution	
Image cannot be modified.	Cannot edit selected picture. <ul style="list-style-type: none"> <li>Confirm the conditions that are required for editing.</li> <li>These options cannot be used with movies.</li> </ul>	 11 –
Cannot record movie.	Time out error while recording movie. Choose a memory card with a faster write speed.	21
Cannot reset file numbering.	No more folders can be created. Insert a new memory card, or format the internal memory/ memory card.	20,  74
Memory contains no images.	No pictures in the internal memory or memory card. <ul style="list-style-type: none"> <li>To view the pictures stored in the internal memory, remove the memory card.</li> <li>To copy pictures from internal memory to a memory card, press the <b>MENU</b> button and select <b>Copy</b> from the playback menu.</li> </ul>	20   57
File contains no image data.	File not created with the COOLPIX P520. File cannot be viewed on this camera.	–
This file cannot be played back.	View file using the computer or any other devices which was used to create or edit this file.	–
All images are hidden.	No images available for a slide show.	–
This image cannot be deleted.	Picture is protected. Disable protection.	 55
Travel destination is in the current time zone.	Destination in same time zone as home.	–
Mode dial is not in the proper position.	Mode dial is between two modes. Rotate the mode dial to select the desired mode.	26
Raise the flash.	<ul style="list-style-type: none"> <li>When the scene mode is <b>Scene auto selector</b>, you can take a picture even if the flash is lowered but the flash will not fire.</li> <li>When the scene mode is <b>Night portrait</b> or  (Backlighting) with <b>HDR</b> set to <b>Off</b>, you must raise the flash to take a picture.</li> </ul>	39 38, 40
Lens error	Lens error occurred. Turn the camera off and then on again. If the error persists, contact retailer or Nikon-authorized service representative.	23
Communications error	Error occurred during communication with printer. Turn off camera and reconnect the USB cable.	 19
System error	Error has occurred in camera's internal circuitry. Turn off camera, remove and reinsert battery, and turn on camera. If the error persists, contact retailer or Nikon-authorized service representative.	23
Could not obtain GPS data.	The camera clock is not set correctly. Change the location or time and determine the location again.	–

## Error Messages

Display	Cause/Solution	
No A-GPS file found on card	An A-GPS file that can be updated is not found on the memory card. Check the following items. <ul style="list-style-type: none"> <li>• Whether the memory card is inserted</li> <li>• Whether the A-GPS file is stored on the memory card</li> <li>• Whether the A-GPS file saved on the memory card is more recent than the A-GPS file saved in the camera</li> <li>• Whether the A-GPS file is still valid</li> </ul>	-
Update failed	Unable to update A-GPS file. The A-GPS file may be corrupted. Download the file from the website once more.	 59
Cannot save to card	A memory card is not inserted. Insert a memory card.	20
	100 log data events have already been saved or 36 log data events have been saved for one day. Delete log data that is no longer required from a memory card or replace the memory card with a new one.	 63

Display	Cause/Solution	
Printer error: check printer status.	Printer error. Check printer. After solving the problem, select <b>Resume</b> and press the  button to resume printing.*	–
Printer error: check paper	Specified size of paper is not loaded. Load the specified size of paper, select <b>Resume</b> and press the  button to resume printing.*	–
Printer error: paper jam	Paper has jammed in the printer. Remove the jammed paper, select <b>Resume</b> and press the  button to resume printing.*	–
Printer error: out of paper	No paper is loaded in the printer. Load the specified size of paper, select <b>Resume</b> and press the  button to resume printing.*	–
Printer error: check ink	Ink error. Check ink, select <b>Resume</b> and press the  button to resume printing.*	–
Printer error: out of ink	Ink cartridge is empty. Replace ink cartridge, select <b>Resume</b> and press the  button to resume printing.*	–
Printer error: file corrupt	An error caused by the image file has occurred. Select <b>Cancel</b> and press the  button to cancel printing.	–

\* See the instruction manual provided with your printer for further guidance and information.

## File and Folder Names

Pictures, movies and voice memos are assigned file names as follows.

### File name : DSCN0001.JPG

(1) (2) (3)

(1) Identifier	Not displayed on camera monitor.	
	DSCN	Original still pictures, movies, still pictures extracted from movies
	SSCN	Small copies
	RSCN	Cropped copies
	FSCN	Pictures created with picture editing other than crop and small picture, movies created with movie editing
(2) File number	Assigned automatically in ascending order, starting from "0001" to "9999." <ul style="list-style-type: none"><li>• When the file numbers in a folder reach "9999," a new folder is created and the next file number returns to "0001."</li><li>• Serial file numbers are automatically assigned to still pictures that are saved during movie recording (📖95), starting from the "file number of the movie currently being recorded + 1."</li></ul>	
(3) Extension	Signifies the file type.	
	.JPG	JPEG still pictures
	.MOV	Movies
	.WAV	Voice memos <ul style="list-style-type: none"><li>• Identifier and file number are the same as the picture to which the voice memo is attached.</li></ul>
	.MPO	3D images

**Folder name : 100NIKON**

(1) (2)

(1) Folder number	Assigned automatically in ascending order, starting from "100" to "999." <ul style="list-style-type: none"> <li>• A new folder is created under the following conditions.             <ul style="list-style-type: none"> <li>- When the number of files in a folder reaches 200</li> <li>- When the file numbers in a folder reach 9999</li> <li>- When <b>Reset file numbering</b> (8878) is performed</li> </ul> </li> <li>• If a folder is empty, a new folder is not created even if <b>Reset file numbering</b> is performed.</li> </ul>	
(2) Folder name	NIKON	Still pictures and movies other than those taken using panorama assist or interval timer shooting
	P_001	Pictures taken using panorama assist <ul style="list-style-type: none"> <li>• A new folder is created each time a picture is taken.</li> <li>• The pictures are sequentially saved in file numbers starting from 0001.</li> </ul>
	INTVL	Pictures taken using interval timer shooting <ul style="list-style-type: none"> <li>• A new folder is created each time a picture is taken.</li> <li>• The pictures are sequentially saved in file numbers starting from 0001.</li> </ul>

**Notes**

- When image files or voice files are copied to or from the internal memory or memory card (8857), the file naming conventions are as follows:
  - Selected images:  
Files copied using selected images are copied to the current folder (or to the folder used for subsequent pictures), where they are assigned file numbers in ascending order following the largest file number in memory.
  - All images:  
Files copied using all images, along with their folder, are copied together. Folder numbers are assigned in ascending order, following the largest folder number on the destination medium. File names are not changed.
- When the current folder is numbered 999, if there are 200 files in the folder or if a file is numbered 9999, no further pictures can be shot until the internal memory or memory card is formatted (8874), or a new memory card is inserted.

**GPS Log Data Saved on Memory Cards**

- The log data is saved in the "NCFL" folder.  
The file names consist of "N", "date (the last two digits of the year, month, and date)", "identification number (0 to 9 and A to Z)" and "extension (.log)."  
Example: the first GPS log recorded on 15 May 2013 is  
N1305150.log
- Up to 36 files can be recorded a day and up to 100 files can be recorded on a memory card.

## Optional Accessories

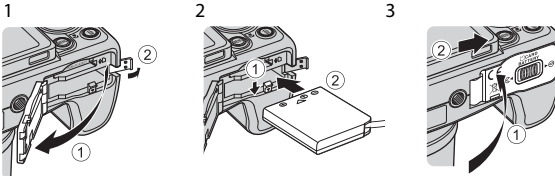
Battery charger	Battery Charger MH-61 (Charging time when the battery is completely used up: Approx. 2 hours)
AC adapter	AC Adapter EH-62A (connect as shown)  Before closing the battery-chamber/memory card slot cover, fully insert the power connector cord into the slot in the battery chamber. If part of the cord runs out of the groove, the cover or cord may be damaged when the cover is closed.
Hand strap	Hand Strap AH-CP1
Wireless Mobile Adapter	Wireless Mobile Adapter WU-1a When you attach the WU-1a to the USB/Audio video connector (1), the camera can connect via Wi-Fi (wireless LAN) connection to smart devices that have the dedicated software installed. You can use your smart device to release the camera's shutter by remote operation or copy images stored on the memory card inserted in the camera to the smart device. <ul style="list-style-type: none"><li>• Operations other than turning on and off the camera using the camera's controls cannot be performed during remote control operation.</li><li>• This function cannot be used when the Eye-Fi card is inserted into the camera.</li></ul> See our websites, product catalogs, or the instruction manual of the WU-1a for further details.

See our websites or product catalogs for up-to-date information on accessories for the COOLPIX P520.





# Technical Notes and Index

<b>Caring for the Products .....</b>	<b>2</b>
The Camera.....	2
The Battery.....	3
Charging AC Adapter.....	4
The Memory Cards.....	5
<b>Caring for the Camera .....</b>	<b>6</b>
Cleaning.....	6
Storage.....	6
<b>Troubleshooting .....</b>	<b>7</b>
<b>USER LICENSE AGREEMENT FOR LOCATION</b>	
<b>NAME DATA .....</b>	<b>15</b>
<b>Specifications.....</b>	<b>19</b>
Supported Standards.....	22
<b>Index .....</b>	<b>24</b>

## Caring for the Products

### The Camera

To ensure continued enjoyment of this Nikon product, observe the following precautions when using or storing the device.

Be sure to read and follow the warnings of “For Your Safety” (📖 vi to viii) thoroughly before using the products.

#### ✔ **Keep Dry**

The device will be damaged if immersed in water or subjected to high humidity.

#### ✔ **Do Not Drop**

The product may malfunction if subjected to strong shock or vibration.

#### ✔ **Handle the Lens and All Moving Parts with Care**

Do not apply force to the lens, lens cover, monitor, memory card slot, or battery chamber. These parts are easily damaged. Applying force to the lens cover could result in camera malfunction or damage to the lens. Should the monitor break, care should be taken to avoid injury caused by broken glass and to prevent the liquid crystal from the display touching the skin or entering the eyes or mouth.

#### ✔ **Do Not Point the Lens at Strong Light Sources for Extended Periods**

Avoid pointing the lens at the sun or other strong light sources for extended periods when using or storing the camera. Intense light may cause deterioration of the image sensor, producing a white blur effect in photographs.

#### ✔ **Keep away from Strong Magnetic Fields**

Do not use or store this device in the vicinity of equipment that generates strong electromagnetic radiation or magnetic fields. Strong static charge or the magnetic fields produced by equipment such as radio transmitters could interfere with the monitor, damage data saved on the memory card, or affect the product's internal circuitry.

#### ✔ **Avoid Sudden Changes in Temperature**

Sudden changes in temperature, such as when entering or leaving a heated building on a cold day, can cause condensation to form inside the device. To prevent condensation, place the device in a carrying case or a plastic bag before exposing it to sudden changes in temperature.

#### ✔ **Turn the Product off Before Removing or Disconnecting the Power Source or the Memory Card**

Do not remove the battery while the product is on, or while images are being saved or deleted. Forcibly cutting power in these circumstances could result in loss of data or in damage to product memory or internal circuitry.

## Notes on the Monitor

- Monitors and electronic viewfinders are constructed with extremely high precision; at least 99.99% of pixels are effective, with no more than 0.01% being missing or defective. Hence while these displays may contain pixels that are always lit (white, red, blue, or green) or always off (black), this is not a malfunction and has no effect on images recorded with the device.
- Images on the monitor may be difficult to see under bright lighting.
- The monitor is lit by an LED backlight. Should the monitor begin to dim or flicker, contact your Nikon-authorized service representative.

## The Battery

- Be sure to read and follow the warnings of “For Your Safety” ( vi to viii) thoroughly before using the battery.
- Check the battery level before using the camera and replace or charge the battery if necessary. Do not continue charging once the battery is fully charged as this will result in reduced battery performance. Whenever possible, carry a fully charged spare battery when taking pictures on important occasions.
- Do not use the battery at ambient temperatures below 0°C (32°F) or above 40°C (104°F).
- Charge the battery indoors with an ambient temperature of 5°C to 35°C (41°F to 95°F) before use.
- When the battery temperature is between 45°C to 60°C (113°F to 140°F), the chargeable capacity may decrease.
- The battery is not charged at ambient temperatures below 0°C (32°F) or above 60°C (140°F).
- Note that the battery may become hot during use; wait for the battery to cool before charging. Failure to observe these precautions could damage the battery, impair its performance, or prevent it from charging normally.
- On cold days, the capacity of batteries tends to decrease. Be sure that the battery is fully charged before heading outside to take pictures in cold weather. Keep spare batteries in a warm place and exchange as necessary. Once warmed, a cold battery may recover some of its charge.
- Dirt on the battery terminals can prevent the camera from functioning. Should the battery terminals become dirty, wipe them off with a clean, dry cloth before use.

## Caring for the Products

- If the battery will not be used for some time, insert it in the camera and run it flat before removing it for storage. The battery should be stored in a cool location with an ambient temperature of 15°C to 25°C (59°F to 77°F). Do not store the battery in hot or extremely cold locations.
- Always remove the battery from the camera or battery charger when it is not being used. When inserted, minute amounts of current are drawn from the battery even when not in use. This may result in excessive draining of the battery and complete loss of function. Turning the camera on or off while the battery is exhausted can result in reduced battery life. When the battery level is low, be sure to charge the battery before using it.
- Recharge the battery at least once every six months and completely exhaust it before returning it to storage.
- After removing the battery from the camera or battery charger, attach the included terminal cover to the battery and store it in a cool place.
- A marked drop in the time a fully-charged battery retains its charge, when used at room temperature, indicates that the battery needs to be replaced. Purchase a new EN-EL5 battery.
- Replace the battery when it no longer holds a charge. Used batteries are a valuable resource. Please recycle used batteries in accordance with local regulations.

## Charging AC Adapter

- Be sure to read and follow the warnings of "For Your Safety" (📖vi to viii) thoroughly before using the Charging AC Adapter.
- The Charging AC Adapter EH-69P is for use only with compatible devices. Do not use with another make or model of device.
- The EH-69P is compatible with AC 100-240 V, 50/60 Hz electrical outlets. When using in other countries, use a plug adapter (commercially available) as necessary. For more information about plug adapters, consult your travel agency.
- Do not, under any circumstances, use another make or model of AC adapter other than the Charging AC Adapter EH-69P or USB-AC adapter. Failure to observe this precaution could result in overheating or in damage to the camera.

## The Memory Cards

- Use only Secure Digital memory cards. See “Approved Memory Cards” (📖21).
- Be sure to observe the precautions in the memory card documentation when you use the memory card.
- Do not affix labels or stickers to the memory card.
- Do not format the memory card using a computer.
- When a memory card that has been used in another device is used for the first time, be sure to format it with this camera.  
When a new memory card is used, it is recommended to format it with this camera first.
- Formatting permanently deletes all data in the memory card. Be sure to transfer important pictures to a computer before formatting.
- If the error message “Card is not formatted. Format card?” is displayed when you insert a memory card into this camera, the memory card must be formatted. If the memory card contains images you wish to keep, select **No** and save those images on your computer before formatting the memory card. To format the card, select **Yes** and press the **OK** button.
- Do not perform the following during formatting, while data is being written to or deleted from the memory card, or during data transfer to a computer. Failure to observe this precaution could result in loss of data or damage to the memory card:
  - Open the battery-chamber/memory card slot cover to remove the battery or memory card.
  - Turn off the camera
  - Disconnect the AC adapter

## Caring for the Camera

### Cleaning

Lens/ viewfinder	Avoid touching glass parts with your fingers. Remove dust or lint with a blower (typically a small device with a rubber bulb attached to one end that is pumped to produce a stream of air out the other end). To remove fingerprints, oily substances, or other stains that cannot be removed with a blower, carefully wipe the lens with a dry soft cloth or eyewear cleaning cloth, using a spiral motion that starts at the center of the lens and working toward the edges. Do not wipe the lens forcibly or with a hard material. Failure to observe this precaution could result in damage or trouble. If this fails, clean the lens using a cloth lightly dampened with commercial lens cleaner.
Monitor	Remove dust or lint with a blower. To remove fingerprints, oily substances or other stains, carefully wipe the monitor with a dry soft cloth or eyewear cleaning cloth. Do not wipe the monitor forcibly or with a hard material. Failure to observe this precaution could result in damage or trouble.
Body	Use a blower to remove dust, dirt, or sand, then wipe gently with a soft, dry cloth. After using the camera at the beach or other sandy or dusty environment, wipe off any sand, dust, or salt with a dry cloth lightly dampened with fresh water and dry thoroughly. <b>Note that foreign matter inside the camera could cause damage not covered by the warranty.</b>

Do not use volatile organic solvents such as alcohol or thinner, chemical detergents, anticorrosive agents, or anti-fogging agents.

### Storage

Remove the battery if the camera will not be used for an extended period. Do not store the camera with naphtha or camphor moth balls, or in any of the following locations:

- Next to equipment that produces strong electromagnetic fields, such as televisions or radios
- Exposed to temperatures below  $-10^{\circ}\text{C}$  ( $14^{\circ}\text{F}$ ) or above  $50^{\circ}\text{C}$  ( $122^{\circ}\text{F}$ )
- Places that are poorly ventilated or subject to humidity of over 60%

To prevent mold or mildew, take the camera out of storage at least once a month. Turn the camera on and release the shutter a few times before putting the camera away again.



Be sure to read and follow the warnings given in “The Battery” (🔋:3) of “Caring for the Products” to store the battery.

# Troubleshooting













If the camera fails to function as expected, check the list of common problems below before consulting your retailer or Nikon-authorized service representative. Refer to the page numbers in the right-most column for more information.

- See “Error Messages” (🔍85) for more information.

## Power, Display, Settings Issues

Problem	Cause/Solution	
The camera is on but does not respond.	<ul style="list-style-type: none"> <li>• Wait for recording to end.</li> <li>• If the problem persists, turn the camera off. If the camera does not turn off, remove and reinsert the battery or batteries or, if you are using an AC adapter, disconnect and reconnect the AC adapter.</li> </ul> <p>Note that although any data currently being recorded will be lost, data that have already been recorded will not be affected by removing or disconnecting the power source.</p>	– 23
The battery inserted in the camera cannot be charged.	Confirm all connections.	18
The battery cannot be charged by connecting the camera to a computer.	<ul style="list-style-type: none"> <li>• <b>Off</b> is selected for <b>Charge by computer</b> in the setup menu.</li> <li>• When charging by connecting the camera to a computer, battery charging stops when the camera is turned off.</li> <li>• When charging by connecting the camera to a computer, battery charging stops when the computer is suspended (sleeping), and the camera may turn off.</li> <li>• Depending upon computer specifications, settings, and status, charging the battery inserted in the camera may not be possible via computer connection.</li> </ul>	105, 🔍76 🔍76 🔍76 –
Camera cannot be turned on.	<ul style="list-style-type: none"> <li>• Battery is exhausted.</li> <li>• The camera does not turn on while the Charging AC Adapter is connected to it even when you press the power switch. Press and hold the  (playback) button to turn on the camera in playback mode. However, shooting is not possible.</li> </ul>	22 –
Camera turns off without warning.	<ul style="list-style-type: none"> <li>• Battery is exhausted.</li> <li>• If no operations are performed for a while, camera has turned off automatically by auto off to save power.</li> <li>• The camera turns off if the Charging AC Adapter is connected while the camera is on.</li> <li>• The camera turns off if the USB cable connecting the camera to a computer or printer is disconnected. Reconnect the USB cable.</li> <li>• Inside of the camera has become hot. Leave the camera off until the inside of the camera has cooled.</li> <li>• At low temperatures, the camera and the battery may not function normally.</li> </ul>	22 23 18 87, 90, 🔍19 – 🔍3







## Troubleshooting

Problem	Cause/Solution	
Monitor or viewfinder is blank.	<ul style="list-style-type: none"> <li>• Camera is off.</li> <li>• Battery is exhausted.</li> <li>• Standby mode for saving power: Press the power switch, shutter-release button,  button or  button, or rotate the mode dial.</li> <li>• Monitor and viewfinder cannot be used simultaneously. It may take some time to switch between monitor and viewfinder.</li> <li>• Camera and computer are connected via USB cable.</li> <li>• Camera and TV are connected via audio/video cable or HDMI cable.</li> <li>• Interval timer shooting in progress.</li> </ul>	23 22 23  8  87, 90 87,  17   36
Monitor screen is hard to see.	<ul style="list-style-type: none"> <li>• Ambient lighting too bright: move to darker location or use viewfinder.</li> <li>• Adjust monitor screen brightness.</li> <li>• Monitor is dirty. Clean monitor screen.</li> </ul>	8  103,  67  6
The viewfinder is hard to see.	Adjust diopter adjustment control.	8
Date and time of recording are not correct.	<ul style="list-style-type: none"> <li>• If the camera clock has not been set ("Date not set" indicator flashes during shooting), still pictures have a time stamp of "00/00/0000 00:00"; and movies are dated "01/01/2013 00:00." Set the correct date and time using <b>Time zone and date</b> in the setup menu.</li> <li>• The camera clock is not as accurate as a normal clock, such as watches. Check camera clock regularly against more accurate timepieces and reset as required.</li> </ul>	24, 103,  65  103,  65
No information displayed on the monitor.	Shooting and photo information may be hidden. Press the <b>DISP</b> button until shooting information or photo information is displayed.	9
<b>Print date</b> not available.	<b>Time zone and date</b> in the setup menu has not been set.	24, 103,  65
Date not appearing on pictures even when <b>Print date</b> is enabled.	<ul style="list-style-type: none"> <li>• A shooting mode that does not support print date is selected.</li> <li>• Another function that is set now is restricting the print date.</li> <li>• The date cannot be imprinted onto a movie.</li> </ul>	103,  68 75 –
Screen for setting time zone and date is displayed when camera is turned on.	Clock battery is exhausted; all settings were restored to their default values.	25
Camera settings reset.		
<b>Reset file numbering</b> cannot be done.	<b>Reset file numbering</b> cannot be applied when the folder number reaches 999 and there are images in the folder. Change the memory card, or format the internal memory/memory card.	105,  78





















Problem	Cause/Solution	
Monitor is turned off, and the power-on lamp flashes quickly.	Battery temperature is high. Turn off camera, and allow battery to cool down before resuming use. After the lamp flashes for 3 minutes, the camera turns off automatically, but you can also press the power switch to turn it off manually.	23
Camera temperature rises.	When functions such as movie recording or sending images using an Eye-Fi card are used for a long time, or when the camera is used in a location with a high ambient temperature, the camera temperature may rise. This is not a malfunction.	94

## Shooting Issues







Problem	Cause/Solution	
Cannot set to shooting mode.	Disconnect the HDMI cable or USB cable.	87, 90,  17,  19
No picture can be taken.	<ul style="list-style-type: none"> <li>When camera is in playback mode, press the  button, shutter-release button or  (movie-record) button.</li> <li>When menus are displayed, press the <b>MENU</b> button.</li> <li>Battery is exhausted.</li> <li>When the scene mode is <b>Night portrait</b> or  (Backlighting) with <b>HDR</b> set to <b>Off</b>, raise the flash.</li> <li>When flash lamp flashes, flash is charging.</li> </ul>	32 10 22 38, 40, 56 56
Cannot take 3D images	In some shooting conditions, such as when the subject moves or the subject is dark or low in contrast, the second shot may not be taken or the 3D image may not be saved.	–
Camera cannot focus.	<ul style="list-style-type: none"> <li>Incorrect focus mode setting. Check or change the setting.</li> <li>The intended subject is one with which autofocus does not perform well.</li> <li>Set <b>AF assist</b> in the setup menu to <b>Auto</b>.</li> <li>Subject is not in focus area when shutter-release button is pressed halfway.</li> <li>The focus mode is set to <b>MF</b> (manual focus).</li> <li>Turn camera off and then on again.</li> </ul>	62, 63 81 104,  71 30, 69 62 23
Colored stripes appear on the monitor when shooting.	Colored stripes may appear when shooting subjects with repeating patterns (such as window blinds); this is not a malfunction. The colored stripes will not appear in captured images or recorded movies. However, when using <b>Continuous H: 120 fps</b> or <b>HS 480/4x</b> , the colored stripes may be seen in the captured images and recorded movies.	–
Pictures are blurred.	<ul style="list-style-type: none"> <li>Use flash.</li> <li>Use vibration reduction or motion detection.</li> <li>Use <b>BSS</b> (Best Shot Selector).</li> <li>Use a tripod to stabilize the camera (use with the self-timer for better results).</li> </ul>	56 104, 104 68 59



## Troubleshooting

Problem	Cause/Solution	
Bright specks appear in pictures shot using flash.	Flash is reflecting off particles in air. Lower the flash.	56
Flash does not fire.	<ul style="list-style-type: none"> <li>A shooting mode where flash cannot fire is selected.</li> <li>Another function that is set now is restricting the flash.</li> </ul>	65 75
The digital zoom is not available.	<ul style="list-style-type: none"> <li><b>Off</b> is selected for <b>Digital zoom</b> in the setup menu.</li> <li>When  (Backlighting) (<b>HDR</b> setting is other than <b>Off</b>), <b>Scene auto selector</b>, <b>Portrait</b>, <b>Night portrait</b>, <b>Easy panorama</b> in <b>Panorama</b>, <b>Pet portrait</b> or <b>3D photography</b> is selected in scene mode, the digital zoom cannot be used.</li> <li>Other functions that restrict the use of digital zoom are set.</li> </ul>	104 38, 39, 39, 40, 43, 44, 45  75
<b>Image size</b> not available.	<ul style="list-style-type: none"> <li>Another function that is set now is restricting <b>Image size</b>.</li> <li>When the scene mode is set to <b>Easy panorama</b> in <b>Panorama</b> or <b>3D photography</b>, the image size is fixed.</li> </ul>	75 43, 45
No sound when shutter is released.	<ul style="list-style-type: none"> <li><b>Off</b> is selected for <b>Shutter sound</b> under <b>Sound settings</b> in the setup menu.</li> <li><b>Sports</b>, <b>Museum</b> or <b>Pet portrait</b> is selected in scene mode.</li> <li>Other functions that restrict the use of the shutter sound are set.</li> <li>Do not block the speaker.</li> </ul>	104 40, 42, 44 75  2
AF-assist illuminator does not light.	<b>Off</b> is selected for <b>AF assist</b> in the setup menu. Even when <b>Auto</b> is set, AF-assist illuminator may not light depending on the focus area position or scene mode.	104
Pictures appear smeared.	Lens is dirty. Clean lens.	 6
Colors are unnatural.	White balance does not match light source.	68,  31
Ring-shaped or rainbow-colored bands are seen on the screen or the shot image.	When the subject is backlit or when shooting with an extremely bright light source in the display, such as in sunlight, ring-shaped or rainbow-colored bands may appear on the image. Change the position of the light source or remove it from the display, and try shooting again.	–
The image taken becomes grainy.	As the subject is dark, shutter speed is too slow or ISO sensitivity is too high. <ul style="list-style-type: none"> <li>Use flash.</li> <li>Specify a lower ISO sensitivity setting.</li> </ul>	56 69,  38
Pictures are too dark (underexposed).	<ul style="list-style-type: none"> <li>Flash window is blocked.</li> <li>Subject is beyond flash range.</li> <li>Adjust exposure compensation.</li> <li>Raise the ISO sensitivity.</li> <li>Subject is backlit. Raise the flash, and set the scene mode  (Backlighting) with <b>HDR</b> set to <b>Off</b> or set the flash mode to  (fill flash).</li> </ul>	28 56 64 69,  38 38, 56





Problem	Cause/Solution	
Pictures are too bright (overexposed).	Adjust exposure compensation.	64
Areas not affected by red-eye are also corrected.	When  (auto with red-eye reduction) or “fill flash with red-eye reduction” of the <b>Night portrait</b> scene mode is applied during shooting, In-Camera Red-Eye Fix may, in very rare cases, be applied to areas not affected by red-eye. Set the flash mode to other than  , select a scene mode other than <b>Night portrait</b> , and resume shooting.	40, 56
Skin softening results are not as expected.	<ul style="list-style-type: none"> <li>• Skin softening may not produce the desired results depending on shooting conditions.</li> <li>• For pictures with 4 or more faces, try using <b>Skin softening</b> in the playback menu.</li> </ul>	46 84,  13
Saving images takes time.	It may take more time to save images in the following situations. <ul style="list-style-type: none"> <li>• When the noise reduction function is in operation</li> <li>• When flash is set to  (auto with red-eye reduction)</li> <li>• When taking pictures in the following scene modes.                             <ul style="list-style-type: none"> <li>- <b>Hand-held</b> in  (Night landscape)</li> <li>- <b>Noise reduction burst</b> in  (Landscape) or <b>Close-up</b></li> <li>- <b>HDR</b> set to other than <b>Off</b> in  (Backlighting)</li> <li>- <b>Easy panorama</b> in <b>Panorama</b></li> </ul> </li> <li>• <b>Continuous</b> in the shooting menu is set to <b>Continuous H: 120 fps</b> or <b>Continuous H: 60 fps</b></li> <li>• When using smile timer while shooting</li> <li>• When using Active D-Lighting while shooting</li> </ul>	– 57 37 38, 41 38 43 68,  34 60 69,  46
Cannot set or use <b>Continuous</b> or <b>Exposure bracketing</b> .	Another function that is set now is restricting <b>Continuous</b> or <b>Exposure bracketing</b> .	75
Cannot set COOLPIX Picture Control.	Another function that is set now is restricting COOLPIX Picture Control.	75

## Playback Issues

Problem	Cause/Solution	
File cannot be played back.	<ul style="list-style-type: none"> <li>File was overwritten or renamed by computer or another make or model of camera.</li> <li>File cannot be played back during interval timer shooting.</li> <li>Movies recorded with cameras other than the COOLPIX P520 cannot be played back.</li> </ul>	– 68 92
Cannot play a sequence.	<ul style="list-style-type: none"> <li>Pictures shot continuously with cameras other than the COOLPIX P520 cannot be played as a sequence.</li> <li>Check the <b>Sequence display options</b> setting.</li> </ul>	– 85,  58
Cannot zoom in on picture.	<ul style="list-style-type: none"> <li>Playback zoom cannot be used with movies, small pictures, or cropped copies of size 320 × 240 pixels or smaller.</li> <li>Playback zoom may not be available for pictures taken with cameras other than the COOLPIX P520.</li> <li>3D images cannot be enlarged when the camera is connected via HDMI and they are played back in 3D.</li> </ul>	– – 45
Cannot record or play back voice memo.	<ul style="list-style-type: none"> <li>Voice memos cannot be attached to movies.</li> <li>Voice memos cannot be attached to pictures taken with cameras other than the COOLPIX P520, and voice memos recorded by other cameras cannot be played back.</li> </ul>	97 85
Pictures and movies cannot be edited.	<ul style="list-style-type: none"> <li>Confirm the conditions that are required for editing pictures or movies.</li> <li>Pictures and movies taken with cameras other than the COOLPIX P520 cannot be edited.</li> </ul>	85,  11,  24 –
Pictures are not displayed on television.	<ul style="list-style-type: none"> <li><b>Video mode</b> or <b>HDMI</b> is not correctly set in the <b>TV settings</b> setup menu.</li> <li>HDMI output is disabled when the camera is connected to either a computer or printer with a USB cable.</li> <li>Memory card contains no pictures. Replace memory card. Remove memory card to play back pictures from internal memory.</li> </ul>	105,  75 87 20
Nikon Transfer 2 does not start when camera is connected to a computer.	<ul style="list-style-type: none"> <li>Camera is off.</li> <li>Battery is exhausted.</li> <li>USB cable is not correctly connected.</li> <li>Camera is not recognized by the computer.</li> <li>Confirm that the operating system used is compatible with the camera.</li> <li>Computer is not set to launch Nikon Transfer 2 automatically. For more information on Nikon Transfer 2, refer to help information contained in ViewNX 2.</li> </ul>	23 22 87 – 88 91
The PictBridge startup screen is not displayed when the camera is connected to a printer.	With some PictBridge-compatible printers, the PictBridge startup screen may not be displayed and it may be impossible to print images when <b>Auto</b> is selected for the <b>Charge by computer</b> option. Set the <b>Charge by computer</b> option to <b>Off</b> and reconnect the camera to the printer.	105,  76

Problem	Cause/Solution	
Pictures to be printed are not displayed.	<ul style="list-style-type: none"> <li>• Memory card contains no pictures. Replace memory card.</li> <li>• Remove memory card to print pictures from internal memory.</li> <li>• Pictures taken by 3D photography cannot be printed.</li> </ul>	20 21 45
Cannot select paper size with camera.	Paper size cannot be selected from the camera in the following situations, even for PictBridge compatible printers. Use the printer to select paper size. <ul style="list-style-type: none"> <li>• The paper size selected using the camera is not compatible with the printer.</li> <li>• A printer that automatically sets the paper size is being used.</li> </ul>	 20,  21 –

## GPS

Problem	Cause/Solution	
Unable to identify the location or it takes time to identify the location.	<ul style="list-style-type: none"> <li>• The camera may not be able to identify the location in some shooting environments. To use the GPS feature, use the camera as much as possible in an open-air area.</li> <li>• When positioning for the first time, when positioning was unable to be performed for about two hours, or after the battery was changed, it takes a few minutes to obtain the positioning information.</li> </ul>	99  99
Unable to record position information on shot images.	When signals are not received from the satellites and positioning cannot be performed, the position information is not recorded. Before shooting pictures, check the GPS reception indicator.	100
Difference between the actual shooting location and recorded position information.	The acquired position information may deviate in some shooting environments. When there is a significant difference in the signals from the GPS satellites, there could be a deviation of up to several hundred meters.	98
An incorrect location name is recorded or the correct location name is not displayed.	The desired landmark name may not be registered or an incorrect landmark name may be displayed.	-
Unable to update the A-GPS file.	<ul style="list-style-type: none"> <li>• Check the following items.                             <ul style="list-style-type: none"> <li>- Whether the memory card is inserted</li> <li>- Whether the A-GPS file is stored on the memory card</li> <li>- Whether the A-GPS file saved on the memory card is more recent than the A-GPS file saved in the camera</li> <li>- Whether the A-GPS file is still valid</li> </ul> </li> <li>• The A-GPS file may be corrupted. Download the file from the website once more.</li> </ul>	-   59
Unable to select <b>Create log</b> in the GPS options menu.	Clock not set. Set date and time.	103,  65
Unable to select <b>Start log</b> .	<ul style="list-style-type: none"> <li>• <b>Record GPS data</b> in <b>GPS options</b> of the GPS options menu is set to <b>Off</b>.</li> <li>• Recording log data. Select <b>End log</b> and finish log recording to start a new log.</li> </ul>	98  102,  61
Unable to save log data.	<ul style="list-style-type: none"> <li>• Be sure that a memory card is inserted in the camera.</li> <li>• Up to 36 log data events can be recorded in a day.</li> <li>• Up to 100 log data events can be stored on a single memory card. Delete log data that is no longer required from a memory card or replace the memory card with a new one.</li> </ul>	- -  63

# USER LICENSE AGREEMENT FOR LOCATION NAME DATA

The location name data that are stored in this digital camera ("Data") is provided for your personal, internal use only and not for resale. It is protected by copyright, and is subject to the following terms and conditions which are agreed to by you, on the one hand, and Nikon Corporation ("Nikon") and its licensors (including their licensors and suppliers) on the other hand.

## Terms and Conditions

**Personal Use Only.** You agree to use this Data together with this digital camera and the image data taken by the digital camera for the solely personal, non-commercial purposes for which you were licensed, and not for service bureau, time-sharing or other similar purposes.

Accordingly, but subject to the restrictions set forth in the following paragraphs, you agree not to otherwise reproduce, copy, modify, decompile, disassemble or reverse engineer any portion of this Data, and may not transfer or distribute it in any form, for any purpose, except to the extent permitted by mandatory laws.

**Restrictions.** Except where you have been specifically licensed to do so by Nikon, and without limiting the preceding paragraph, you may not (a) use this Data with any products, systems, or applications installed or otherwise connected to or in communication with vehicles, capable of vehicle navigation, positioning, dispatch, real time route guidance, fleet management or similar applications; or (b) with or in communication with any positioning devices or any mobile or wireless-connected electronic or computer devices, including without limitation cellular phones, palmtop and handheld computers, pagers, and personal digital assistants or PDAs.

**Warning.** The Data may contain inaccurate or incomplete information due to the passage of time, changing circumstances, sources used and the nature of collecting comprehensive geographic data, any of which may lead to incorrect results.

**No Warranty.** This Data is provided to you "as is," and you agree to use it at your own risk. Nikon and its licensors (and their licensors and suppliers) make no guarantees, representations

or warranties of any kind, express or implied, arising by law or otherwise, including but not limited to, content, quality, accuracy, completeness, effectiveness, reliability, fitness for a particular purpose, usefulness, use or results to be obtained from this Data, or that the Data or server will be uninterrupted or error-free.

**Disclaimer of Warranty:** NIKON AND ITS LICENSORS (INCLUDING THEIR LICENSORS AND SUPPLIERS) DISCLAIM ANY WARRANTIES, EXPRESS OR IMPLIED, OF QUALITY, PERFORMANCE, MERCHANTABILITY, FITNESS FOR A PARTICULAR PURPOSE OR NON-INFRINGEMENT.

Some States, Territories and Countries do not allow certain warranty exclusions, so to that extent the above exclusion may not apply to you.

**Disclaimer of Liability:** NIKON AND ITS LICENSORS (INCLUDING THEIR LICENSORS AND SUPPLIERS) SHALL NOT BE LIABLE TO YOU: IN RESPECT OF ANY CLAIM, DEMAND OR ACTION, IRRESPECTIVE OF THE NATURE OF THE CAUSE OF THE CLAIM, DEMAND OR ACTION ALLEGING ANY LOSS, INJURY OR DAMAGES, DIRECT OR INDIRECT, WHICH MAY RESULT FROM THE USE OR POSSESSION OF THE INFORMATION; OR FOR ANY LOSS OF PROFIT, REVENUE, CONTRACTS OR SAVINGS, OR ANY OTHER DIRECT, INDIRECT, INCIDENTAL, SPECIAL OR CONSEQUENTIAL DAMAGES ARISING OUT OF YOUR USE OF OR INABILITY TO USE THIS INFORMATION, ANY DEFECT IN THE INFORMATION, OR THE BREACH OF THESE TERMS OR CONDITIONS, WHETHER IN AN ACTION IN CONTRACT OR TORT OR BASED ON A WARRANTY, EVEN IF NIKON OR ITS LICENSORS HAVE BEEN ADVISED OF THE POSSIBILITY OF SUCH DAMAGES. Some States, Territories and Countries do not allow certain liability exclusions or damages limitations, so to that extent the above may not apply to you.

## USER LICENSE AGREEMENT FOR LOCATION NAME DATA

Export Control. You agree not to export from anywhere any part of the Data or any direct product thereof except in compliance with, and with all licenses and approvals required under, applicable export laws, rules and regulations, including but not limited to the laws, rules and regulations administered by the Office of Foreign Assets Control of the U.S. Department of Commerce and the Bureau of Industry and Security of the U.S. Department of Commerce.

To the extent that any such export laws, rules or regulations prohibit Nikon and its licensors from complying with any of its obligations hereunder to deliver or distribute Data, such failure shall be excused and shall not constitute a breach of this Agreement.

Entire Agreement. These terms and conditions constitute the entire agreement between Nikon (and its licensors, including their licensors and suppliers) and you pertaining to the subject matter hereof, and supersedes in their entirety any and all written or oral agreements previously existing between us with respect to such subject matter.

Governing Law. The above terms and conditions shall be governed by the laws of the Japan, without giving effect to (i) its conflict of laws provisions, or (ii) the United Nations Convention for Contracts for the International Sale of Goods, which is explicitly excluded; provided that in the event that the laws of the Japan is not deemed applicable to this Agreement for any reason in the country where you obtained the Data, this Agreement shall be governed with the laws of the country where you obtained the Data. You agree to submit to the jurisdiction of Japan for any and all disputes, claims and actions arising from or in connection with the Data provided to you hereunder.

Government End Users. If the Data supplied by NAVTEQ is being acquired by or on behalf of the United States government or any other entity seeking or applying rights similar to those customarily claimed by the United States government, the Data is a "commercial item" as that term is defined at 48 C.F.R. ("FAR") 2.101, is licensed in accordance with the End-User Terms under which this Data was provided, and each instruction manual accompanying the Client device containing a copy of the Data delivered or otherwise furnished shall be marked and embedded as appropriate with the following "Notice of Use," and shall be treated in accordance with such Notice:

<p style="text-align: center;">Notice of Use</p> <p>Contractor (Manufacturer/ Supplier) Name: NAVTEQ</p> <p>Contractor (Manufacturer/Supplier) Address: c/o Nokia 425 West Randolph Street, Chicago, Illinois 60606</p> <p>This Data is a commercial item as defined in FAR 2.101 and is subject to the End-User Terms under which this Data was provided.</p> <p>© 2012 NAVTEQ - All rights reserved.</p>
--

If the Contracting Officer, federal government agency, or any federal official refuses to use the legend provided herein, the Contracting Officer, federal government agency, or any federal official must notify NAVTEQ prior to seeking additional or alternative rights in the Data.



## Notices related to licensed software copyright holders.

- Location name data for Japan



© 2012 ZENRIN CO., LTD. All rights reserved.  
This service uses POI data of ZENRIN CO., LTD.  
"ZENRIN" is a registered trademark of ZENRIN CO., LTD.

- Location name data except for Japan



© 1993-2012 NAVTEQ. All rights reserved.  
NAVTEQ Maps is a trademark of NAVTEQ.

Austria	© Bundesamt für Eich- und Vermessungswesen
Croatia Cyprus Estonia Latvia Lithuania Moldova Poland Slovenia Ukraine	© EuroGeographics
France	source: © IGN 2009 - BD TOPO ®
Germany	"Die Grundlagendaten wurden mit Genehmigung der zuständigen Behörden entnommen"
Great Britain	Contains Ordnance Survey data © Crown copyright and database right 2010 Contains Royal Mail data © Royal Mail copyright and database right 2010
Greece	Copyright Geomatics Ltd.
Hungary	Copyright © 2003; Top-Map Ltd.
Italy	La Banca Dati Italiana è stata prodotta usando quale riferimento anche cartografia numerica ed al tratto prodotta e fornita dalla Regione Toscana.
Norway	Copyright © 2000; Norwegian Mapping Authority
Portugal	Source: IgeoE - Portugal
Spain	Información geográfica propiedad del CNIG
Sweden	Based upon electronic data © National Land Survey Sweden.

## USER LICENSE AGREEMENT FOR LOCATION NAME DATA

Switzerland	Topografische Grundlage: © Bundesamt für Landestopographie
Canada	This data includes information taken with permission from Canadian authorities, including © Her Majesty, © Queen's Printer for Ontario, © Canada Post, GeoBase ®, © Department of Natural Resources Canada. All rights reserved.
Mexico	Fuente: INEGI (Instituto Nacional de Estadística y Geografía.)
United States	© United States Postal Service ® 2012. Prices are not established, controlled or approved by the United States Postal Service ®. The following trademarks and registrations are owned by the USPS: United States Postal Service, USPS, and ZIP+4.
Australia	Copyright. Based on data provided under license from PSMA Australia Limited (www.psm.com.au). Product incorporates data which is © 2012 Telstra Corporation Limited, GM Holden Limited, Intelomatics Australia Pty Ltd and Continental Pty Ltd.
Nepal	Copyright © Survey Department, Government of Nepal.
Sri Lanka	This product incorporates original source digital data obtained from the Survey Department of Sri Lanka © 2009 Survey Department of Sri Lanka The data has been used with the permission of the Survey Department of Sri Lanka
Israel	© Survey of Israel data source
Jordan	"© Royal Jordanian Geographic Centre".
Mozambique	Certain Data for Mozambique provided by Cenacarta © 2012 by Cenacarta
Réunion	source: © IGN 2009 - BD TOPO ®
Ecuador	INSTITUTO GEOGRAFICO MILITAR DEL ECUADRO AUTORIZACION N° IGM-2011-01- PCO-01 DEL 25 DE ENERO DE 2011
Guadeloupe	source: © IGN 2009 - BD TOPO ®
Guatemala	Aprobado por el INSTITUTO GEOGRAFICO NACIONAL - Resolución del IGN N° 186-2011
French Guiana	source: © IGN 2009 - BD TOPO ®
Martinique	source: © IGN 2009 - BD TOPO ®
Mexico	Fuente: INEGI (Instituto Nacional de Estadística y Geografía)

# Specifications

## Nikon COOLPIX P520 Digital Camera

Type	Compact digital camera
Number of effective pixels	18.1 million
Image sensor	1/2.3-in. type CMOS; approx. 18.91 million total pixels
Lens	NIKKOR lens with 42x optical zoom
Focal length	4.3-180 mm (angle of view equivalent to that of 24-1000 mm lens in 35mm [135] format)
f/-number	f/3-5.9
Construction	14 elements in 10 groups (4 ED lens elements)
Digital zoom magnification	Up to 2x (angle of view equivalent to that of approx. 2000 mm lens in 35mm [135] format)
Vibration reduction	Lens shift
Motion blur reduction	Motion detection (still pictures)
Autofocus (AF)	Contrast-detect AF
Focus range	<ul style="list-style-type: none"><li>• [W]: Approx. 50 cm (1 ft 8 in.) - <math>\infty</math>,</li><li>  [T]: Approx. 2.0 m (6 ft 7 in.) - <math>\infty</math></li><li>• Macro close-up mode: Approx. 1 cm (0.4 in.) (at a wide-angle zoom position) - <math>\infty</math></li></ul> (All distances measured from center of front surface of lens)
Focus-area selection	Face priority, auto (9-area automatic selection), center (wide, normal), manual with 99 focus areas, subject tracking, target finding AF
Viewfinder	Electronic viewfinder, 0.5 cm (0.2-in.) approx. 201k-dot equivalent LCD with the diopter adjustment function (-4 to +4 m <sup>-1</sup> )
Frame coverage (shooting mode)	Approx. 100% horizontal and 100% vertical (compared to actual picture)
Frame coverage (playback mode)	Approx. 100% horizontal and 100% vertical (compared to actual picture)
Monitor	8 cm (3.2-in.), approx. 921k-dot, wide viewing angle TFT LCD with anti-reflection coating and 5-level brightness adjustment, Vari-angle TFT LCD
Frame coverage (shooting mode)	Approx. 100% horizontal and 100% vertical (compared to actual picture)
Frame coverage (playback mode)	Approx. 100% horizontal and 100% vertical (compared to actual picture)
Storage	
Media	Internal memory (approx. 15 MB) SD/SDHC/SDXC memory card
File system	DCF, Exif 2.3, DPOF, and MPF compliant
File formats	Still pictures: JPEG 3D images: MPO Sound files (voice memo): WAV Movies: MOV (Video: H.264/MPEG-4 AVC, Audio: AAC stereo)

## Specifications

Image size (pixels)	<ul style="list-style-type: none"> <li>• 18 M <b>4896x3672</b></li> <li>• 4 M <b>2272x1704</b></li> <li>• VGA <b>640x480</b></li> <li>• 16:9 2M <b>1920x1080</b></li> <li>• 1:1 <b>3672x3672</b></li> <li>• 8 M <b>3264x2448</b></li> <li>• 2 M <b>1600x1200</b></li> <li>• 16:9 13M <b>4864x2736</b></li> <li>• 3:2 <b>4896x3264</b></li> </ul>
ISO sensitivity (Standard output sensitivity)	<ul style="list-style-type: none"> <li>• ISO 80 - 1600</li> <li>• ISO 3200, Hi 1 (equivalent to ISO 6400) (available when using <b>P</b>, <b>S</b>, <b>A</b> or <b>M</b> mode)</li> <li>• ISO Hi 2 (equivalent to ISO 12800) (available when using <b>High ISO monochrome</b> in special effects mode)</li> </ul>
Exposure	
Metering mode	Matrix, center-weighted, or spot.
Exposure control	Programmed auto (with flexible program), shutter priority auto, aperture-priority auto, manual, exposure bracketing, exposure compensation (-2.0 EV - +2.0 EV in steps of 1/3 EV)
Shutter	Mechanical and CMOS electronic shutter
Speed	<ul style="list-style-type: none"> <li>• 1/4000 * - 1 s</li> <li>• 1/4000 * - 8 s (when ISO sensitivity is fixed at 80 or 100 in <b>P</b>, <b>S</b>, <b>A</b> or <b>M</b> mode mode)</li> </ul> * When the aperture value is set between f/6.6 and f/8.3 at the wide-angle end.
Aperture	Electronically-controlled 6-blade iris diaphragm
Range	10 steps of 1/3 EV (W) ( <b>A</b> , <b>M</b> mode)
Self-timer	Durations of 2 or 10 seconds can be selected
Flash	
Range (approx.) (ISO sensitivity: Auto)	[W]: 0.5 - 8.0 m (1 ft 8 in. - 26 ft) [T]: 1.5 - 4.5 m (5 - 14 ft)
Flash control	TTL auto flash with monitor preflashes
Flash exposure compensation	In steps of 1/3 EV in the range between -2 and +2 EV
Interface	Hi-Speed USB
Data transfer protocol	MTP, PTP
Video output	Can be selected from NTSC and PAL
HDMI output	Can be selected from Auto, 480p, 720p, and 1080i
I/O terminal	<ul style="list-style-type: none"> <li>• Audio/video output; digital I/O (USB)</li> <li>• HDMI mini connector (Type C) (HDMI output)</li> </ul>
GPS	Receiver frequency 1575.42 MHz (C/A code), geodetic system WGS 84
Supported languages	Arabic, Bengali, Chinese (Simplified and Traditional), Czech, Danish, Dutch, English, Finnish, French, German, Greek, Hindi, Hungarian, Indonesian, Italian, Japanese, Korean, Marathi, Norwegian, Persian, Polish, Portuguese (European and Brazilian), Romanian, Russian, Spanish, Swedish, Tamil, Telugu, Thai, Turkish, Ukrainian, Vietnamese

Power sources	<ul style="list-style-type: none"> <li>• One Rechargeable Li-ion Battery EN-EL5 (included)</li> <li>• AC Adapter EH-62A (available separately)</li> </ul>
Charging time	Approx. 4 h and 30 min (when using Charging AC Adapter EH-69P and when no charge remains)
Battery life (Still pictures)*	Approx. 200 shots when using EN-EL5
Tripod socket	1/4 (ISO 1222)
Dimensions (W × H × D)	Approx. 125.2 × 84.1 × 101.6 mm (5.0 × 3.4 × 4.0 in.) (excluding projections)
Weight	Approx. 550 g (1 lb 3.5 oz) (including battery and SD memory card)
Operating environment	
Temperature	0°C - 40°C (32°F - 104°F)
Humidity	85% or less (no condensation)

- Unless otherwise stated, all figures assume a fully-charged battery and an ambient temperature of 23 ±3°C (73.4 ±5.4°F) as specified by the Camera and Imaging Products Association (CIPA).

\* Figures based on the Camera and Imaging Products Association (CIPA) standards for measuring the endurance of camera batteries. Performance for still pictures measured under the following test conditions: **Normal** selected for Image quality, **18M 4896×3672** selected for Image size, zoom adjusted with each shot, and flash fired with every other shot. The values may vary depending on operating conditions such as the interval between shots and the length of time menus and images are displayed.

## Specifications

### Rechargeable Li-ion Battery EN-EL5

Type	Rechargeable lithium-ion battery
Rated capacity	DC 3.7 V, 1100 mAh
Operating temperature	0°C - 40°C (32°F - 104°F)
Dimensions (W × H × D)	Approx. 36 × 54 × 8 mm (1.4 × 2.1 × 0.3 in.)
Weight	Approx. 30 g (1.1 oz) (excluding terminal cover)

### Charging AC Adapter EH-69P

Rated input	AC 100-240 V, 50/60 Hz, 0.068-0.042 A
Rated output	DC 5.0 V, 550 mA
Operating temperature	0°C - 40°C (32°F - 104°F)
Dimensions (W × H × D)	Approx. 55 × 22 × 54 mm (2.2 × 0.9 × 2.2 in.) (excluding plug adapter) For Argentina: Approx. 55 × 59 × 63 mm (2.2 × 2.4 × 2.5 in.) For Korea: Approx. 55 × 59 × 66.5 mm (2.2 × 2.4 × 2.7 in.)
Weight	Approx. 55 g (2.0 oz) (excluding plug adapter) For Argentina and Korea: Approx. 80 g (2.9 oz)

### Specifications

- Nikon will not be held liable for any errors this manual may contain.
- The appearance of this product and its specifications are subject to change without notice.

## Supported Standards

- **DCF:** Design Rule for Camera File System is a standard widely used in the digital camera industry to ensure compatibility among different makes of camera.
- **DPOF:** Digital Print Order Format is an industry-wide standard that allows pictures to be printed at a digital photo lab or with a household printer from print orders stored on the memory card.
- **Exif version 2.3:** This camera supports Exif (Exchangeable Image File Format for Digital Still Cameras) version 2.3, a standard that allows information stored with photographs to be used for optimal color reproduction when images are output from Exif-compliant printers.  
See the instruction manual of the printer for further details.
- **PictBridge:** A standard developed cooperatively by the digital camera and printer industries, allowing photographs to be output directly to a printer without connecting the camera to a computer.

## AVC Patent Portfolio License

This product is licensed under the AVC Patent Portfolio License for the personal and non-commercial use of a consumer to (i) encode video in compliance with the AVC standard ("AVC video") and/or (ii) decode AVC video that was encoded by a consumer engaged in a personal and non-commercial activity and/or was obtained from a video provider licensed to provide AVC video. No license is granted or shall be implied for any other use. Additional information may be obtained from MPEG LA, L.L.C.

See <http://www.mpegla.com>.

## FreeType License (FreeType2)

Portions of this software are copyright © 2013 The FreeType Project ("www.freetype.org"). All rights reserved.

## MIT License (Harfbuzz)

Portions of this software are copyright © 2013 The Harfbuzz Project ("http://www.freedesktop.org/wiki/Software/HarfBuzz"). All rights reserved.

## Trademark Information

- Microsoft, Windows and Windows Vista are either registered trademarks or trademarks of Microsoft Corporation in the United States and/or other countries.
- Macintosh, Mac OS, and QuickTime are trademarks of Apple Inc., registered in the U.S. and other countries. The iFrame logo and the iFrame symbol are trademarks of Apple Inc.
- Adobe and Acrobat are registered trademarks of Adobe Systems Inc.
- SDXC, SDHC and SD Logos are trademarks of SD-3C, LLC.
- PictBridge is a trademark.
- HDMI, HDMI logo and High-Definition Multimedia Interface are trademarks or registered trademarks of HDMI Licensing LLC.

## HDMI

- Wi-Fi and the Wi-Fi logo are trademarks or registered trademarks of the Wi-Fi Alliance.
- All other trade names mentioned in this manual or the other documentation provided with your Nikon product are trademarks or registered trademarks of their respective holders.

# Index

## Symbols

45, 7

**A** Aperture-priority auto mode 49, 51

Apply selection button 5

Auto mode 26, 35

Backlighting mode 38

Delete button 33, 9, 56

**DISP** Display button 9

Exposure compensation 55, 64

Flash mode 55, 56

(flash pop-up) button 56

Focus mode 55, 62

**Fn** Function button 4, 71

Landscape mode 38

**M** Manual mode 49, 51

**MENU** Menu button 10, 67, 84, 96, 101, 103

(movie-record) button 92

Night landscape mode 37

Playback button 4, 32

Playback zoom 82

**P** Programmed auto mode 49, 51

**SCENE** Scene mode 36

Self-timer/Smile timer 55, 59, 60

**S** Shutter-priority auto mode 49, 51

**EFFECTS** Special effects mode 47

**T** Tele 29

Thumbnail display 83

**U** User settings mode 53

**W** Wide 29

.JPG 90

.MOV 90

.MPO 90

.WAV 90

## Numerics

3D photography 45

## A

AC adapter 18, 19, 92

Active D-Lighting 69, 46

AF area mode 69, 40

AF assist 104, 71

A-GPS file 101, 59

Aperture value 49

Aperture-priority auto mode 49, 51

Assign Side Zoom Control 4, 29

Assign side zoom control 104

Audio/video cable 87, 17

Audio/video-in jack 87, 17

Auto 57

Auto off 23, 104, 73

Auto with red-eye reduction 57, 58

Autofocus 63, 69, 96, 44, 51

Autofocus mode 69, 96, 44, 51

AV cable 87, 17

## B

Backlighting 38

Battery 16, 18

Battery charger 19, 92

Battery level indicator 22

Battery-chamber/memory card slot cover 16, 20

Beach 40

Best shot selector 42, 68, 34

Black and white copy 42

Blink warning 106, 79

BSS 42, 68, 34

Button sound 104, 73

## C

Calendar display 83

Charge by computer 105, 76

Charger 19, 92

Charging AC Adapter 18

Choose key picture 85, 58

Close-up 41

Command dial 3, 5, 49

Computer 87, 90

Continuous 68, 34

Contrast 28

COOLPIX Custom Picture Control 68, 30



COOLPIX Picture Control 68, 26  
 Create log **102**, 61  
 Crop 16, 24  
 Custom Picture Control **68**, 30

**D**

Date and time **24**, 65  
 Daylight saving time **24**, 66  
 Delete **33**, **97**, 9, 56  
 Digital zoom **29**, **104**, 71  
 Diopter adjustment control **8**  
 Direct Print **87**, 19  
 D-Lighting **84**, 12  
 DPOF printing 22  
 DSCN 90  
 Dusk/dawn 41

**E**

Easy panorama **43**, 3  
 Editing movies 24  
 Editing Pictures 10  
 Exposure bracketing **69**, 39  
 Exposure compensation **55**, **64**  
 Exposure mode **49**  
 Extension 90  
 Extracting still pictures **97**, 25  
 Eye-Fi upload **106**, 80  
 Eyelet for camera strap **6**

**F**

Face detection **80**  
 Face priority **69**, 40  
 Fast motion movies **95**, 51  
 Features not available in combination **75**  
 File name 90  
 Fill flash **57**  
 Filter effects **84**, 14, 28  
 Fireworks show 42  
 Firmware version **106**, 84  
 Flash **56**  
 Flash exp. comp. **69**, 45  
 Flash mode **55**, **56**  
 Fn button **71**  
 Focal length **69**, 47, 19  
 Focus **30**, 40, 44, 51

Focus area **30**, 40  
 Focus lock **81**  
 Focus mode **55**, **62**  
 Folder name 91  
 Food 42  
 Format **20**, **105**, 74  
 Format the internal memory **105**, 74  
 Format the memory card **20**, **105**, 74  
 FSCN 90  
 Full-frame playback **32**  
 Full-time AF **69**, **96**, 44, 51

**G**

GPS **98**  
 GPS options **101**, 59  
 GPS options menu **101**, 59

**H**

HDMI **87**, **105**, 17, 75  
 HDMI 3D output 75  
 HDMI device control 75  
 HDMI mini connector **87**, 17  
 HDR **38**  
 High-speed continuous **68**, 34  
 HS movie **95**, 49, 51

**I**

Identifier 90  
 Image copy **85**, 57  
 Image quality **72**  
 Image sharpening 28  
 Image size **72**, **73**  
 Infinity **63**  
 Internal memory indicator **22**  
 Interval Timer Shooting **68**, 35, 36  
 ISO sensitivity **69**, 38

**L**

Landscape mode **38**  
 Language **105**, 74  
 Lens 6, 19  
 Lens cap **6**  
 Li-ion rechargeable battery **16**

**M**

Macro close-up **63**

## Index

Manual focus 63, 2  
Manual mode 49, 51  
Memory capacity 22  
Memory card 20, 21  
Memory card slot 20  
Metering 68, 33  
Microphone 92, 56  
Minimum shutter speed 38  
Mode dial 26  
Monitor 7, 9, 12, 6  
Monitor brightness 103, 67  
Monitor settings 103, 67  
Motion detection 104, 70  
Movie length 92, 50  
Movie menu 96, 48  
Movie options 96, 48  
Movie playback 97  
Movie recording 92  
Multi selector 3, 5, 49, 55  
Multi-shot 16 68, 35  
Museum 42

## N

Night landscape mode 37  
Night portrait 40  
Noise reduction filter 69, 45  
Number of exposures remaining 22, 74

## O

Optical zoom 29  
Optional accessories 92

## P

Panorama assist 43, 6  
Panorama 43  
Paper size 23  
Party/indoor 40  
Pet portrait 44  
Photo info 103  
PictBridge 87, 19, 22  
Picture Control 68, 26  
Playback 32, 97, 56  
Playback menu 84, 52  
Playback mode 32  
Playback zoom 82

Points of Interest (POI) 100, 101, 60  
Portrait 39  
Power 22, 23, 24  
Power switch/power-on lamp 23  
Preset manual 32  
Pre-shooting cache 68, 34, 36  
Pressing halfway 3, 30  
Print 19, 20, 21  
Print date 103, 68  
Print order 84, 52  
Print order date option 53  
Printer 87, 19  
Programmed auto mode 49, 51  
Protect 84, 55

## Q

Quick adjust 28  
Quick retouch 84, 12

## R

Rear-curtain sync 57  
Rechargeable battery 16, 92  
Record GPS data 98  
Recording slow motion movies 95, 51  
Reset all 106, 81  
Reset file numbering 105, 78  
Reset user settings 54, 69  
Reverse indicators 106, 80  
Rotary multi selector 3, 5, 49, 55  
Rotate image 84, 55  
RSCN 90

## S

Saturation 28  
Save user setting 53, 69  
Scene auto selector 39  
Scene mode 36  
Selecting pictures 86  
Self-timer 55, 59  
Self-timer lamp 59  
Sequence 32, 8  
Sequence display options 85, 58  
Setup menu 103, 64  
Shooting 26  
Shooting date information 9, 12

Shooting menu 67, 26  
Shooting mode 27  
Shutter sound 104, 73  
Shutter speed 49, 78  
Shutter-priority auto mode 49, 51  
Shutter-release button 3, 5, 30  
Single 68, 34  
Single AF 69, 96, 44, 51  
Skin softening 46, 84, 13  
Slide show 84, 54  
Slow sync 57  
Small picture 84, 15  
Smile timer 55, 60  
Snow 40  
Sound settings 104, 73  
Special effects mode 47  
Sports 40  
SSCN 90  
Startup zoom position 69, 47  
Sub-command dial 49  
Subject tracking 69, 41, 43  
Sunset 41  
Switching between tabs 11  
Synchronize 102, 63

**I**

Target finding AF 69, 79, 42  
Tele 29  
Thumbnail playback 83  
Time difference 66  
Time zone 24, 66  
Time zone and date 24, 103, 65  
Toggle Av/Tv selection 105, 78  
Tone level 15  
Tone level information 9, 15, 67  
Toning 29  
TV settings 105, 75

**U**

USB cable 87, 90, 19  
USB/Audio video connector 87, 90, 17, 19  
User setting modes 53

**V**

Vibration reduction 104, 69  
Video mode 105, 75  
View grid 27  
View log 102, 63  
View/hide framing grid 12, 103, 67  
View/hide histograms 15, 103, 67  
Viewfinder 8  
ViewNX 2 88  
Voice memo 85, 56  
Volume 97

**W**

Welcome screen 103, 64  
White balance 68, 31  
Wide 29

**Z**

Zoom 29  
Zoom control 3, 4, 29  
Zoom memory 69, 47

No reproduction in any form of this manual, in whole or in part (except for brief quotation in critical articles or reviews), may be made without written authorization from NIKON CORPORATION.