

Nikon

En

The Nikon Guide to Digital Photography
with the

D I G I T A L C A M E R A

COOLPIX L5



CE

Trademark Information

Macintosh, Mac OS, and QuickTime are registered trademarks of Apple Computer, Inc. Microsoft and Windows are registered trademarks of Microsoft Corporation.

The SD logo is a trademark of the SD Card Association. Adobe and Acrobat are registered trademarks of Adobe Systems Inc. PictBridge is a trademark. D-Lighting technology is provided by  Apical Limited. Face-priority AF technology is provided by Identix[®]. All other trade names mentioned in this manual or the other documentation provided with your Nikon product are trademarks or registered trademarks of their respective holders.

Introduction

Preparation for Shooting

**Basic Photography and
Playback: 📷 (Auto) Mode**

**Selecting Scene Mode:
SCENE Scene Mode**

One-Touch Portrait Mode

More on Playback

Recording and Viewing Movies

**Connecting to Televisions,
Computers, and Printers**

**Shooting, Playback, and Setup
Menus**

Technical Notes

For Your Safety

To prevent damage to your Nikon product or injury to yourself or to others, read the following safety precautions in their entirety before using this equipment. Keep these safety instructions where all those who use the product will read them.

The consequences that could result from failure to observe the precautions listed in this section are indicated by the following symbol:



This icon marks warnings, information that should be read before using this Nikon product to prevent possible injury.

WARNINGS

Turn off in the event of malfunction

Should you notice smoke or an unusual smell coming from the camera or AC adapter, unplug the AC adapter and remove the batteries immediately, taking care to avoid burns. Continued operation could result in injury. After removing or disconnecting the power source, take the equipment to a Nikon-authorized service representative for inspection.

Do not disassemble

Touching the product's internal parts could result in injury. Repairs should be performed only by qualified technicians. Should the camera break open as the result of a fall or other accident, take the product to a Nikon-authorized service representative for inspection after unplugging the product and/or removing the batteries.

Do not use the camera or AC adapter in the presence of flammable gas

Do not use electronic equipment in the presence of flammable gas, as this could result in explosion or fire.

Handle the camera strap with care

Never place the strap around the neck of an infant or child.

Keep out of reach of children

Particular care should be taken to prevent infants from putting the batteries or other small parts into their mouths.

Observe caution when handling batteries

Batteries may leak or explode if improperly handled. Observe the following precautions when handling batteries for use in this product:

- Before replacing the batteries, turn the product off. If you are using an AC adapter, be sure it is unplugged.
- Use only the batteries approved for use in this product (ⓧ 12). Do not use other types. Do not mix old and new batteries or batteries of different makes or types.
- Charge and use each pair of Nikon rechargeable EN-MH1 NiMH batteries as a set. Do not mix batteries from different pairs.
- Insert batteries in the correct orientation.
- Do not short or disassemble batteries or attempt to remove or break battery insulation or casing.
- Do not expose batteries to flame or to excessive heat.
- Do not immerse in or expose to water.
- Do not transport or store with metal objects such as necklaces or hairpins.
- Batteries are prone to leakage when fully discharged. To avoid damage to the product, be sure to remove the batteries when no charge remains.
- Discontinue use immediately should you notice any change in

the batteries, such as discoloration or deformation.

- If liquid from damaged batteries comes in contact with clothing or skin, rinse immediately with plenty of water.

Observe the following precautions when handling the battery charger

If an MH-71 battery charger was provided with the camera, observe the following precautions:

- Keep dry. Failure to observe this precaution could result in fire or electric shock.
- Dust on or near the metal parts of the plug should be removed with a dry cloth. Continued use could result in fire.
- Do not handle the power cable or go near the battery charger during lightening storms. Failure to observe this precaution could result in electric shock.
- Do not damage, modify, forcibly tug or bend the power cable, place it under heavy objects, or expose it to heat or flame. Should the insulation be damaged and the wires become exposed, take it to a Nikon-authorized service representative for inspection. Failure to observe these precautions could result in fire or electric shock.

For Your Safety

- Do not handle the plug or battery charger with wet hands. Failure to observe this precaution could result in electric shock.

Use appropriate cables

When connecting cables to the input and output jacks, use only the cables provided or sold by Nikon for the purpose, to maintain compliance with product regulations.

Handle moving parts with care

Be careful that your fingers or other objects are not pinched by the lens cover or other moving parts.

CD-ROMs

The CD-ROMs supplied with this device should not be played back on audio CD equipment. Playing CD-ROMs on an audio CD player could cause hearing loss or damage the equipment.

Observe caution when using the flash

Using the flash close to your subject's eyes could cause temporary visual impairment. Particular care should be observed if photographing infants, when the flash should be no less than one meter (39 in.) from the subject.

Do not operate the flash with the flash window touching a person or object

Failure to observe this precaution could result in burns or fire.

Avoid contact with liquid crystal

Should the monitor break, care should be taken to avoid injury caused by broken glass and to prevent liquid crystal from the monitor touching the skin or entering the eyes or mouth.

Notices

Notice for Customers in the U.S.A.

Federal Communications Commission (FCC) Radio Frequency Interference Statement

This equipment has been tested and found to comply with the limits for a Class B digital device, pursuant to Part 15 of the FCC rules. These limits are designed to provide reasonable protection against harmful interference in a residential installation. This equipment generates, uses, and can radiate radio frequency energy and, if not installed and used in accordance with the instructions, may cause harmful interference to radio communications. However, there is no guarantee that interference will not occur in a particular installation. If this equipment does cause harmful interference to radio or television reception, which can be determined by turning the equipment off and on, the user is encouraged to try to correct the interference by one or more of the following measures:

- Reorient or relocate the receiving antenna.
- Increase the separation between the equipment and receiver.
- Connect the equipment into an outlet on a circuit different from that to which the receiver is connected.

- Consult the dealer or an experienced radio/television technician for help.



CAUTIONS

Modifications

The FCC requires the user to be notified that any changes or modifications made to this device that are not expressly approved by Nikon Corporation may void the user's authority to operate the equipment.

Interface Cables

Use the interface cables sold or provided by Nikon for your equipment. Using other interface cables may exceed the limits of Class B Part 15 of the FCC rules.

Notice for customers in the State of California

WARNING: Handling the cord on this product will expose you to lead, a chemical known to the State of California to cause birth defects or other reproductive harm. *Wash hands after handling.*

Nikon Inc.,
1300 Walt Whitman Road
Melville, New York 11747-3064 USA
Tel: 631-547-4200

Notice for Customers in Canada

CAUTION

This class B digital apparatus meets all requirements of the Canadian Interference Causing Equipment Regulations.

ATTENTION

Cet appareil numérique de la classe B respecte toutes les exigences du Règlement sur le matériel brouilleur du Canada.

Symbol for Separate Collection in European Countries



This symbol indicates that this product is to be collected separately.



The following apply only to users in European countries:

- This product is designated for separate collection at an appropriate collection point. Do not dispose of as household waste.
- For more information, contact the retailer or the local authorities in charge of waste management.

Table of Contents

Introduction	ii
For Your Safety	ii
WARNINGS	ii
Notices	v
About This Manual	1
Information and Precautions	2
Parts of the Camera	4
The Monitor	6
Shooting	6
Playback	7
Basic Operations/Displaying the Help	8
Mode Selector	8
Multi Selector	8
MENU Button	9
Help Displays	9
Preparation for Shooting	10
Inserting Batteries	10
Charge the Batteries (EN-MH1 batteries only)	10
Insert the Batteries	12
Supported Batteries	12
Turning On and Off the Camera	12
Setting Display Language, Date, and Time	14
Inserting Memory Cards	16
Removing Memory Cards	17
Basic Photography and Playback:  (Auto) Mode	18
Step1 Select  (Auto) Mode and Turn the Camera On	18
Step2 Frame a Picture	20
Step3 Focus and Shoot	22
Step4 Viewing/Deleting Pictures	24
Viewing Pictures: Full-Frame Playback	24
Deleting Pictures	24
Using the Flash	26
Taking Pictures with the Self-Timer	28
Macro Close-up Mode	29
Exposure Compensation	30

Selecting Scene Mode: SCENE Scene Mode.....	31
Scene Mode	31
Scene Assist Modes.....	32
Scene Modes.....	37
One-Touch Portrait Mode.....	44
Taking Pictures in the One-Touch Portrait Mode.....	44
The One-Touch Portrait Menu.....	46
Applying Portrait Effect	46
More on Playback	47
Viewing Multiple Pictures: Thumbnail Playback	47
Taking a Closer Look: Playback Zoom.....	48
Editing Pictures.....	49
Creating a Cropped Copy: Crop.....	49
Enhancing Contrast: D-Lighting.....	50
 Resizing Pictures: Small Picture.....	51
Restrictions on Picture Editing.....	52
Voice Memos: Recording and Playback	53
Recording Voice Memos.....	53
Playing Voice Memos	53
Deleting Voice Memos	53
Recording and Viewing Movies.....	54
Movie Mode.....	54
The Movie Menu	55
Movie Options.....	55
Auto-Focus Mode.....	55
Applying Movie Setting	56
Movie Playback.....	57
Deleting Movie Files	57
Connecting to Televisions, Computers, and Printers	58
Connecting to a TV.....	59
Connecting to a Computer	60
Before Connecting the Camera	60
Setting the USB Option	61
Transferring Pictures to a Computer	62

Connecting to a Printer.....	64
Connecting the Camera and Printer	65
Printing Pictures One at a Time.....	66
Printing Multiple Pictures.....	67
Creating a DPOF Print Order: Print Set	70
<hr/>	
Shooting, Playback, and Setup Menus.....	72
Shooting Options: The Shooting Menu	72
Image Mode	73
White Balance	75
Metering.....	77
Continuous.....	78
BSS	79
Color Options.....	79
AF Area Mode	80
Restrictions on Camera Settings	81
Playback Options: The Playback Menu	82
Slide Show	84
Delete	85
Protect	85
Transfer Marking	86
Copy.....	87
Basic Camera Setup: The Setup Menu.....	88
Menus.....	89
Welcome Screen	90
Date	91
Monitor Settings.....	94
Date Imprint.....	95
Sound Settings.....	97
Auto Off	97
Format Memory/Format Card	98
Language	99
Interface.....	99
Reset All.....	100
Battery Type	102
Firmware Version	102

Technical Notes	103
Optional Accessories	103
Image File and Folder Names	104
Caring for the Camera	105
Cleaning	106
Storage	107
Error Messages.....	108
Troubleshooting.....	111
Specifications.....	115
Index.....	118

About This Manual

Thank you for your purchase of a Nikon COOLPIX L5 digital camera. This manual has been written to help you enjoy taking pictures with your Nikon digital camera. Read this manual thoroughly before use, and keep it where all those who use the product will read it.

Symbols and Conventions

To make it easier to find the information you need, the following symbols and conventions are used:



This icon marks cautions, information that should be read before use to prevent damage to the camera.



This icon marks tips, additional information that may be helpful when using the camera.



This icon marks notes, information that should be read before using the camera.



This icon indicates that more information is available elsewhere in this manual or in the *Quick Start Guide*.

Notations

- A Secure Digital (SD) memory card is referred to as a “memory card.”
- The setting at the time of purchase is referred to as the “default setting.”
- The names of the menu items displayed in the camera monitor, and the names of the buttons or messages displayed in the computer monitor are indicated with brackets ([]).

Screen Samples

In this manual, images are sometimes omitted from monitor display samples so that monitor icons can be more clearly shown.

Illustrations and Screen Display

Illustrations and text displays shown in this manual may differ from actual display.

Memory Cards

Pictures taken with this camera can be stored in the camera’s internal memory or on removable memory cards. If a memory card is inserted, all new pictures will be stored on the memory card and delete, playback, and format operations will apply only to the pictures on the memory card. The memory card must be removed before the internal memory can be formatted or used to store, delete, or view pictures.

Information and Precautions

Life-Long Learning

As part of Nikon's "Life-Long Learning" commitment to ongoing product support and education, continually updated information is available online at the following sites:

- For users in the U.S.A.: <http://www.nikonusa.com/>
- For users in Europe and Africa: <http://www.europe-nikon.com/support>
- For users in Asia, Oceania, and the Middle East: <http://www.nikon-asia.com/>

Visit these sites to keep up-to-date with the latest product information, tips, answers to frequently asked questions (FAQs), and general advice on digital imaging and photography. Additional information may be available from the Nikon representative in your area. See the URL below for contact information:

<http://nikonimaging.com/>

Use Only Nikon Brand Electronic Accessories

Nikon COOLPIX cameras are designed to the highest standards and include complex electronic circuitry. Only Nikon brand electronic accessories (including battery chargers, batteries, and AC adapters) certified by Nikon specifically for use with this Nikon digital camera are engineered and proven to operate within the operational and safety requirements of this electronic circuitry.

THE USE OF NON-NIKON ELECTRONIC ACCESSORIES COULD DAMAGE THE CAMERA AND MAY VOID YOUR NIKON WARRANTY.

For more information about Nikon brand accessories, contact a local authorized Nikon dealer.

Before Taking Important Pictures

Before taking pictures on important occasions (such as at weddings or before taking the camera on a trip), take a test shot to ensure that the camera is functioning normally. Nikon will not be held liable for damages or lost profits that may result from product malfunction.

About Manuals

- No part of the manuals included with this product may be reproduced, transmitted, transcribed, stored in a retrieval system, or translated into any language in any form, by any means, without Nikon's prior written permission.
- Nikon reserves the right to change the specifications of the hardware and software described in these manuals at any time and without prior notice.
- Nikon will not be held liable for any damages resulting from the use of this product.
- While every effort has been made to ensure that the information in these manuals is accurate and complete, we would appreciate it were you to bring any errors or omissions to the attention of the Nikon representative in your area (address provided separately).

Notice Concerning Prohibition of Copying or Reproduction

Note that simply being in possession of material that has been digitally copied or reproduced by means of a scanner, digital camera or other device may be punishable by law.

- **Items prohibited by law from being copied or reproduced**

Do not copy or reproduce paper money, coins, securities, government bonds, or local government bonds, even if such copies or reproductions are stamped "Sample."

The copying or reproduction of paper money, coins, or securities which are circulated in a foreign country is prohibited.

Unless the prior permission of the government has been obtained, the copying or reproduction of unused postage stamps or post cards issued by the government is prohibited.

The copying or reproduction of stamps issued by the government and of certified documents stipulated by law is prohibited.

- **Cautions on certain copies and reproductions**

The government has issued cautions on copies or reproductions of securities issued by private companies (shares, bills, checks, gift certificates, etc.), commuter passes, or coupon tickets, except when a minimum of necessary copies are to be provided for business use by a company. Also, do not copy or reproduce passports issued by the government, licenses issued by public agencies and private groups, ID cards, and tickets, such as passes and meal coupons.

- **Comply with copyright notices**

The copying or reproduction of copyrighted creative works such as books, music, paintings, woodcut prints, maps, drawings, movies, and photographs is governed by national and international copyright laws. Do not use this product for the purpose of making illegal copies or to infringe copyright laws.

Disposing of Data Storage Devices

Please note that deleting images or formatting data storage devices such as memory cards or built-in camera memory does not completely erase the original image data. Deleted files can sometimes be recovered from discarded storage devices using commercially available software, potentially resulting in the malicious use of personal image data. Ensuring the privacy of such data is the user's responsibility.

Before discarding a data storage device or transferring ownership to another person, erase all data using commercial deletion software, or format the device and then completely refill it with images containing no private information (for example, pictures of empty sky). Be sure to also replace any pictures selected for the welcome screen (📷 90). Care should be taken to avoid injury or damage to property when physically destroying data storage devices.

Parts of the Camera

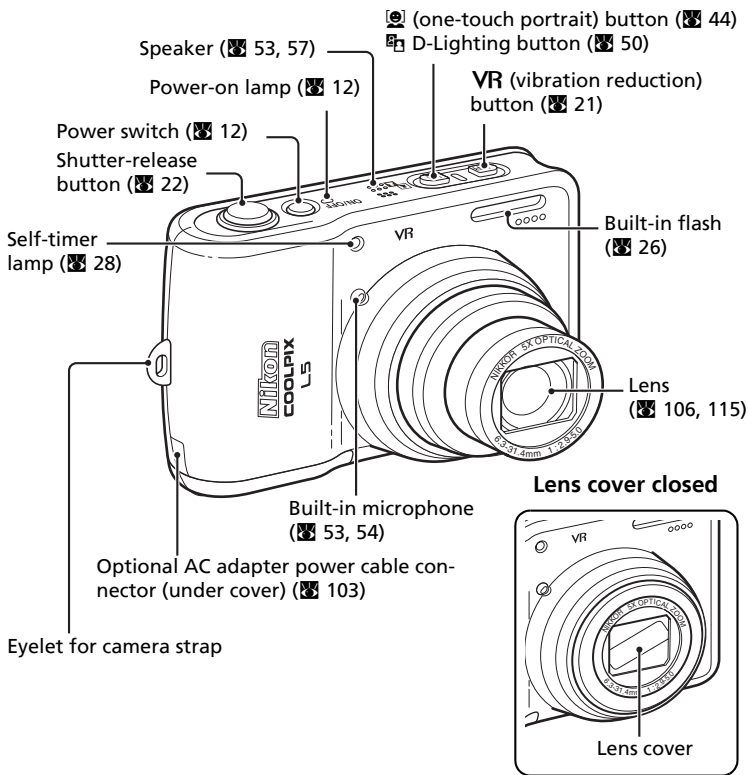

Attaching the Camera Strap

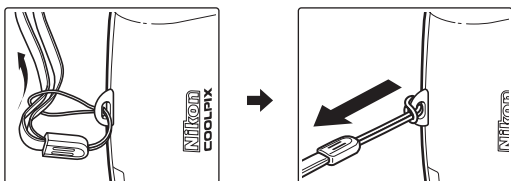

Mode selector
(☒ 8, 18, 31, 54)

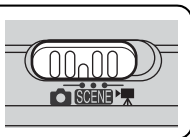

Zoom buttons (☒ 20)

W : Zoom out

T : Zoom in

See also:

- (thumbnail playback): ☒ 47
- (playback zoom): ☒ 48
- (help): ☒ 9

Flash lamp (☒ 27)

Monitor (☒ 6)

MENU button (☒ 9)

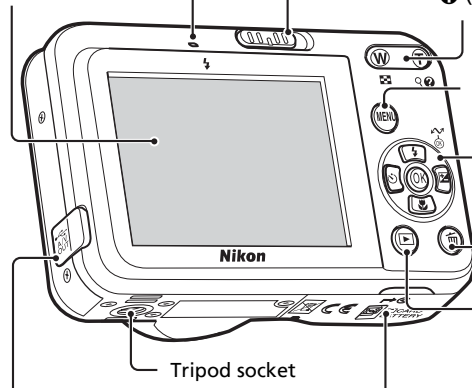

(delete) button
(☒ 24, 53, 57)

(playback) button
(☒ 24, 47)

Tripod socket

Connector cover (☒ 59, 60, 65)

Battery-chamber cover (☒ 12)

Opening the connector cover

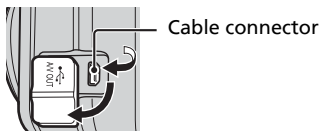

Memory card slot (☒ 16)

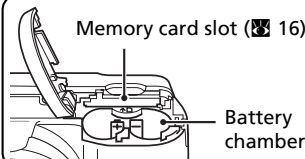

Battery chamber

Multi selector (☒ 8)

: Display self-timer menu (☒ 28)

: Display macro close-up mode menu (☒ 29)

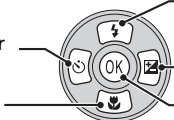

: Display flash mode menu (☒ 26)

: Adjust the exposure setting (☒ 30)

: Make selection/transfer picture (☒ 60)

The Monitor

The following indicators may appear in the monitor during shooting and playback (actual display varies with current camera settings).

Shooting

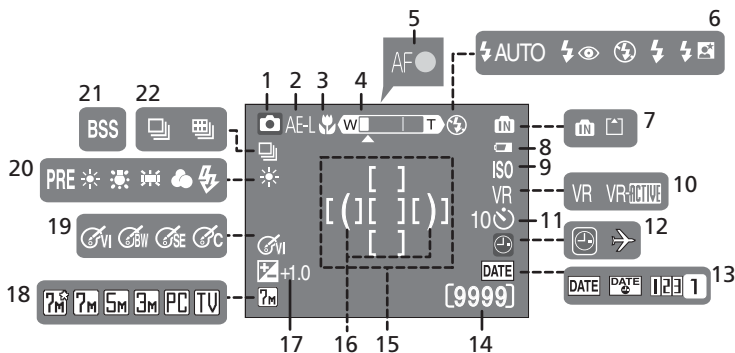

1	Shooting mode* 18, 31, 44, 54
2	Exposure lock 43
3	Macro close-up mode..... 29
4	Zoom indicator 20, 29
5	Focus indicator 22
6	Flash mode 26
7	Internal memory/memory card indicator 19
8	Battery level indicator 18
9	ISO sensitivity 27
10	Vibration reduction (VR) icon..... 21
11	Self-timer indicator 28
12	"Date not set" indicator..... 108
	Time zone indicator..... 91

13	Date imprint/Date counter 95
14	Number of exposures remaining 18
	Movie length 54
15	Focus area 22, 80
16	Reference circle for center-weighted metering 77
17	Exposure compensation value..... 30
18	Image mode 73
19	Color options setting 79
20	White balance 75
21	Best shot selector (BSS)..... 79
22	Continuous shooting mode 78

* Differs according to the current shooting mode. See each page for the monitor indicators.

Playback

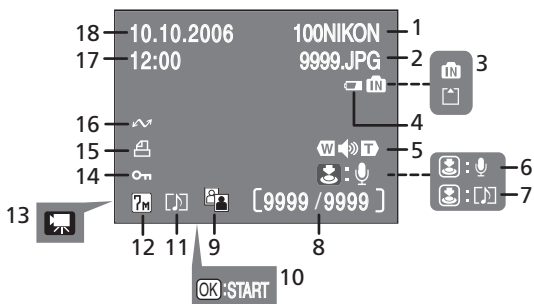

1	Current folder	104	9	D-Lighting icon	50
2	File number and type	104	10	Movie playback indicator	57
3	Internal memory/ memory card indicator	19	11	Voice memo icon	53
4	Battery level indicator	18	12	Image mode	73
5	Volume indicator	53, 57	13	Movie indicator	57
6	Voice memo recording guide	53	14	Protect icon	85
7	Voice memo playback guide	53	15	Print-order icon	70
8	Current frame number/ total number of frames/ movie length	24 57	16	Transfer icon	63, 86
			17	Time of recording	14
			18	Date of recording	14

Basic Operations/Displaying the Help

Mode Selector

Set the mode selector to the desired mode.

: Auto mode (📷 18)
A simple “point-and-shoot” mode in which the majority of camera settings are controlled by the camera.

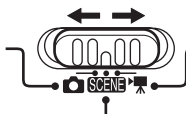

: Scene mode (📷 31)
Select one of fifteen “scenes” suited to different subjects of shooting conditions, such as indoor parties or night landscapes, and let the camera do the rest.

: Movie mode (📷 54)
Record movies. Select one of three movie options.

Multi Selector

In addition to activating the flash, macro close-up, self-timer, and exposure compensation modes and functions, the multi selector is also used to perform the following operations.

Full-Frame Playback

Display the previous picture (📷 24).
(◀ or ▲)

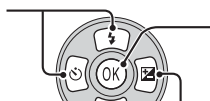

Quick playback zoom (📷 48)

Display the next picture (📷 24).
(▶ or ▼)

Navigating the Menus

Return to the previous menu, or move cursor left (◀).

Move cursor down (▼).

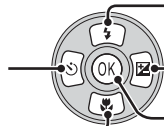

Move cursor up (▲).











Display the sub-menu, move cursor right, or make selection (▶).

Make selection.

* In the manual, the multi selector buttons for moving the cursor or selection up, down, left, and right are indicated with ▲, ▼, ◀ and ▶.

MENU Button

When **MENU** is pressed, the following menus are displayed according to the mode which has been selected.

	: Auto mode	→	Shooting menu ( 72)
	: Scene mode	→	Scene menu ( 31)
	: Movie mode	→	Movie menu ( 54)
	: One-touch portrait mode	→	One-touch portrait menu ( 46)
	: Playback mode	→	Playback menu ( 82)

To display the setup menu ( 88), choose [Set up] at the top of all menus.

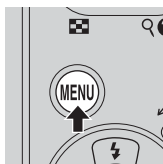

Displayed when there are one or more previous menu items.

Displayed when there are one or more menu items to follow.

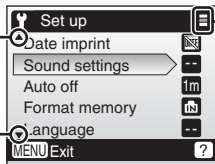



Displayed when the menu contains two or more pages.

Help Displays

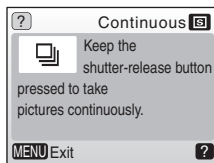
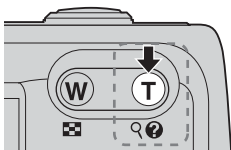
Press  (**T**) to view a description of the currently selected item.



Pressing  or  shows the previous or next menu item. Press  while the help dialog is displayed to apply the setting.

Inserting Batteries

The camera uses two AA batteries. Depending on the country or region of purchase, either two alkaline batteries or two EN-MH1 rechargeable batteries with an MH-71 battery charger are included with purchase of the camera.

Charge the Batteries (EN-MH1 batteries only)

If the camera came with Nikon EN-MH1 rechargeable NiMH batteries and a battery charger, charge the batteries as described below. If the camera came with alkaline batteries, skip to “Insert the Batteries” on the following page.

1 Plug in the charger.

- Connect the power cable to the charger (①) and plug into a power outlet (②). The CHARGE lamp will light (③).

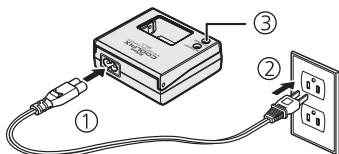

2 Charge the batteries.

- Insert the batteries as indicated on the charger. The CHARGE lamp will begin blinking. Charging is complete when the CHARGE lamp stops blinking. A pair of new or fully exhausted batteries will charge in about two and a half hours.

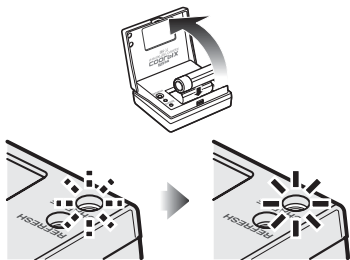

Battery charger recharging state and recommendations

CHARGE lamp	Batteries	Description
Glows	Not inserted	Charger plugged in: insert the batteries.
Blinks	Inserted	Batteries recharging
Glows	Inserted	Charging is complete (batteries are fully charged): remove batteries from the charger.
Flickers	Inserted	Temperature is outside designated range: use charger inside designated temperature range. Batteries have malfunctioned: stop charging immediately and unplug the charger.*

* Take the charger and batteries to your retailer or local Nikon representative.

- 3 Remove the batteries and unplug the charger from the power outlet.

EN-MH1 Batteries

Charge EN-MH1 batteries before using them for the first time. Charge and use as a set: do not charge batteries one at a time or combine batteries from different pairs. Note that the batteries may tend to discharge more quickly when new or after a long period of disuse. The batteries will retain their charge longer once they have been exhausted and recharged several times. “Memory” effects that result in reduced battery capacity can be avoided by periodically refreshing the batteries.

Refreshing Nikon EN-MH1 Rechargeable NiMH Batteries

Two EN-MH1 rechargeable NiMH batteries and an MH-71 battery charger are provided with the camera in some regions and are also available separately (see 103). NiMH batteries may suffer a temporary drop in capacity if charged after long periods of disuse or before being fully discharged. They will return to normal after being refreshed a few times as described below.

- 1 Insert both batteries into the charger.
- 2 Press the REFRESH button until the REFRESH lamp lights and close the lid. The REFRESH lamp turns off when the batteries are fully discharged. The batteries can now be removed or left in the MH-71 to recharge. Unplug the charger after removing the batteries. To resume charging before the batteries are fully discharged, or to refresh the batteries once charging has begun, press the REFRESH button for about two seconds.

Batteries that retain a charge for only short periods after being refreshed have reached the end of their working lives and can no longer be used.

Insert the Batteries

- 1 Open the battery-chamber cover.
 - Hold the camera upside down to prevent the batteries from falling out.

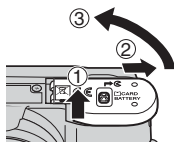

- 2 Insert the batteries.
 - Insert the batteries correctly as shown at right.

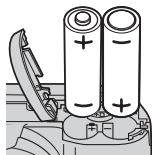

- 3 Close the battery-chamber cover.

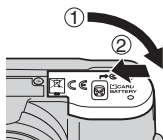

Supported Batteries

This camera uses the following size AA batteries.

- Two LR6 alkaline batteries (batteries supplied)
- Two Nikon EN-MH1 rechargeable nickel-metal hydride batteries (NiMH)
- Two ZR6 oxyride batteries
- Two FR6/L91 lithium batteries

Turning On and Off the Camera

To turn on the camera, press the power switch. The power-on lamp (green) will light and the monitor will turn on.

To turn off the camera, press the power switch again.

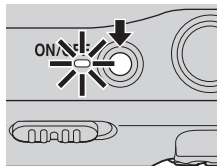

✓ Replacing Batteries

Turn the camera off and make sure that the power-on lamp has gone out before removing or inserting batteries.

✓ Additional Precautions Regarding Batteries

- Read and follow the warnings and cautions on pages iii-iv and 106 of this manual.
- Do not combine old and new batteries or batteries of different makes or types.
- Batteries with the following defects cannot be used:

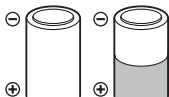

Batteries with peeling



Batteries with insulation that does not cover the area around the negative terminal.

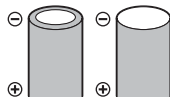

Batteries with a flat negative terminal

✓ Battery Type

To improve battery performance, select the type of battery currently inserted in the camera in the setup menu. The default setting is the type of battery supplied with purchase. If your camera was purchased in Europe and alkaline batteries were supplied, change the setting to [Alkaline]. When any other type of battery is used, turn the camera on and change the setting (ⓧ 102).

✎ Alkaline Batteries

Performance of alkaline batteries may vary greatly depending on the manufacturer. Choose a reliable brand.

✎ Alternative Power Resources

To power the camera continuously for extended periods, use an EH-65A AC adapter (ⓧ 103). **Do not, under any circumstances, use another make or model of AC adapter.** Failure to observe this precaution could result in overheating or in damage to the camera.

✎ Power Saving Function in Shooting Mode

To reduce the drain on the batteries, the brightness of the monitor will be reduced to about 50% normal brightness after approximately five seconds pass without any operation while the power is on. After a preset time passes, the Auto off function (automatically turning the power off) works as follows.

Approx. one minute (default setting): The monitor turns off and the camera enters standby mode. The power-on lamp blinks.

The camera will be reactivated from standby mode when you press the shutter-release button halfway.

The length of time before the camera enters the standby mode can be specified from the auto off menu (ⓧ 97).

Approx. three minutes after the camera has entered standby mode: The camera will turn off.

Setting Display Language, Date, and Time

A language-selection dialog is displayed the first time the camera is turned on.

1 Turn on the camera.

- The power-on lamp (green) will light and the monitor will turn on.

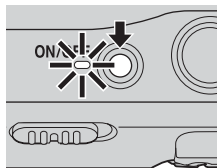

2 Press the multi selector ▲, ▼, ◀ or ▶ to choose the desired language and press **OK**.

- For information on using the multi selector, see "Multi Selector" (8 8).



3 Press ▲ or ▼ to choose [Yes] and press **OK**.

- If [No] is selected, the date and time will not be set.

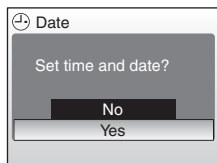

4 Press ▶.

- The [Home time zone] menu is displayed.
- If daylight saving time is in effect, see "Daylight Saving Time" on the next page.

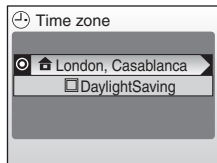

5 Press ◀ or ▶ to choose your home time zone and press **OK**.

- The [Date] menu is displayed.



- 6** Press ▲ or ▼ to edit the day ([D]) (order of the day, month, and year may differ in some areas) and press ►.

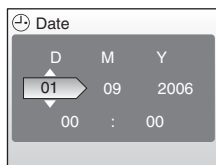

- 7** Press ▲ or ▼ to edit the month ([M]) and press ►.

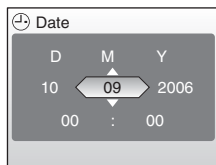

- 8** Press ▲ or ▼ to edit the year ([Y]), hour, and minutes. Press ► after setting each item.

- [D], [M], and [Y] blink.

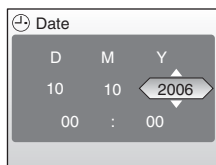

- 9** Choose the order in which the day, month, and year are displayed and press OK.

- The settings are applied and monitor display returns to the standard display for the current mode.

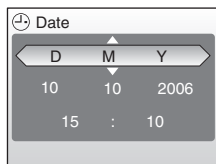

☑ Daylight Saving Time

If daylight saving time is in effect, turn on [DaylightSaving] in the time zone menu in step 4 and set the date.

- 1 Press the multi selector ▼ to choose [DaylightSaving].
- 2 Press OK to enable daylight saving time (✓).
 - The OK button toggles the daylight saving time option on and off.
- 3 Press ▲ and then ► and proceed to step 5.

When daylight saving time ends, turn [DaylightSaving] off from the [Date] menu (F8 91) in the setup menu (F8 88). The camera's clock is automatically set back one hour.

Inserting Memory Cards

Pictures are stored in the camera's internal memory (8 MB) or on removable Secure Digital (SD) memory cards (available separately) (📷 103).

If a memory card is inserted in the camera, pictures are automatically stored on the memory card and only pictures recorded to the memory card can be played back, deleted, or transferred. Remove the memory card to store pictures in the internal memory, or play back, delete, or transfer pictures from the internal memory.

1 Turn the camera off, and open the battery-chamber cover.

- Make sure that the camera is off (power-on lamp is off) before opening the battery-chamber cover.
- Hold the camera upside down to prevent the batteries from falling out.

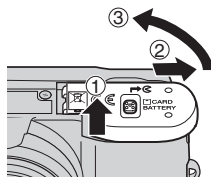

2 Insert the memory card.

- Slide the memory card in as shown until it clicks into place.
- Close the battery-chamber cover.

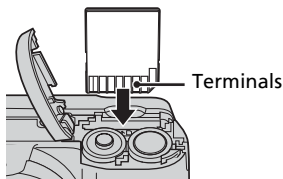

❌ Inserting Memory Cards

Inserting the memory card upside down or backwards could damage the camera or the memory card. Be sure that the memory card is correctly oriented when inserting.

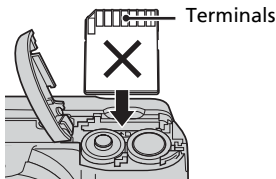
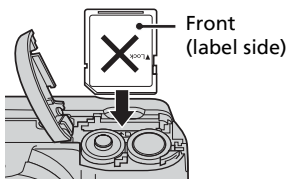

Removing Memory Cards

Turn the camera off and make sure that the power-on lamp is off before opening the battery-chamber cover. Press the memory card lightly (①) to release it. Once released, pull the memory card out carefully (②).

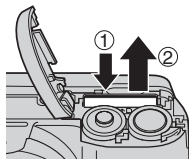

✔ Formatting Memory Cards

If the message at right is displayed when the power is on, the memory card must be formatted (☒ 98) before use.

Note that **formatting permanently deletes all pictures** and other data on the memory card. Be sure to make copies of any pictures you wish to keep before beginning formatting.

To begin formatting, press the multi selector ▲ or ▼ to choose [Format] and then press ☒.

Do not turn the camera off or remove the batteries or memory card until formatting is complete.

The first time you insert the memory cards used in other devices into the COOLPIX L5, be sure to format them with [Format] (☒ 98).

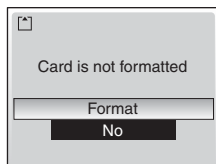

✔ The Write Protect Switch

SD memory cards are equipped with a write protect switch. Pictures cannot be recorded or deleted and the memory card cannot be formatted when this switch is in the "Lock" position.

Write protect switch

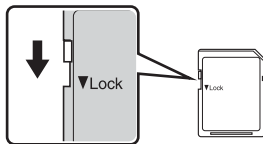

✔ Memory Cards

- Use only Secure Digital (SD) memory cards.
- Do not eject the memory card, turn the camera off, remove the batteries, or disconnect the AC adapter during formatting or while data are being written to or deleted from the memory card.

Failure to observe this precaution could result in loss of data or damage to the camera or memory card.

- Do not disassemble or modify.
- Do not drop, bend, or expose to water or strong physical shock.
- Do not touch the metal terminals with your fingers or metal objects.
- Do not affix labels or stickers to the memory card.
- Do not leave in direct sunlight, closed vehicles, or areas exposed to high temperatures.
- Do not expose to humidity or to corrosive gases.

Step1 Select 📷 (Auto) Mode and Turn the Camera On

This section describes how to take pictures in 📷 (auto) mode, an automatic, “point-and-shoot” mode recommended for first-time users of digital cameras.

1 Slide the mode selector to 📷.

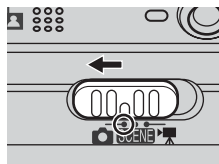

2 Turn the camera on.

- The power-on lamp (green) will light and the monitor will turn on.

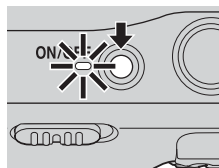

3 Check the battery level and number of exposures remaining.

Battery Level

Monitor	Description
NO ICON	Batteries fully charged.
	Batteries low; ready spare batteries.
Warning!! Battery exhausted 	Batteries exhausted. Replace batteries.

Battery level icon

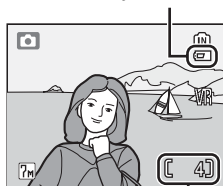

Number of exposures remaining







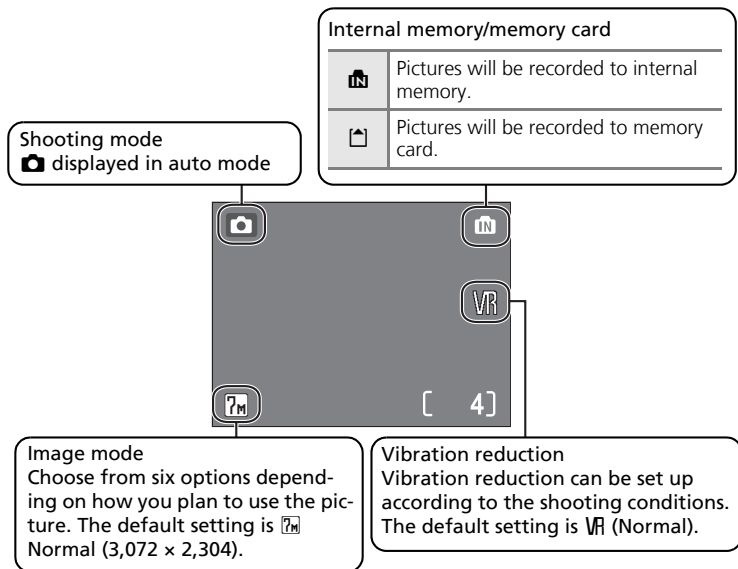





Number of Exposures Remaining

The number of pictures that can be stored depends on the capacity of the internal memory or memory card and option chosen for the image mode setting.

Indicators in (auto) Mode



Available Functions in Auto Shooting Mode

In  mode, macro close-up mode ( 29) and exposure compensation ( 30) can be applied and pictures can be taken using the flash ( 26) and self-timer ( 28). Press **MENU** in  (auto) mode to display the shooting menu. The shooting menu allows you to specify the image mode ( 73), white balance setting ( 75), metering mode ( 77), AF area mode ( 80), and to apply continuous shooting ( 78), BSS ( 79), and color options ( 79) to suit shooting conditions or your own preferences.

Step2 Frame a Picture

1 Ready the camera.

- Hold the camera steadily in both hands, keeping your fingers and other objects away from the lens, flash, and microphone.
- When taking pictures in “tall” orientation, turn the camera clockwise so that the built-in flash is above the lens.

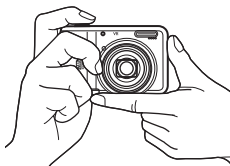

2 Frame the picture.

- Frame the picture with the main subject positioned near the center of the monitor.

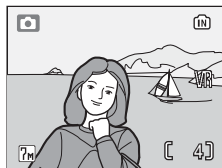

- Press **W** (ZOOM OUT) / **T** (ZOOM IN) to activate optical zoom. Press **W** (ZOOM OUT) to zoom out, increasing the area visible in the frame, or **T** (ZOOM IN) to zoom in so that the subject fills a larger area of the frame.

Zoom out Zoom in

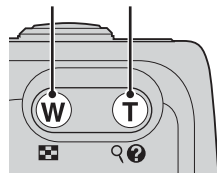

- When the camera is zoomed in to the maximum magnification (5x), holding **T** (ZOOM IN) down for approximately two seconds triggers digital zoom. The subject is magnified up to 4x, for a total magnification of 20x.

A monitor indicator shows the current zoom ratio.



Zoom indicator displayed when **W** (ZOOM OUT) / **T** (ZOOM IN) is pressed



Optical zoom (up to 5x)



Zoom indicator turns yellow when digital zoom is in effect

✔ Digital Zoom

When enlarging a picture with digital zoom, the slightly grainy image might be produced due to digital process.

📷 Vibration reduction (VR)

Vibration reduction effectively corrects blur, caused by slight hand movement known as camera shake, that commonly occurs when shooting with zoom applied or at slow shutter speeds. Press **VR** to enable vibration reduction. The vibration reduction icon is displayed in the monitor.

Vibration reduction can be used in all modes. However, **VR-Active** (active vibration reduction) is not available in movie modes.

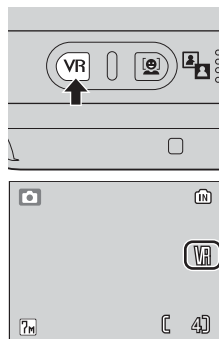

Monitor	Features
VR (Normal) (default setting)	Best choice for most situations. Camera detects and factors out panning movements when reducing camera shake. When camera is panned horizontally, for example, vibration reduction reduces only vertical shake. If camera is panned vertically, vibration reduction affects only horizontal shake.
VR-Active (Active)	Use when shooting from moving vehicles or in other situations in which vibration is exaggerated. Panning not supported.
Off	Vibration reduction is not enabled. Turn vibration reduction off when using a tripod.

- Vibration reduction may take a few seconds to activate after the camera recovers from the standby mode or the power is turned on. Wait until the display stabilizes before shooting.
- There may also be a slight display lag after a picture is taken.
- Vibration reduction may be unable to completely eliminate the effects of camera shake in some situations.

Step3 Focus and Shoot

1 Press the shutter-release button halfway.

- The camera focuses on the subject positioned within the active focus area. By default, the camera automatically chooses the focus area (one of five) containing the subject closest to the camera.

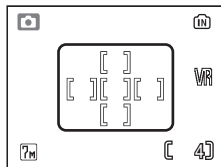

- When the subject is in focus, the focus indicator (AF●) is green. When the camera is unable to focus, the focus indicator blinks red. Change the composition and try again.
- When digital zoom is in effect, the focus area is not displayed.

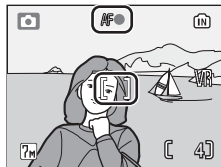



2 Press the shutter release button the rest of the way down to take the picture.

- The shutter will be released, and the picture will be recorded to the memory card or internal memory.
- Note that the flash may fire if the subject is poorly lit.



✔ During Recording

While pictures are being recorded, the  icon will be displayed, or the  or  icon will blink. Do not turn the camera off, eject the memory card, or remove or disconnect the power source while these icons are displayed. Cutting power or removing the memory card in these circumstances could result in loss of data or in damage to the camera or card.

📷 Shutter-Release Button



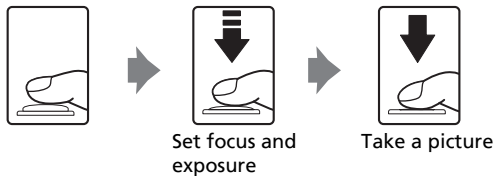

To set focus and exposure, press the shutter-release button halfway, stopping when you feel resistance. Focus and exposure lock while the shutter-release button is held in this position. To release the shutter and take a picture, press the shutter-release button down the rest of the way down. Do not use force when pressing the shutter-release button, as this may result in camera shake and blurred pictures.



Step4 Viewing/Deleting Pictures

Viewing Pictures: Full-Frame Playback

Press .

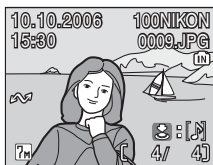

- Press the multi selector  (or ) to view pictures in reverse order,  (or ) to view pictures in the order recorded. Press and hold the multi selector to scroll quickly to a particular frame number without viewing the intervening pictures.
- For information on using the multi selector, see “Multi Selector” (8).
- Pictures may be displayed briefly at low resolution while being read from the memory card or internal memory.
- Press  again to return to the shooting mode.



Deleting Pictures

- 1 Press  to delete the picture currently displayed in the monitor.







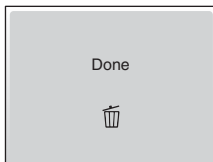
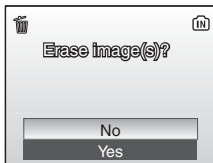

- 2 Press the multi selector  or  to choose [Yes] and press .

- To exit without deleting the picture, choose [No] and press .
- For information on using the multi selector, see “Multi Selector” (8).





Full-Frame Playback Mode

The following functions are available in the full-frame playback mode.

Option	Press	Description	
Quick playback zoom		Enlarge view of picture currently displayed in the monitor about 3x.	48
Enlarge picture	 (T)	Enlarge view of picture currently displayed in the monitor up to about 10x.	48
View thumbnails	 (W)	Display 4, 9, or 16 picture thumbnails.	47
Record/play voice memo		Records/plays voice memos up to 20 seconds in length.	53
D-lighting	 (L)	Enhance brightness and contrast in dark portions of the pictures.	50
View playback menu	MENU	Display the playback menu.	82
Switch to shooting mode		Switch to the shooting mode selected with the mode selector.	24

Quick Playback Zoom



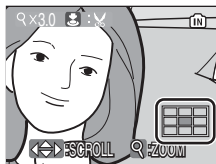

Press  to enlarge the view of the picture currently displayed in full-frame playback 3x. The center of the picture is visible in the monitor ( 48). The enlarged part is displayed in the guide in the lower right corner of the monitor in yellow. Press  to return to full-frame playback.



Viewing Pictures

- When the camera is off, pressing  for about one second will turn the camera on in the full-frame playback mode.
- Pictures stored to the internal memory can only be viewed if no memory card is inserted.

Deleting the Last Picture Taken

In shooting mode, press  to delete the last picture taken. The confirmation dialog shown at right will be displayed. Press the multi selector  or  to choose [Yes] and press .

- To exit without deleting the picture, choose [No] and press .



Using the Flash

The flash menu will help you to set the flash mode best suited the shooting conditions.

The flash has a range of 0.5–5.5 m (1 ft. 7.7 in.–18 ft. 0.5 in.) when the camera is zoomed out all the way. With maximum optical zoom applied, the range is 0.6–4 m (1 ft. 12 in.–13 ft. 1.8 in.). The following flash modes are available:

Auto (default setting in mode)

Flash fires automatically when lighting is poor.

Auto with red-eye reduction

Reduces “red eye” in portraits ( 27).

Off

Flash will not fire even when lighting is poor.

Fill flash

Flash fires whenever picture is taken. Use to “fill-in” (illuminate) shadows and back-lit subjects.

Slow sync





Flash illuminates main subject; slow shutter speeds are used to capture background at night or under dim light.

1 Press (flash mode).

- The flash menu is displayed.



2 Press the multi selector or to choose the desired flash mode and press .

- The monitor will return to the normal display for the current mode if the setting is not applied by pressing  within five seconds.
- For information on using the multi selector, see “Multi Selector” ( 8).
- The icon for the selected flash mode is displayed at the top of the monitor.
- When  is selected, the icon is only displayed for five seconds after the setting is applied.
- The flash mode applied in  mode is stored in the camera’s memory even after the camera is turned off.

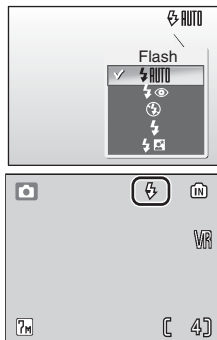

✓ When Lighting is Poor

Note the following when lighting is poor and the flash is off (⊕).

- Place the camera on a flat, level surface or use a tripod (recommended). When using a tripod, turn the vibration reduction off (⊗ 21).
- The **ISO** icon is displayed when the camera increases sensitivity from the normal sensitivity to minimize blur caused by slow shutter speeds. The picture taken when the **ISO** icon is displayed may be slightly mottled.
- The camera may process pictures to reduce noise, which makes recording time increase.

✓ Note on Using the Flash

When using the flash at a wide-angle zoom position, bright reflections from dust particles in the air may appear as bright spots in the pictures. To reduce these reflections, set the flash to ⊕ (Off) in the monitor or zoom in on the subject.

✍ The Flash Lamp

The flash lamp indicates flash status when the shutter-release button is pressed halfway.

- **On** : Flash will fire when picture is taken.
- **Blinks**: Flash charging. Wait a few seconds and try again.
- **Off** : Flash will not fire when picture is taken.

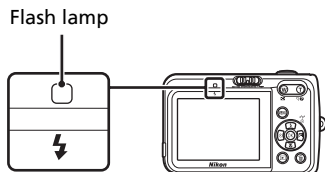

✍ Red-eye Reduction

The COOLPIX L5 is equipped with an advanced red-eye reduction system. Pre-flashes are fired several times at low intensity before the main flash to reduce “red-eye”. If the camera detects “red-eye” after a picture is taken, Nikon’s own In-Camera Red-Eye Fix processes the image as it is recorded. Therefore, there is a slight delay before the shutter-release button operates normally to take another picture. Red-eye reduction may not always produce the desired results. In some rare cases, other portion of pictures may be affected. Should this occur, choose another flash mode and try again.

Taking Pictures with the Self-Timer



The camera is equipped with a ten-second timer for self-portraits. When using the self-timer, mount the camera on a tripod (recommended) or rest it on a flat, and stable surface.

1 Press (self-timer).

- The self-timer menu is displayed.



2 Press the multi selector or to choose [On] and press .

- The 10 icon is displayed.
- The monitor will return to the normal display for the current mode if the setting is not applied by pressing  within five seconds.
- For information on using the multi selector, see “Multi Selector” ( 8).

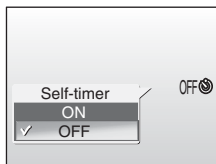

3 Frame the picture and press the shutter-release button halfway.

- The focus and exposure are adjusted.

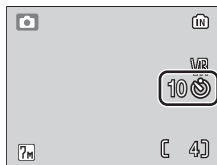

4 Press the shutter-release button fully.

- The self-timer starts.
- The self-timer lamp will blink for about nine seconds. The lamp stops blinking one second before the photograph is taken and remains lit until the shutter is released.
- A countdown of the time remaining until the shutter is released is displayed in the monitor.
- To cancel the self-timer without taking a picture, press the shutter-release button again before the picture is taken.



Macro Close-up Mode



Macro close-up mode is used for taking pictures of objects as close as 4 cm (1.6 in.). Note that the flash may be unable to light shots entire subject at distances of less than 50 cm (1 ft. 7.7 in.). If flash fires, play the picture back and check the results.

1 Press (macro close-up mode).

- The macro close-up mode is displayed.



2 Press the multi selector or to choose [On] and press .

- The  icon is displayed.
- The monitor will return to the normal display for the current mode if the setting is not applied by pressing  within five seconds.
- For information on using the multi selector, see “Multi Selector” ( 8).

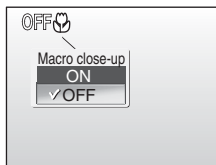

3 Press **T** () or **W** () to frame the picture.

- Minimum focus distance varies with zoom position. The camera can focus at a distance of 4 cm (1.6 in.) at the zoom position at which  turns green.

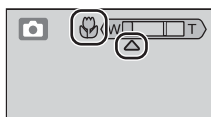

4 Focus and shoot.

- The macro close-up mode applied in  mode is stored in the camera's memory even after the camera is turned off.

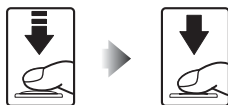

Macro Close-up Mode

In macro close-up mode, the camera focuses continuously, even when the shutter-release button is not pressed halfway to lock focus.



Exposure Compensation

Exposure compensation is used to alter exposure from the value suggested by the camera to make pictures brighter or darker.

1 Press  (exposure).



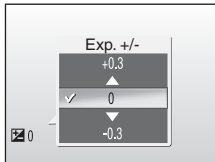

2 Press the multi selector  or  to adjust exposure.

- When the picture is too dark: adjust the exposure compensation to "+" side.
- When the picture is too bright: adjust the exposure compensation to "-" side.
- The monitor will return to the normal display for the current mode if the setting is not applied by pressing  within five seconds.
- Exposure compensation can be set to values between -2.0 and +2.0 EV.
- For information on using the multi selector, see "Multi Selector" ( 8).



3 Press .

- The  icon is displayed in the monitor.
- The exposure compensation applied in  mode is stored in the camera's memory even after the camera is turned off.

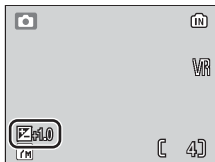

Scene Mode

The camera offers a choice of “assist” and “scene” modes. In these mode, camera settings are automatically optimized for the selected subject type.

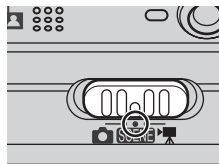

Scene Assist Modes (four types)

Scene assist modes offer framing assist options to help you compose your shots.



Portrait

Use for portraits. The main subject stands out clearly while the background details are softened, lending a sense of depth to the composition.



Landscape

Use for vivid landscape shots that enhance outlines, colors, and contrast in such subjects as skyscapes and forests.



Sports

Fast shutter speeds freeze fast-moving subjects for dynamic sports scenes.



Night portrait

Use for a natural balance between the main subject and background lighting in portraits shot taken at night.

Scene Modes (eleven types)

Scene modes allow you to take pictures optimized for a particular subject type by simply choosing a scene mode and pressing the shutter-release button.













 Party/indoor	 Night landscape	 Copy
 Beach/snow	 Close up	 Back light
 Sunset	 Museum	 Panorama assist
 Dusk/dawn	 Fireworks show	



Image Mode

The [ Image mode] ( 73) can be set in the assist menu of the scene assist modes or in the scene menu. Changes made to the image mode setting apply to all shooting modes.

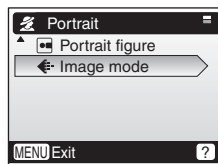

Scene Assist Modes

These modes offer a selection of framing assist options that allow you to compose pictures with the help of framing guides displayed in the monitor.

Taking Pictures in Scene Assist Modes

1 Select **SCENE** mode.

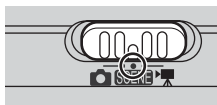

2 Press **MENU** to display the scene menu.

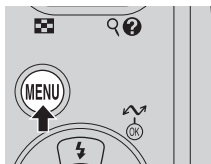

3 Press the multi selector **▲** or **▼** to choose a scene assist mode and press **OK**.

- The framing assist menu is displayed.
- For information on using the multi selector, see "Multi Selector" (p. 8).

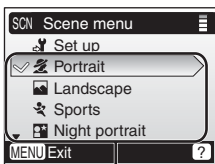

Scene assist modes

4 Press **▲** or **▼** to choose the appropriate composition type and press **OK**.

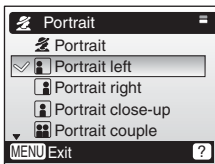

5 Frame a picture and shoot.

- When the framing guides are displayed, position the subject in the framing guides.

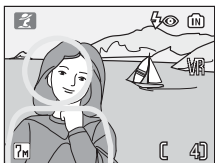

Portrait Assist

Use this mode for portraits in which the main subject stands out clearly while background details are softened. Portrait subjects exhibit smooth, natural-looking skin tones.



Portrait

Camera focuses on subject in the center of the monitor. No guides are displayed.

Portrait left

Compose shot with subject in the left half of the frame. Camera focuses on subject inside the framing guides.

Portrait right

Compose shot with subject in the right half of the frame. Camera focuses on subject inside the framing guides.

Portrait close-up





Compose shot with subject's face in the top half of the frame. Camera focuses on face area inside the framing guides.

Portrait couple

Compose shot with two subjects side-by-side. Camera focuses on subjects inside the framing guides.

Portrait figure

Compose shot in "tall" orientation. Camera focuses on subject inside the framing guides. Pictures taken in "tall" (portrait) orientation are displayed in the same "tall" (portrait) orientation in the monitor.

 Flash:	Changeable (Default:  (Red-eye reduction flash))
 Self-timer:	Available
 Macro close-up:	Off
 Exposure compensation:	Available

Scene Assist Modes

Landscape Assist

Use this mode for vivid landscapes, cityscapes, and portraits featuring a landmark in the background.



Landscape

Camera focuses at infinity. No guides are displayed.*

Scenic view

Use to photograph distant skylines. Camera focuses at infinity.* Align top of skyline with the wavy framing guide displayed to determine the composition.

Architecture

Use to photograph buildings. Camera focuses at infinity.* A grid is displayed in the monitor to help keep verticals and horizontals aligned with the frame.

Group right

Use to compose portraits with portrait subjects to right and landmark or other objects in background at left of frame.

Group left

Use to compose portraits with portrait subjects to left and landmark or other objects in background at right of frame.

 Flash:	[Landscape], [Scenic view], [Architecture]:  (Off) [Group right], [Group left]: Changeable (Default:  (Auto))
 Self-timer:	Available
 Macro close-up:	Off
 Exposure compensation:	Available

* Focus indicator ( 22) is always displayed in green when the shutter-release button is pressed halfway; note, however, that objects in foreground may not always be in focus.

Sports Assist

Use this mode for dynamic action shots that freeze the action in a single shot or record motion in a series of pictures. No framing guides are displayed.



Sports

While the shutter-release button is held down, pictures are taken at rate of about 0.7 frames per second (fps).

Sport spectator

As above, except that camera focuses at ranges of 2 m (6 ft.) to infinity at maximum wide-angle zoom position and 30 m (98 ft.) to infinity at maximum telephoto position.

Sport composite

Each time the shutter-release button is pressed, camera takes 16 shots in about 2 seconds and arranges them in four rows to form a single picture (📷 Normal: 3,072 × 2,304 pixels). Camera focuses continuously even when the shutter-release button is not pressed.

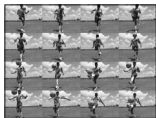





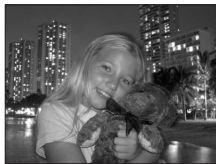

 Flash:	 (Off)
 Self-timer:	Off
 Macro close-up:	Off
 Exposure compensation:	Available

Night Portrait Assist

Use this mode to achieve a natural balance between the main subject and background lighting in portraits shot taken at night. This mode offers the same assist options as portrait assist mode ( 33). Pictures taken at slow shutter speeds are processed to reduce noise; to prevent blurring, mount the camera on a tripod or rest it on a flat, stable surface.



 Flash:	 (Fill flash with slow sync and red-eye reduction)  is displayed in the monitor.)
 Self-timer:	Available
 Macro close-up:	Off
 Exposure compensation:	Available (Default: ± 0)

Using a Tripod

Turn vibration reduction ( 21) off when using a tripod.

Noise Reduction

Noise reduction ( 27) may be automatically applied as pictures taken in night portrait assist mode are recorded.

Scene Modes

Taking Pictures in Scene Modes

1 Select **SCENE** mode.

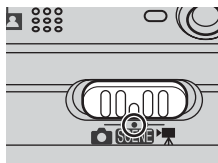

2 Press **MENU** to display the scene menu.

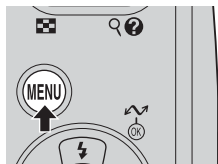

3 Press the multi selector **▲** or **▼** to choose the scene mode and press **OK**.

- Three pages of scene modes are available, beginning with [Party/indoor] and ending with [Panorama assist].
- For information on using the multi selector, see "Multi Selector" (p. 8).

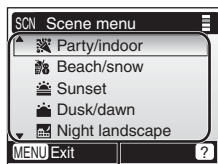

Scene modes

4 Frame the subject and take the picture.

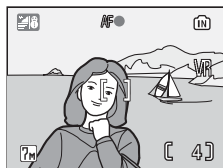

Scene Modes





The following scene modes are available:

Party/indoor

Captures the effects of candlelight and other indoor background lighting.

- Camera focuses on subject in the center of the frame.
- Turn vibration reduction ( 21) on and hold the camera steadily to prevent camera shake.







 Flash:	Changeable (Default:  (Auto with red-eye reduction))
 Self-timer:	Available
 Macro close-up:	Off
 Exposure compensation:	Available

Beach/snow

Captures the brightness of such subjects as snowfields, beaches, or sunlit expanses of water.



- Camera focuses on subject in the center of the frame.







 Flash:	Changeable (Default:  AUTO (Auto))
 Self-timer:	Available
 Macro close-up:	Available
 Exposure compensation:	Available

Sunset

Preserves the deep hues seen in sunsets and sunrises.

- Camera focuses at infinity. Focus indicator ( 22) always lights up green when the shutter-release button is pressed halfway; note, however, that objects in foreground may not always be in focus.
- Turn vibration reduction ( 21) on and hold the camera steadily to prevent camera shake.



 Flash:	 (Off)
 Self-timer:	Available
 Macro close-up:	Off
 Exposure compensation:	Available

 Dusk/dawn

Preserves the colors seen in the weak natural light before sunrise or after sunset.

- Camera focuses at infinity. Focus indicator ( 22) always lights up green when the shutter-release button is pressed halfway; note, however, that objects in foreground may not always be in focus.
- Use of a tripod recommended to prevent blurring.





 Flash:	 (Off)
 Self-timer:	Available
 Macro close-up:	Off
 Exposure compensation:	Available

 Night landscape

Slow shutter speeds are used to produce stunning night landscapes.

- Camera focuses at infinity. Focus indicator ( 22) always lights up green when the shutter-release button is pressed halfway; note, however, objects in foreground may not always be in focus.
- Use of a tripod recommended to prevent blurring.



 Flash:	 (Off)
 Self-timer:	Available
 Macro close-up:	Off
 Exposure compensation:	Available

 Using a Tripod

Turn vibration reduction ( 21) off when using a tripod.

 Noise Reduction

Noise reduction ( 27) may be automatically applied as pictures taken in dusk/dawn and night landscape modes are recorded.





Scene Modes

Close up

Photograph flowers, insects, and other small objects at close range ( 29).



- Camera focuses continuously until the shutter-release button is pressed halfway to lock focus.
- Turn vibration reduction ( 21) on and hold the camera steadily to prevent camera shake.







 Flash:	Changeable (Default:  (Off))
 Self-timer:	Available
 Macro close-up:	Off
 Exposure compensation:	Available

Museum

Use indoors where flash photography is prohibited (for example, in museums and art galleries) or in other settings in which you do not want to use the flash.

- Camera focuses on subject in the center of the frame.
- [BSS] ( 79) turns on automatically.
- Turn vibration reduction ( 21) on and hold the camera steadily to prevent camera shake.







 Flash:	 (Off)
 Self-timer:	Available
 Macro close-up:	Available
 Exposure compensation:	Available

Fireworks show

Slow shutter speeds are used to capture the expanding burst of light from a firework.

- Camera focuses at infinity. Focus indicator ( 22) always lights up green when the shutter-release button is pressed halfway; note, however, that objects in foreground may not always be in focus.
- Use of a tripod recommended to prevent blurring.



 Flash:	 (Off)
 Self-timer:	Off
 Macro close-up:	Off
 Exposure compensation:	Not available

Copy

Provides clear pictures of text or drawings on a white board or in print.

- Camera focuses on subject in the center of the frame.
- Use macro close-up mode (📷 29) to focus at short ranges.
- Colored text and drawings may not show up well.



⚡ Flash:	Changeable (Default: ⓧ (Off))
🕒 Self-timer:	Available
🌿 Macro close-up:	Available
☑️ Exposure compensation:	Available

Back light

Use when light is coming from behind your portrait subject, throwing features or details into shadow. The flash fires automatically to “fill-in” (illuminate) shadows.

- Camera focuses on subject in the center of the frame.



⚡ Flash:	⚡ (Fill flash)
🕒 Self-timer:	Available
🌿 Macro close-up:	Off
☑️ Exposure compensation:	Available

Horizon Panorama assist (📷 42)

Use when taking a series of pictures that will later be joined to form a single panorama using PictureProject.

⚡ Flash:	Changeable (Default: ⓧ (Off))
🕒 Self-timer:	Available
🌿 Macro close-up:	Available
☑️ Exposure compensation:	Available

Taking Pictures for a Panorama (41)

The camera focuses on the subject in the center of the frame. Use a tripod for best results.

- 1 Press the multi selector ▲ or ▼ to choose [Panorama assist] in the scene menu and press OK.

- The ▷ icon appears in yellow to indicate the panorama direction (that is, the direction in which pictures are serialized).
- For information on using the multi selector, see “Multi Selector” (8).

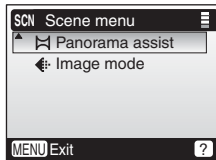

- 2 Take the first picture.

- The first picture is displayed in the first third of the monitor.



- 3 Take the second picture.

- Compose the next picture so that it overlaps the first picture.
- Repeat until you have taken the necessary number of pictures to complete the series.



- 4 Press OK to finalize the series.

- Monitor display returns to that shown in step 2.



✔ Panorama Assist

Flash mode (☰ 26), self-timer (☰ 28), macro close-up (☰ 29) and exposure compensation (☰ 30) settings cannot be adjusted after the first picture is taken. Pictures cannot be deleted, nor can zoom or image mode setting (☰ 73) be adjusted until the series is finalized.



🔒 AE-L

The AE-L icon (white) is displayed to show that white balance and exposure have been locked at the values set with the first shot. All pictures taken in a panorama series have the same exposure and white balance settings.



Taking Pictures in the One-Touch Portrait Mode

For portrait shots, press  when the camera is in the auto mode, scene mode and movie mode. The following features are automatically activated:

- Portrait: Portrait subjects stand out clearly while background details are softened, lending a sense of depth to the composition.
- Face-priority AF: Face-priority AF is enabled to allow the camera to automatically recognize human faces.
- Auto red-eye reduction: The flash mode is automatically set to  (auto with red-eye reduction:  26).

Press  again to return to the shooting mode indicated with the mode selector.

1 Press .

- The  guide is displayed.

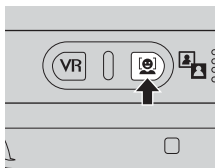

2 Frame a picture using the guide.

- When the camera detects a face, the guide is displayed with a double yellow border.
- When the camera detects more than one face, the closest face is framed by a double border and the rest by a single border. The camera focuses on the face framed by the double border. If the camera loses its ability to detect a face (for example, because the subject has looked away from the camera), borders are no longer displayed and monitor display returns to that shown in step 1.

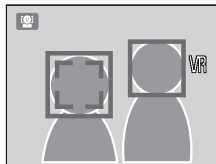

3 Press the shutter-release button halfway.

- Focus and exposure are set, and the double border turns green.

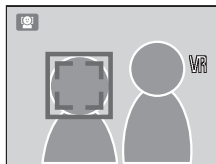

4 Press the shutter-release button the rest of the way down to take a picture.



Face-Priority AF

- The camera's ability to detect faces depends on a variety of factors, including whether or not the subject is facing the camera.
- The camera will focus continuously until a face detected.
- If the yellow double border blinks when the shutter-release button is pressed halfway, the camera was unable to focus. Release the button and try again.
- If no face is recognized when the shutter-release button is pressed halfway, the camera focus is on the center of the frame.
- The camera may be unable to detect faces in the following situations;
 - When faces are partially hidden by sunglasses or other obstructions
 - When faces take up too much or too little of the frame
- When face-priority AF recognizes one or more faces with shooting in "tall" orientation, pictures are displayed in "tall" orientation when played back in the camera monitor.

Settings for One-Touch Portrait Mode

- Flash: Changeable
- Self-timer/Exposure compensation: Available
- Macro close-up: Off
- One-touch portrait: Changeable ( 46)

The One-Touch Portrait Menu

The one-touch portrait menu contains the image mode option, and the portrait option that allows you to apply tone effect to images.



Set up

Display the setup menu (☒ 88).



Image mode

Choose an image mode (☒ 73).



Portrait effect

Choose from [Normal], [Brighter] (brightens skin tones), and [Softer] (softens the overall image).

Applying Portrait Effect

- 1 Press **MENU** in the one-touch portrait mode.

- The one-touch portrait menu is displayed.

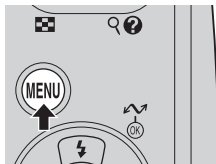

- 2 Press the multi selector ▲ or ▼ to choose [Portrait effect] and press **OK**.

- The options available for [Portrait effect] are displayed.
- For information on using the multi selector, see "Multi Selector" (☒ 8).

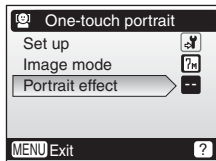



- 3 Press ▲ or ▼ to choose the option and press **OK**.

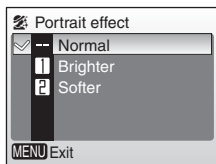







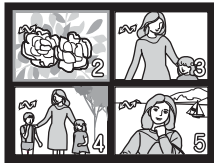





- The setting is applied and the one-touch portrait menu is displayed.
- Press **MENU** to return the one-touch portrait menu without applying the setting.



Viewing Multiple Pictures: Thumbnail Playback

Pressing  (**W**) in full-frame playback ( 24) to display pictures in “contact sheets” of four, nine, or sixteen thumbnail images. The following operations can be performed while thumbnails are displayed:



To	Press	Description	
Choose pictures		Press the multi selector  ,  ,  , or  to choose pictures.	8
Change number of pictures displayed		With four thumbnails displayed, press  (W) once to view nine thumbnails, or twice to view sixteen thumbnails. With sixteen thumbnails displayed, press  (T) once to display nine thumbnails or twice to display four thumbnails. With four thumbnails displayed, press  (T) to return to full-frame playback.	–
Cancel thumbnail playback		Cancel thumbnail playback and return to full-frame playback.	–
Delete picture		Confirmation dialog will be displayed. Choose [Yes] and press  to delete.	24
View playback menu	MENU	Display the playback menu.	82
Switch to shooting mode		Switch to the shooting mode selected with the mode selector.	24

Taking a Closer Look: Playback Zoom





Press **Q (T)** to zoom in on still images displayed in full-frame playback (24). Playback zoom is not available when the current picture is a movie or a copy created using the small picture option.

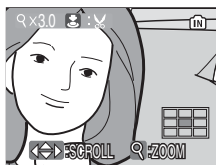

Press **OK** to enlarge the view of the picture currently displayed in full-frame playback (24) 3x. The center of the picture is visible in the monitor (quick playback zoom).





The playback zoom ratio is displayed in the monitor while the pictures are zoomed in with quick playback zoom, and the following operations can be performed :

To	Press	Description	24
Zoom in	Q (T)	Zoom increases each time Q (T) is pressed, to a maximum of 10x. While the image is zoomed in, the zoom ratio is displayed in the top left corner of the monitor.	–
Zoom out	W (W)	Zoom decreases each time W (W) is pressed. To cancel playback zoom, zoom out until entire picture is displayed.	–
View other areas of picture		Use the multi selector to scroll to areas of picture not visible in the monitor. To use the multi selector to view other pictures, cancel playback zoom. In quick playback zoom, scroll to areas of picture not visible by pressing ▲ , ▼ , ◀ , or ▶ referring to the guide displayed in the lower right corner of the monitor.	8
Crop picture		Crop current picture to contain only the portion visible in the monitor.	49
Return to full-frame playback	OK	Cancel playback zoom and return to full-frame playback.	–
Delete picture		Confirmation dialog will be displayed. Choose [Yes] and press OK to delete.	24
View playback menu	MENU	Display the playback menu.	82
Switch to shooting mode		Switch to the shooting mode selected with the mode selector.	24

Editing Pictures



Creating a Cropped Copy: Crop

If the  icon is displayed in the monitor with playback zoom enabled ( 48), the portion of the picture currently visible in the monitor can be saved as a separate file.

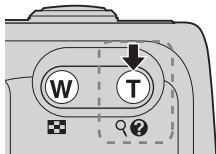
- 1 Press **Q** (**T**) to zoom in on the image in full-frame playback.



- 2 Adjust display so that only the portion of the picture to be saved is shown.

- Press **Q** (**T**) or  (**W**) to adjust the zoom ratio.
- Press the multi selector **▲**, **▼**, **◀**, or **▶** to scroll to areas of the picture not currently visible in the monitor.
- For information on using the multi selector, see “Multi Selector” ( 8).

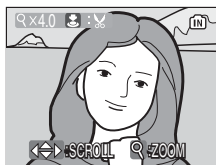

- 3 Press the shutter-release button.

- The confirmation dialog will be displayed.











- 4 Press **▲** or **▼** to choose [Yes] and press **OK**.

- A new picture, containing only the area visible in the monitor, is created.



Cropped Copy Image Mode

Depending on the size of the original picture and the zoom ratio in effect at the time the copy was created, the camera will automatically select one of the following image-mode settings for cropped copies. (Unit: pixel)

- | | | |
|---|---|---|
| •  2,592 × 1,944 | •  2,272 × 1,704 | •  2,048 × 1,536 |
| •  1,600 × 1,200 | •  1,280 × 960 | •  1,024 × 768 |
| •  640 × 480 | •  320 × 240 | •  160 × 120 |

Enhancing Contrast: D-Lighting



D-Lighting can be used to create copies, with enhanced brightness and contrast, of pictures affected by backlighting or insufficient flash lighting.

1 Display the desired picture in full-frame playback (⏮ 24) and press (Ⓛ).

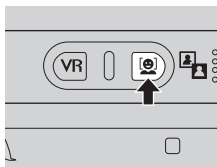
- D-Lighting copies can also be created by pressing  (Ⓛ) after selecting a picture in thumbnail playback mode.
- The original picture is displayed at left and the picture applied with D-lighting enhancement is displayed at right.



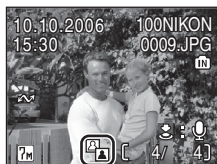
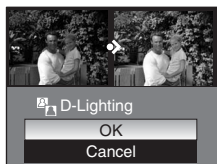

2 Press the multi selector ▲ or ▼ to choose [OK] and press .

- A new copy with enhanced brightness and contrast is created.
- To exit without creating a new copy, choose [Cancel] and press .
- For information on using the multi selector, see "Multi Selector" (Ⓜ 8).
- D-Lighting copies can be recognized by the  icon displayed during playback.



Resizing Pictures: Small Picture

Create a small copy of the current picture. Copies are stored as JPEG files with compression ratio of 1 : 16. Choose from the following sizes:

 640×480	Suited to television playback.
 320×240	Suited to display on web pages.
 160×120	Suitable for e-mail attachments.

- 1** Display the desired picture in playback mode ( 24) and press **MENU**.

- The playback menu is displayed.

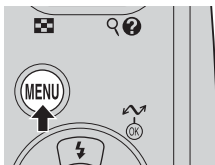

- 2** Press the multi selector **▲** or **▼** to choose [Small pic.] and press **OK**.

- The small picture options are displayed.
- For information on using the multi selector, see "Multi Selector" ( 8).

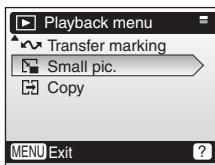

- 3** Press **▲** or **▼** to choose the desired copy size and press **OK**.

- The confirmation dialog will be displayed.
- To exit without creating a new copy, press **MENU**.

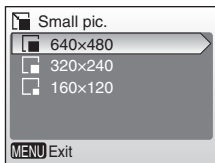

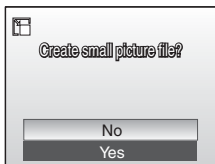

- 4** Press **▲** or **▼** to choose [Yes] and press **OK**.

- A small picture copy is created at the chosen size.



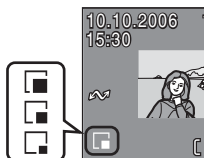

Editing Pictures

Small copies are recognized by their gray border and the , , or  icon displayed during playback.



Restrictions on Picture Editing



The following restrictions apply to copies created using crop (, 49), D-Lighting (, 50), and small picture (, 51).

- Copies created using the crop or small picture functions cannot be edited again.
- The D-Lighting function cannot be used on copies created using the D-Lighting function. In other words, this function can only be applied to a picture once.



Picture Editing

- The COOLPIX L5 editing functions may not be available for pictures taken with non-COOLPIX L5 digital cameras.
- If a copy created using the COOLPIX L5 is viewed on a different digital camera, the picture may not be displayed or may not be transferred to a computer.
- Editing functions are not available when there is not enough free space in the internal memory or on the memory card.

Original Pictures and Edited Pictures



- Copies created with editing functions are not deleted if the original pictures are deleted. The original pictures are not deleted if copies created with editing functions are deleted.
- Edited copies are stored with the same recording date and time as the original.
- Copies created using crop, D-Lighting, and small picture have the same transfer marking (, 86) as the original but are not marked for printing (, 70) or protecting (, 85).

Voice Memos: Recording and Playback

The camera's built-in microphone can be used to record voice memos for pictures indicated by the  (voice memo recording guide) icon in full-frame playback ( 24).

Recording Voice Memos



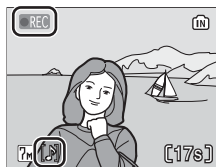

Press and hold the shutter-release button to record a voice memo. Recording ends after about 20 seconds or when the shutter-release button is released.

- Do not touch the built-in microphone during recording.
- During recording,  and  blink in the monitor display.





Playing Voice Memos

Select a picture with a recorded voice memo and press the shutter-release button to play it back. Playback ends when the voice memo ends or the shutter-release button is pressed again.

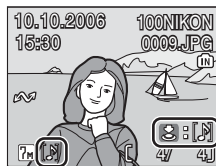
- Pictures with voice memos are indicated by the  and  icons in full-frame playback.
- Press **W** () or **T** () to adjust the volume.



Deleting Voice Memos

Select a picture with a recorded voice memo and press . Choose  and press  to delete the voice memo only.



Voice Memos

- Voice memo file names are the same as those of the images they attach to except that the extension is ".WAV", e.g., "DSCN0015.WAV" ( 104).
- If a voice memo already exists for the current picture, it must be deleted before a new voice memo can be recorded.

Movie Mode

Follow the instructions below to shoot movies with sound recorded via the built-in microphone.

1 Select mode.

- The maximum length of the movie that can be recorded is displayed in the monitor.

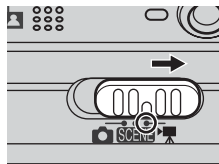



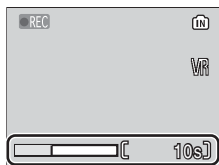

2 Press the shutter-release button to start recording.

- A progress bar at the bottom of the monitor shows the amount of recording time remaining.
- To end recording, press the shutter-release button again.
- Recording will end automatically when the internal memory or memory card is full.



Recording Movies

- The flash (, 26), self-timer (, 28), and exposure compensation (, 30) can not be used in movie mode. Macro close-up (, 29) can be used while movies are being recorded.
- Digital zoom (up to 2x) can be applied ([TV movie 640] up to 1.9x) while movies are being recorded. Adjust zoom before beginning recording. Once recording begins, optical zoom cannot be adjusted.
- Vibration reduction (, 21) is only available at a setting of **VR** (Normal).



Settings for Movie Mode

The movie options and the auto-focus mode option can be set in the movie menu (, 55, 56).

The Movie Menu

Movie Options

The movie menu offers the options shown below.



Option	Description	Maximum movie length ¹	
		Internal memory	Memory card
		8 MB	256 MB
 TV movie 640	Movies are recorded at 30 frames per second. Each frame is 640 × 480 pixels in size.	5 sec.	2 min. 50 sec. ²
 Small size 320 (default setting)	Movies are recorded at 30 frames per second. Each frame is 320 × 240 pixels in size.	13 sec.	6 min. 30 sec.
 Smaller size 160	Movies are recorded at 30 frames per second. Each frame is 160 × 120 pixels in size. Small size allows for recording of longer movies.	50 sec.	25 min.

¹ All figures are approximate. Maximum movie length may vary depending on type of memory card used.

² To prevent **TV movie 640** from ending unexpectedly, use card rated for 10 MB/s.

Auto-Focus Mode

Choose how the camera focuses in movie mode.

Option	Description
 Single AF (default setting)	Camera focuses when the shutter-release button is pressed half-way and locks at this position during recording.
 Full-time AF	Camera constantly adjusts focus, even when the shutter-release button is not pressed. Choose [Single AF] if the sound of the camera focusing interferes with recording.

Movie File and Folder Names

See “Image File and Folder Names” (104).

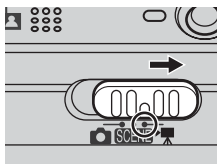

Applying Movie Setting

- 1 Select  mode.



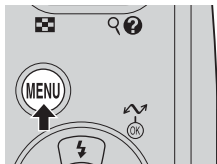

- 2 Press **MENU**.
- The movie menu is displayed.

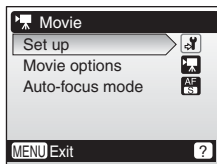

- 3 Press the multi selector  or  to choose [Movie options] or [Auto focus mode] and press **OK**.

- The options available for the selected item are displayed.
- For information on using the multi selector, see "Multi Selector" (8).



- 4 Press  or  to choose the desired setting and press **OK**.

- The setting is enabled and the movie menu is displayed.
- Press **MENU** to return to the main movie menu without applying the setting.

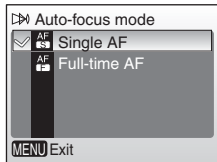
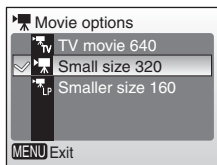

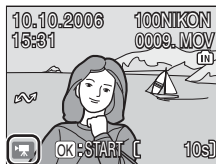

Movie Playback

In full-frame playback (F24), movies are recognized by the  icon. To play a movie, display it in full-frame playback and press **OK**.



Playback display





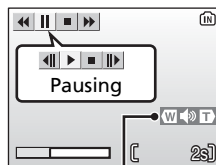

Use **W** (F24)/**T** (Q) to adjust playback volume.

Playback controls are displayed at the top of the monitor. Press the multi selector  or  to choose a control, then press **OK** to perform the selected operation.

For information on using the multi selector, see “Multi Selector” (F8).



Volume indicator

To	Press	Description
Rewind		Movie rewinds while OK is pressed.
Fast forward		Movie advances while OK is pressed.
Pause		Pause playback. The following operations can be performed while playback is paused.
		 Rewind movie by one frame.
		 Advance movie by one frame.
		 Resume playback.
Stop		Stop playback and return to full-frame playback.

Deleting Movie Files

Display a movie in full-frame (F24) or thumbnail playback mode (F47) and press .

A confirmation dialog is displayed. Choose [Yes] and press **OK** to delete the movie, or choose [No] and press **OK** to return to the normal playback display without deleting the movie.



You can connect your camera to your television, computer, or printer to view pictures you have taken.

Connecting to a TV (📺 59)

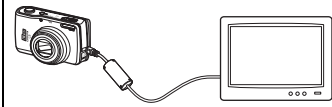

View pictures on a TV by connecting your camera via the supplied audio/video cable.

Connecting to a Computer (💻 60)

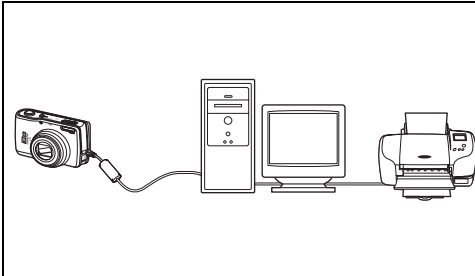

Use the supplied PictureProject software to copy pictures to a computer, and then organize, browse, edit, and save those pictures. Connect the camera to the computer using the supplied USB cable. You can also print pictures from a printer connected to the computer using PictureProject installed in the computer.

Connecting to a Printer (🖨️ 64)

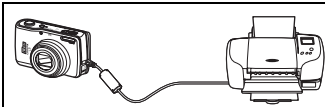

Connect your camera directly to a PictBridge-compatible printer. Use the supplied USB cable to connect the camera to a printer for direct printing.

✔ Before Connecting the Camera

Use fresh batteries or the EH-65A AC adapter kit (available separately) to prevent the camera from turning off unexpectedly while connected.

🔍 Playback, Transfer, or Print Pictures from Internal Memory

To view pictures stored in the camera's internal memory on a TV, or to transfer them to a computer or print with direct connection to a printer, remove the memory card from the camera.

🖨️ Printing Pictures

In addition to printing pictures transferred to a computer from your personal printer and printing over a direct camera-to-printer connection, the following options are also available for printing pictures:

- Insert a memory card into a DPOF-compatible printer's card slot
- Take a memory card to a digital photo lab

For printing using these methods, specify the pictures and the number of prints each using your camera's [Print set] menu (📄 70).

Connecting to a TV

Connect the camera to a television using the audio/video (A/V) cable to play back pictures on the television.

1 Turn the camera off.

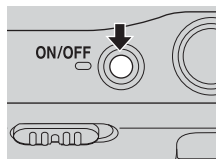

2 Connect the A/V cable.

- Connect the yellow plug to the video-in jack on the TV, and the white plug to the audio-in jack.

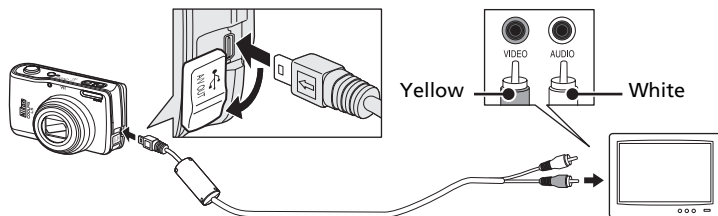

3 Tune the television to the video channel.

- See the documentation provided with your television for details.

4 Press for one second to turn the camera on.

- The camera monitor will remain off and the image normally shown in the monitor will be displayed on the television.



Connecting the A/V Cable

- When connecting the A/V cable, be sure that the camera connector is oriented correctly. Do not use force when connecting the A/V cable to the camera. When disconnecting the A/V cable, do not pull the connector at an angle.
- Do not pinch the connector cover between the camera's A/V connector and the A/V cable connector when connecting the cable to the camera.

Video Mode

Be sure that the camera's video mode setting conforms to the standard used by your television. The video mode setting is an option in the [Interface] (88) item in the setup menu (88).

Connecting to a Computer

Use the USB cable and PictureProject software supplied with your camera to copy (transfer) pictures to a computer.

Before Connecting the Camera

Installing PictureProject

Before transferring pictures or movies to a computer, PictureProject must be installed. For more information on installing and using PictureProject, see the *Quick Start Guide*.

Confirming USB Option



The following two methods can be used to transfer pictures from the camera to a computer:

- Press  (OK) on the camera.
- Click [Transfer] in PictureProject.

The method used will depend on your computer's operating system and the USB option selected in the camera's setup menu.

Operating system	USB option ¹	
	 (OK) on the camera ²	PictureProject Transfer button
Windows XP Home Edition Windows XP Professional	Choose [Mass storage] or [PTP].	
Windows 2000 Professional ³	Choose [Mass storage].	
Mac OS X (10.3.9 or later)	Choose [PTP].	Choose [Mass storage] or [PTP].

¹ This camera supports the USB mass storage device class (default setting [Mass storage]) and Picture Transfer Protocol ([PTP]) USB transfer protocols.

² The camera's  (OK) button cannot be used to transfer pictures when the memory card write-protect switch is in the "lock" position. Use the [Transfer] button in PictureProject. To use  (OK) on the camera, unlock by sliding the switch to the "write" position before transferring pictures.

³ If your computer is running Windows 2000 Professional, be sure to set the USB option to [Mass storage]. If [PTP] is selected, the Found New Hardware Wizard will be displayed when the camera is connected to the computer. Select [Cancel], close the window, and disconnect the camera from the computer.

Setting the USB Option

Set the USB option (99) in the setup menu on the camera before connecting the camera to the computer or printer.

- 1 Press **MENU**.

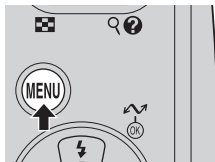

- 2 Press the multi selector **▲** or **▼** to choose [Set up] and press **OK**.

- The setup menu is displayed.
- For information on using the multi selector, see "Multi Selector" (8).

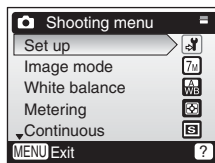

- 3 Press **▲** or **▼** to choose [Interface] and press **OK**.

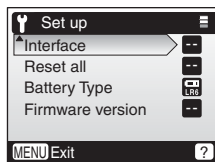

- 4 Press **▲** or **▼** to choose [USB] and press **OK**.

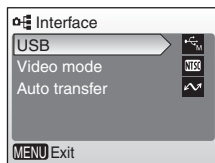

- 5 Press **▲** or **▼** to choose [PTP] or [Mass storage] and press **OK**.

- The setting is enabled.
- To finish setting, press **MENU**.

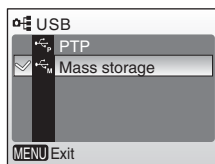

Transferring Pictures to a Computer

- 1 Turn on a computer to which PictureProject has been installed.
- 2 Turn the camera off and connect the USB cable as shown below.

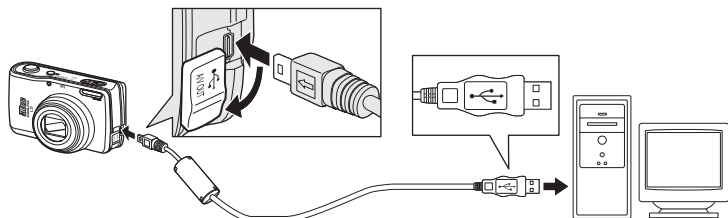

- 3 Turn the camera on.
 - At default PictureProject settings, PictureProject Transfer is launched immediately with recognition of camera connection.

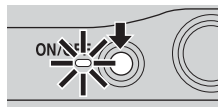



- 4 Transfer pictures and movies.

- **Transfer using PictureProject**

While PictureProject Transfer is launched, click [Transfer] of PictureProject Transfer.

All pictures and movies marked for transfer are copied to the computer. Once transfer is complete, pictures are displayed in PictureProject.

- **Transfer using  (OK) on the camera**

While PictureProject Transfer is launched, press  (OK) on the camera to copy pictures marked for transfer ( 63) to the computer. The following messages are displayed in the camera monitor during transfer.



Connecting the USB Cable

- When connecting the USB cable, be sure that the connectors are oriented correctly. Do not use force when connecting the USB cable. When disconnecting the USB cable, do not pull the connector at an angle.
- Do not pinch the connector cover between the camera's USB connector and the USB cable connector when connecting the cable to the camera.

5 Disconnect the camera once transfer is complete.

- **If the USB option is set to [PTP]**

Turn the camera off and disconnect the USB cable.

- **If the USB option is set to [Mass storage]**

Remove the camera from the system as described below before turning the camera off and disconnecting the USB cable.

Windows XP Home Edition/Windows XP Professional

Click the [Safely Remove Hardware] icon () in the taskbar and select [Safely remove USB Mass Storage Device] from the menu displayed.

Windows 2000 Professional

Click the [Unplug or Eject Hardware] icon () in the taskbar and select [Stop USB Mass Storage Device] from the menu displayed.



Macintosh

Drag the untitled camera volume ("NO NAME") to the Trash.



Marking Pictures for Transfer

Pictures marked for transfer are recognized by the  icon displayed during playback. By default, all pictures are automatically marked for transfer. Two options control transfer marking:

- [Interface]>[Auto transfer] in the setup menu: Choose [On] to mark **all new pictures** for transfer ( 99).
- [Transfer marking] in the playback menu: Change marking for **existing pictures** ( 86).

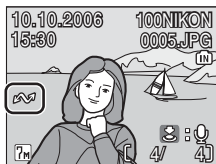

Connecting to a Printer

Users of PictBridge-compatible (📷 117) printers can connect the camera directly to the printer and print pictures without using a computer.

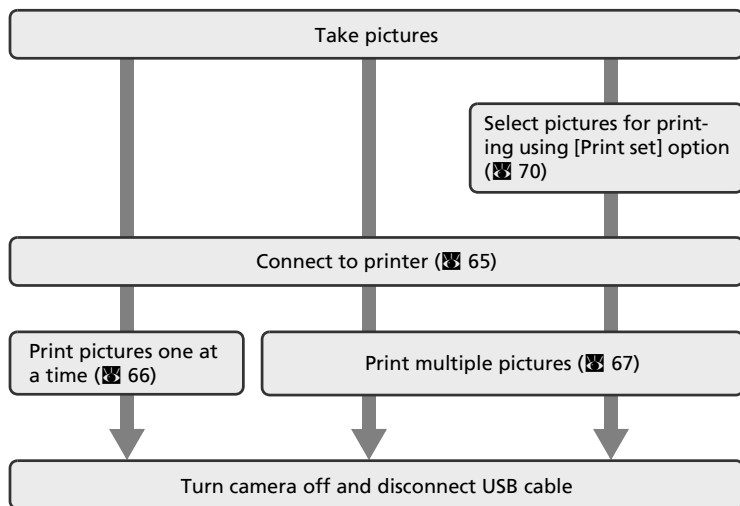

Connecting the Camera and Printer

- 1** Set the USB option ( 61) to [PTP].

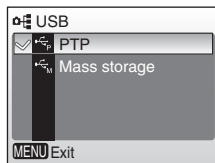

- 2** Turn the camera off.

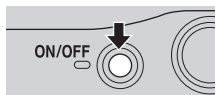

- 3** Turn the printer on.

- Check printer settings.

- 4** Connect the USB cable as shown below.

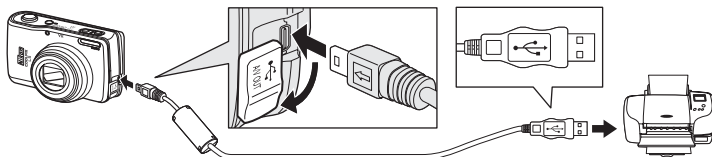

- 5** Turn the camera on.

- The PictBridge start-up screen (①) will be displayed in the camera monitor. The camera will then enter full-frame playback with the PictBridge logo displayed in the top left corner of the monitor (②).

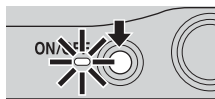

Connecting the USB Cable

- When connecting the USB cable, be sure that the connectors are oriented correctly. Do not use force when connecting the USB cable. When disconnecting the USB cable, do not pull the connector at an angle.
- Do not pinch the connector cover between the camera's USB connector and the USB cable connector when connecting the cable to the camera.

Printing Pictures One at a Time

After connecting the camera to the printer correctly (❌ 65), print pictures by following the procedure below.

1 Press the multi selector ▲, ▼, ◀, or ▶ to choose a picture and press Ⓞ.

- The [PictBridge] menu is displayed.
- To choose a picture from a list of thumbnails, press Ⓞ (W) and use the multi selector to choose the desired picture, or press Q (T) to exit to full-frame playback.
- For information on using the multi selector, see "Multi Selector" (❌ 8).



2 Press ▲ or ▼ to choose [Copies] and press Ⓞ.

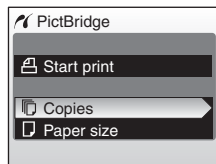

3 Press ▲ or ▼ to choose the number of copies (up to 9) and press Ⓞ.

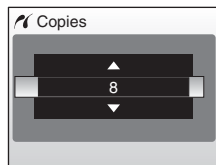

4 Press ▲ or ▼ to choose [Paper size] and press Ⓞ.

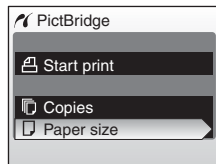

5 Press ▲ or ▼ to choose the desired paper size and press **OK**.

- To specify paper size using printer settings, choose [Default] in the paper size menu and press **OK**.

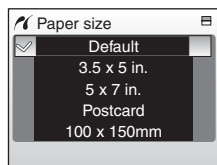

6 Press ▲ or ▼ to choose [Start print] and press **OK**.

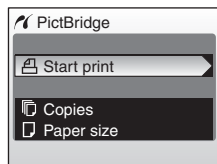

7 Printing starts.

- Monitor display returns to that shown in step 1 when printing is complete.
- Press **OK** to terminate printing before printing is complete.

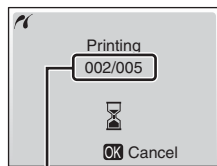

Current print/
total number of prints

Printing Multiple Pictures

After connecting the camera to the printer correctly (❗ 65), print pictures by following the procedure below.

1 Press **MENU**.

- The print menu is displayed.

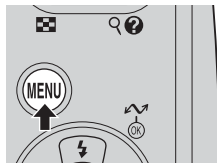

2 Press the multi selector ▲ or ▼ to choose [Paper size] and press **OK**.

- For information on using the multi selector, see "Multi Selector" (8).

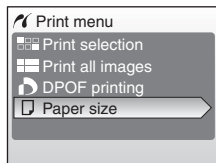

3 Press ▲ or ▼ to choose the desired paper size and press **OK**.

- To specify paper size using printer settings, choose [Default] in the paper size menu and press **OK**.

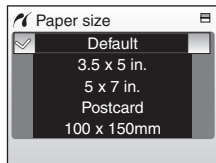

4 Press ▲ or ▼ to choose [Print selection], [Print all images] or [DPOF printing] and press **OK**.

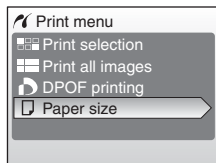

Print selection

Select pictures and specify the number of prints for each picture. Proceed to step 5.

Print all images

All pictures stored in the internal memory or memory card are printed. Proceed to step 7.



DPOF printing

Pictures for which a print order has been created are printed accordingly (70).

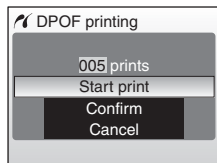
- The options for DPOF printing are displayed.
- To print, press ▲ or ▼ to choose [Start print] and press **OK**. Proceed to step 7.
- To view the current print order, choose [Confirm] and press **OK**. Print order details will be displayed. Proceed to step 6.



5 Choose the pictures and number of copies (up to 9) of each and press **OK**.

- The current picture is shown at the center of the monitor display.
- Press **◀** or **▶** to choose the previous or next picture.
- Press **▲** or **▼** to increase or decrease the number of copies for each picture.
- Pictures selected for printing are recognized by the  icon and the number of copies to be printed. The  icon is not displayed with pictures for which 0 copies have been specified and these pictures will not be printed.
- When the setting is complete, press **OK**.

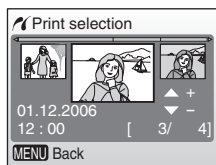

6 Press **▲**, **▼**, **◀**, or **▶** to confirm the pictures and press **OK**.

- Press **MENU** to modify the selection and return to the print selection screen.

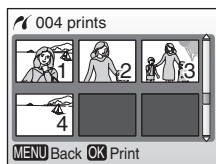

7 Printing starts.

- Monitor display returns to the [Print menu] (step 2) when printing is complete.
- Press **OK** to terminate printing before it is complete.

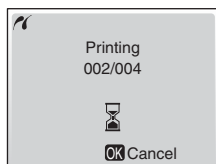

Paper Size

The camera supports the following paper sizes: [Default] (the default paper size for the current printer), [3.5 x 5 in.], [5 x 7 in.], [Postcard], [100 x 150 mm], [4 x 6 in.], [8 x 10 in.], [Letter], [A3], and [A4]. Only sizes supported by the current printer will be displayed.

Creating a DPOF Print Order: Print Set

The [Print set] option in the playback menu is used to create digital “print orders” for printing on DPOF-compatible devices (❏ 117) or at a digital photo lab which supports DPOF.

In addition to pictures themselves, shooting date and photo information (shutter speed and aperture) can also be printed.

When the camera is connected to a PictBridge-compatible printer, pictures can be printed from the printer according to the DPOF print order you have created for pictures on the memory card. If the memory card is removed from the camera, you can create the DPOF print order for pictures in the internal memory and print pictures according to the DPOF print order.

1 Press MENU in playback mode.

- The playback menu is displayed.
- When printing from a PictBridge-compatible printer, create print orders before connecting the camera to the printer.



2 Press the multi selector ▲ or ▼ to choose [Print set] from the playback menu and press OK.

- The [Print set] menu is displayed.
- For information on using the multi selector, see “Multi Selector” (❏ 8).

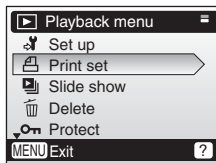

3 Press ▲ or ▼ to choose [Print selected] and press OK.

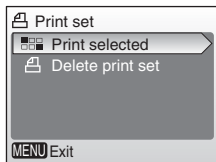

4 Choose the pictures and number of copies (up to 9) of each and press OK.

- The current picture is shown at the center of the monitor display.
- Press ◀ or ▶ to choose the previous or next picture.
- Press ▲ or ▼ to increase or decrease the number of copies for each picture.
- Pictures selected for printing are recognized by the 📄 icon and the number of copies to be printed. The 📄 icon is not displayed with pictures for which 0 copies have been specified and these pictures will not be printed.
- When the setting is completed, press OK.

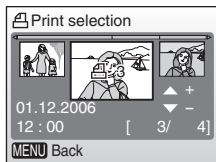

5 Set the date and info options.

Press ▲ or ▼ to choose an option, and press OK to turn ✓ on and enable that option. To turn ✓ off, press OK again.

- [Date]: Print the date of recording on all pictures in print order.
- [Info]: Print shutter speed and aperture on all pictures in the print order. Note that this information is not printed with direct connection to a printer (85 65).
- [Done]: Complete the print order and exit.

Pictures selected for printing are recognized by the  icon displayed with playback.

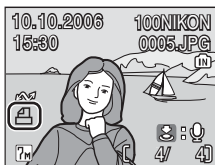
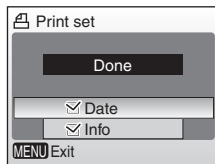

✓ Print Set

[Date] and [Info] are reset each time the print set menu (step 4) is displayed. Information normally printed when [Info] is selected in the print set menu is not printed when the camera is connected directly to the printer.

✎ DPOF Print Order

To delete current print order, choose [Delete print set] in the print set menu (step 3) and press OK.

✎ Notes on the Print Set [Date] Option

The date and time printed on pictures with DPOF printing when [Date] in the print set menu is enabled are those recorded with the picture when it was taken. Date and time printed using this option are not affected when the camera's date and time setting are changed from the setup menu after pictures are recorded.

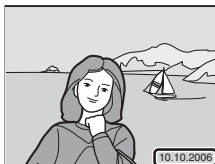

🔄 Differences Between Print Set and Date Imprint

















Date and time can only be printed on pictures using the [Date] option in the print set menu when pictures are printed from a DPOF-compatible printer (85 117).

Use the [Date imprint] (85 95) option in the setup menu to print the date on pictures from a printer that does not support DPOF (position of the date is fixed at the bottom right hand corner of the picture). Once the [Date imprint] option is enabled, the date forms a permanent part of the image and cannot be deleted from pictures.

When the date option for both [Print set] and [Date imprint] is enabled, only the date from the [Date imprint] option is printed, even when a DPOF-compatible printer is used.

Shooting Options: The Shooting Menu

The following options are available in the shooting menu.

	Set up  88
	Display the setup menu.
	Image mode  73
	Choose image size and quality.
	White balance*  75
	Match white balance to the light source.
	Metering  77
	Choose the method used to control exposure.
	Continuous*  78
	Take pictures one at a time or in a sequence.
	BSS*  79
	Use the “best shot selector” to choose the sharpest picture.
	Color Options*  79
	Apply color effects to pictures as they are recorded.
	AF area mode  80
	Choose where the camera focuses.

* See the information on restrictions that may apply to [White balance], [Continuous], [BSS], and [Color Options] settings ( 81).

Displaying the Shooting Menu

Set the mode selector to  (auto) and press **MENU** to display the shooting menu.

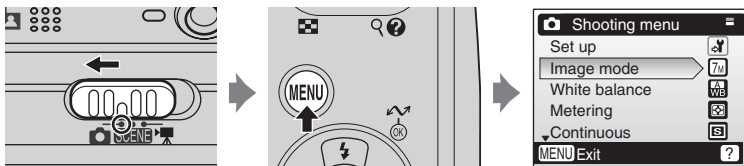





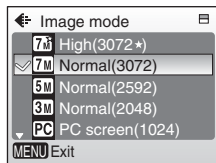

- To choose menus and apply selection, use the multi selector ( 8).
- To exit the shooting menu, press **MENU**.

Image Mode

Pictures taken with a digital camera are recorded as image files. The size of the files, and the number of images that can be recorded with it, depend on the size and quality of the images. Before shooting, choose an image mode according to how you plan to use the picture.



Option	Size (pixels)	Description
 High(3072★)	3,072 × 2,304	Highest quality, suitable for enlargements or high-quality prints.
 Normal(3072) (default setting)	3,072 × 2,304	Best choice in most situations.
 Normal(2592)	2,592 × 1,944	
 Normal(2048)	2,048 × 1,536	Smaller size allows more pictures to be stored.
 PC screen(1024)	1,024 × 768	Suited to display on computer display.
 TV screen(640)	640 × 480	Suited to full-screen display on a television or distribution by e-mail or the web.







The icon for the current setting is displayed in the monitor ( 6, 7).

Image Mode/Number of Exposures Remaining

The following table lists the number of pictures that can be stored in internal memory and on a 256 MB memory card, and the size of still pictures with it.

Image mode	Internal memory (8 MB)	Memory card (256 MB)	Print size (300 dpi; cm/in.)
 High(3072★)	2	70	26×19.5/10×7.7
 Normal(3072)	4	135	26×19.5/10×7.7
 Normal(2592)	6	190	22×16.5/8.7×6.5
 Normal(2048)	10	300	17×13/6.7×5
 PC screen(1024)	36	1025	9×7/3.5×2.5
 TV screen(640)	74	2200	5×4/2×1.5

* All figures are approximate. If the number of exposures remaining is 10,000 or more, the number of exposure remaining display shows [9999].

Image Mode

The image mode setting can also be applied from the one-touch portrait and scene menus. Changes made to the image mode setting from any of the three menus apply to all shooting modes.

WB White Balance

Adjust white balance based on the light source to give pictures the most realistic colors possible.

[Auto] can be used under most types of lighting, or you can apply the white balance setting suited to a particular light source to achieve more accurate results.

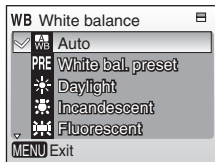

Auto (default setting)

White balance automatically adjusted to suit lighting conditions. Best choice in most situations.

White bal. preset

Neutral-colored object used as reference to set white balance under unusual lighting conditions ( 76).

Daylight

White balance adjusted for direct sunlight.

Incandescent

Use under incandescent lighting.

Fluorescent

Use under most types of fluorescent lighting.

Cloudy

Use when taking pictures under overcast skies.

Flash

Use with the flash.

At settings other than [Auto], the icon for the current setting is displayed in the monitor ( 6).

Notes on Flash Mode

At white balance settings other than [Auto] or [Flash], turn the flash off (  26).

PRE Preset White Balance

Preset white balance is used with mixed lighting or to compensate for light sources with a strong color cast (for example, to make pictures taken under a lamp with a red shade look as though they had been taken under white light).

1 Place white or gray reference object under the lighting that will be used during shooting.

2 Press the multi selector **▲** or **▼** to choose [White bal. preset] and press **OK**.

- The camera zooms in.
- For information on using the multi selector, see “Multi Selector” (8).

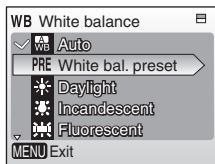

3 Press **▲** or **▼** to choose [Measure].

- To apply the most recently measured value for pre-set white balance, choose [Cancel] and press **OK**.

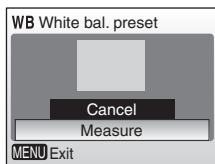

4 Frame the reference object.

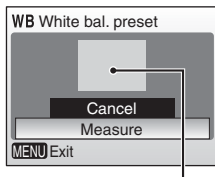

Reference object frame

5 Press **OK**.

- The shutter is released and the new white balance value is set.
- No pictures are recorded.

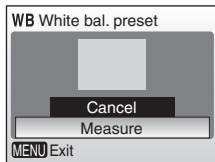

Notes on Preset White Balance

The camera cannot measure a value for preset white balance when the flash fires. Regardless of the flash mode selected, the flash will not fire when **OK** is pressed in step 5.

Metering

The camera's built-in metering system calculates the brightness of the subject to determine optimal exposure.

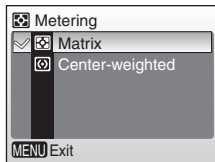

Matrix (default setting)

Analyzes the distribution of brightness over a wide area of the frame, producing optimal results for most situations.

Center-weighted

Meters the entire frame but assigns the greatest weight to the center area. Suitable for portraits. Reference circle for center-weighted metering appears in the monitor during shooting ( 6).

Continuous

Capture a fleeting expression on a portrait subject, photograph a subject that is moving unpredictably, or capture motion in a series of pictures. At setting other than [Single], focus, exposure compensation and white balance for all photos are determined by the first picture in each series.

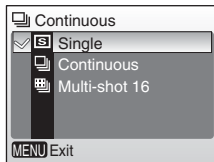

Single (default setting)

One shot is taken each time shutter-release button is pressed.

Continuous

While the shutter-release button is pressed, camera takes pictures continuously. COOLPIX L5 can take up to 0.7 frames per second at image-mode setting of [ Normal (3,072)].

Multi-shot 16

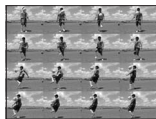

Each time the shutter-release button is pressed, camera takes 16 shots at about 5 frames per second and arrange them in a single picture ( Normal: 3,072 × 2,304 pixels) as shown at right.



The indicator for the current setting is displayed in the monitor ( 6). When [Single] is selected, no indicator is displayed in the monitor.

BSS

The “best shot selector” is recommended when shooting with the flash off or the camera zoomed in, or in other situations in which inadvertent motion can result in blurred pictures. When BSS is on, the camera takes up to ten pictures while the shutter-release button is held down. The sharpest picture in the series is saved and the others are discarded.

The  icon is displayed when BSS is on ( 6).

At default setting, BSS is [Off].

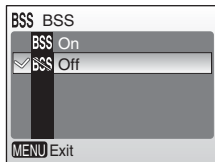

BSS

BSS may not produce the desired results if the subject moves or the composition changes during shooting.

Color Options

Make colors more vivid or record pictures in monochrome.

Standard color (default setting)

Use for pictures exhibiting natural color.

Vivid color

Use to achieve a vivid, “photoprint” colors.

Black-and-white

Record pictures in black-and-white.

Sepia

Record pictures in sepia tones.

Cyanotype

Record pictures in cyan-blue monochrome.

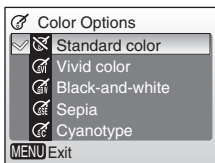

The effects of the selected option can be previewed in the monitor. At settings other than [Standard color], the icon for the current setting is displayed in the monitor ( 6).

[AF] AF Area Mode

Use this option to determine where the camera focuses.

[Auto] Auto (default setting)

Camera automatically selects the focus area (1 of 5;  6) containing the subject closest to the camera. The selected focus area is displayed when the shutter-release button is pressed halfway.

[Center] Center

Center focus area is used. This option can be used in combination with AF lock to keep off-center subjects in focus.

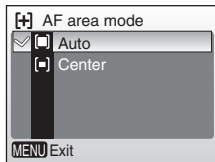

[AF-L] Focus Lock

To focus on off-center subjects when [Center] is selected for [AF area mode]:

1 Position the subject in the center of the frame.



2 Press the shutter-release button halfway.

- The focus indicator (AF ) and focus area turn green when the camera has focused on the subject.



3 Continue holding down the shutter-release button halfway and recompose the picture.

- Be sure that the distance between the camera and the subject does not change while focus is locked.



4 Press the shutter-release button the rest of the way down to take the picture.



[AF-ON] Autofocus

Autofocus may not perform as expected if the subject is very dark or moving rapidly; if there are objects of significantly differing levels of brightness in the scene (as when the sun is behind the subject, throwing their features into shadow); if the primary subject exhibits little contrast (as when the subject is generally the same color as the background); or if the scene contains several objects at differing distances from the camera (as when the primary subject is in a cage or behind a fence).

Restrictions on Camera Settings

Restrictions apply to the following settings in  mode:

Flash mode

Flash turns off at [Continuous] settings other than [Single] or when [BSS] is on. Applied setting is restored when [Single] is selected or [BSS] is turned off.

Self-timer

If self-timer is on, only one shot will be taken when shutter is released, regardless of settings chosen for [Continuous] and [BSS]. Applied [Continuous] and [BSS] setting is restored when picture is taken or self-timer is turned off.

Continuous

Selecting [Continuous] or [Multi-shot 16] turns [BSS] off. Applied [BSS] setting is not restored when [Single] is selected.

BSS

















[Continuous] is automatically set to [Single] when [BSS] is on. Applied [Continuous] setting is not restored when [BSS] is turned off.

White balance and color options

White balance is automatically set to [Auto] and cannot be adjusted when [Black-and-white], [Sepia], or [Cyanotype] is selected for [Color Options]. Applied white balance setting is restored when [Standard color] or [Vivid color] is selected.

Playback Options: The Playback Menu

The following options are available in the playback menu.

 Set up  88
Display the setup menu.
 Print set  70
Select pictures for printing.
 Slide show  84
View pictures in an automatic slide show.
 Delete  85
Delete all or selected pictures.
 Protect  85
Protect selected pictures from accidental deletion.
 Transfer marking  86
Change transfer marking for existing pictures.
 Small pic.  51
Create a small copy of the current picture.
 Copy  87
Copy files between the memory card and internal memory.

Displaying the Playback Menu

Display a picture by pressing  and press **MENU** to display the playback menu.

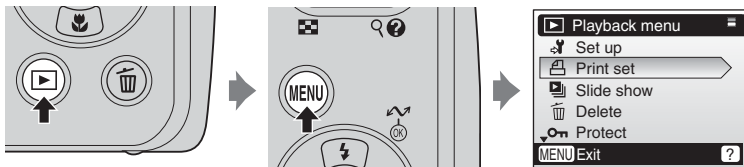

- To choose menus and apply selection, use the multi selector ( 8).
- To exit the playback menu, press **MENU**.

Navigating the Menus

Use the multi selector to navigate camera menus.

To select multiple pictures for a print set (☒ 70), deletion (☒ 85), protection from deletion (☒ 85), transfer (☒ 86), copying between internal memory and the memory card (☒ 87), or for the welcome screen (☒ 90):

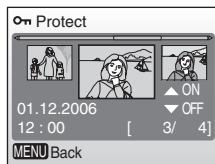

1 Press the multi selector ◀ or ▶ to choose a picture.

- The current picture is displayed at the center of the monitor.
- For information on using the multi selector, see "Multi Selector" (☒ 8).

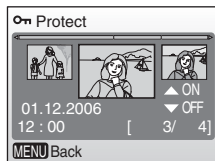

2 Press ▲ or ▼ to choose [ON] or [OFF] (or the number of copies when applying print settings).

- When [ON] is selected, the indicator for the specified function is displayed in the center of the current picture. Repeat steps 1 and 2 to select additional pictures.

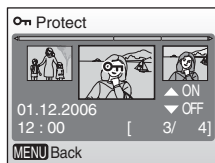

3 Press OK.

- The setting is enabled.

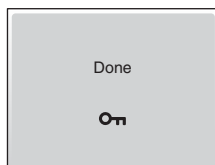

Slide Show

Play pictures back in an automated “slide show” with a three-second interval between pictures.

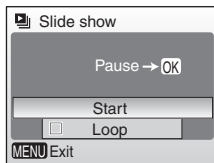

1 Press the multi selector ▲ or ▼ to choose [Start] and press **OK**.

- To repeat the slide show automatically, enable [Loop] and press **OK** before choosing [Start]. **✓** will be added to the loop option when enabled.
- For information on using the multi selector, see “Multi Selector” (8).

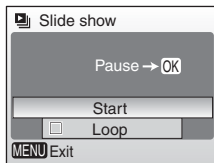

2 Slide show begins.

- Slide show begins.
- While the slide show is in progress, the following operations can be performed:
 - Press **▶** to skip to the next picture, or **◀** to return to the previous picture. Hold **◀** or **▶** down to fast forward or rewind.
 - Press **OK** to pause the slide show.
- The menu shown at right is displayed when the slide show ends or is paused. Choose [Restart] and press **OK** to play the slide show again, or choose [End] to stop the slide show and return to the playback menu.

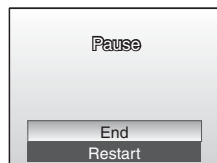

Notes on the Slide Show

- Only the first frame of movies (57) included in slide shows is displayed.
- Select [Loop] to repeat the slide show until **OK** is pressed. Note that the monitor will turn off automatically if no operations are performed for thirty minutes. The camera will turn off automatically if no operations are performed for another three minutes.

Delete

The delete menu contains the options shown below.

If no memory card is inserted in the camera, pictures in the internal memory will be deleted.

If a memory card is inserted, pictures on the memory card will be deleted.

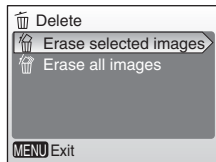



Erase selected images

Delete selected pictures.

See "Navigating the Menus" ( 83) for more information on using this function.

Erase all images

Delete all pictures stored in the internal memory or on the memory card.



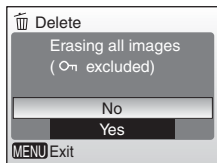

- Choose [Yes] and press  in the confirmation dialog to delete all pictures. To exit without deleting pictures, choose [NO] and press .





Notes on Deletion

- Once deleted, pictures cannot be recovered. Transfer important images to a computer before deletion.
- Pictures marked with the  icon are protected and cannot be deleted.

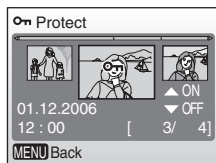

Protect

Protect selected pictures from accidental deletion. Protected pictures are recognized by the  icon ( 7) and cannot be deleted using  or the [Delete] option in the playback menu. Note, however, that formatting will delete protected files ( 98).



See "Navigating the Menus" ( 83) for more information on using this function.

Transfer Marking

When the camera is connected to a computer via the supplied USB cable and  (OK) is pressed to transfer pictures, only pictures marked with the  icon are transferred ( 62). At the default setting, all pictures are marked for transfer.

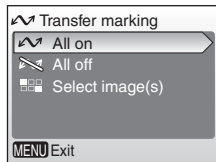

All on

Mark all images for transfer.



All off

Remove transfer marking from all images.

Select image(s)

Mark selected pictures for transfer.

See “Navigating the Menus” ( 83) for more information on using this function.

Pictures selected for transfer are recognized by the  icon ( 7).

Marking for Transfer

- No more than 999 pictures can be marked for transfer. If more than 999 pictures are marked, use PictureProject to transfer the pictures. See the PictureProject Reference Manual (on CD) for details.
- This camera cannot recognize the transfer settings for pictures applied with another make of camera. Use the COOLPIX L5 to select the pictures to transfer again.



Copy

Copy pictures between the internal memory and a memory card.

The options of this menu allows you to copy the specified pictures or all pictures in the internal memory or on the memory card.

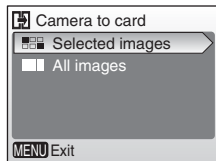
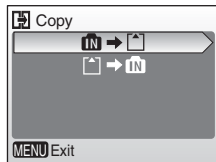
See “Navigating the Menus” ( 83) for more information on using the [Selected images] option.



	Copy pictures from internal memory to memory card.
	Copy pictures from memory card to internal memory.

Notes on Copying Pictures

- If there is not enough space in the memory or on the memory card to receive the copy, an error message will be displayed. Delete unwanted pictures or insert a new memory card (if using a memory card) before trying again.
- The file format of images that can be copied is JPEG, MOV, or WAV.
- The camera may be unable to copy pictures that were created with another make of camera or that have been modified on a computer.

File Number

- When pictures are copied using the [Selected images] option, the newly copied pictures are numbered consecutively from the largest number existing between the two memory sources.



Ex: when the last number in the source memory is 32 (DSCN0032.JPG) and the last number in the destination memory is 18 (DSCN0018.JPG).

The copied pictures are assigned numbers starting from DSCN0033.

After that, numbering will continue from the lowest number after the number of the last file that was copied.



























- When pictures are copied using the [All images] option, all the pictures in the folder are copied with the same file numbers. The newly copied folder is assigned the lowest available number.

Copies

Copies have the same protection marking as the original but are not marked for printing ( 70) or transfer ( 86).

Basic Camera Setup: The Setup Menu

The following options are available in the setup menu.

	Menus  89
	Choose how menus are displayed.
	Welcome screen  90
	Select screen displayed when camera is turned on.
	Date  91
	Set camera clock and choose home and destination time zones.
	Monitor settings  94
	Adjust monitor brightness and choose display style.
	Date imprint  95
	Imprint date or date counter on pictures.
	Sound settings  97
	Adjust sound and volume settings.
	Auto off  97
	Set time before camera enters standby mode to save power.
	Format memory/Format card  98
	Format internal memory or memory card.
	Language  99
	Choose language for camera menus and messages.
	Interface  99
	Adjust settings for connection to television or computer.
	Reset all  100
	Restore camera settings to default values.
	Battery Type  102
	Choose type of batteries inserted in camera.
	Firmware version  102
	Display camera firmware version.

Displaying the Setup Menu

Choose [Set up] in the shooting menu (📷 72), scene menu (📷 31), movie menu (📷 55), one-touch portrait menu (📷 46) or playback menu (📷 82) and press **OK** to display the setup menu.

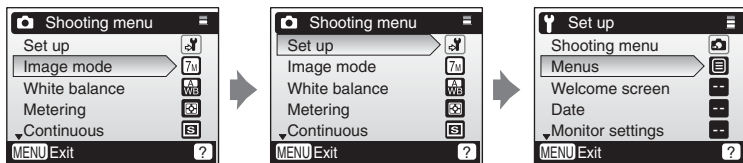

Displaying the menu screen

Press the multi selector **▲** or **▼** to choose [Set up] and press **OK**.

- To choose menus and apply selection, use the multi selector (📷 8).
- To exit the setup menu, press **MENU**.

MENU Menu

Choose whether the menu displayed when **MENU** is pressed use text or icons.

When [Icons] is selected, all menu items can be displayed with a single page and the name of the highlighted menu displayed at the top of the page.

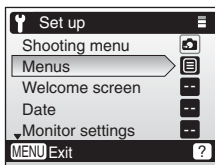
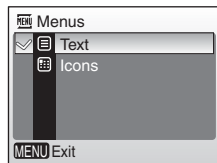

Text

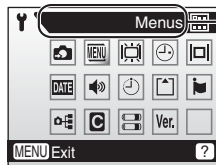

Icon

Menu names

Welcome Screen

You can select the welcome screen to be displayed when the camera is turned on.

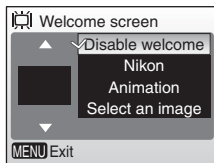

Disable welcome (default setting)

A welcome screen is not displayed when the camera is turned on.

Nikon

Displays a welcome screen when the camera is turned on.

Animation

Displays a short animation when the camera is turned on.

Select an image

Select a picture in the internal memory or on the memory card for the welcome screen.

See “Navigating the Menus” ( 83) for more information on using this function.

The image used in the welcome screen is a copy of the selected picture and, therefore, is not affected if the original picture is deleted or the memory card is removed.

When “Select an image” is Selected

If you have already selected a welcome screen picture, you can select a new one by following the confirmation dialog.

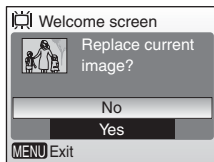

Date

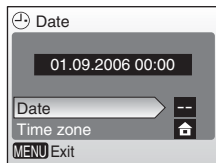

Set the camera clock and choose home and travel destination time zones.





Date

Set camera clock to current date and time ( 14-15).

Time zone





When  (destination time zone) is selected, the time difference ( 93) is automatically calculated and the date and time in the selected region are displayed. Home time zone and daylight saving time can be set in the time zone menu.

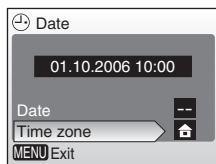

Setting Travel Destination Time Zone

1 Press the multi selector  or  to choose [Time zone] and press .

- The [Time zone] screen is displayed.
- For information on using the multi selector, see “Multi Selector” ( 8).



2 Press  or  to choose  and press .

- The date and time displayed on the monitor changes according to the region currently selected.
- If daylight saving time is in effect, press  to choose [DaylightSaving] and press  then press . The time is automatically advanced one hour.

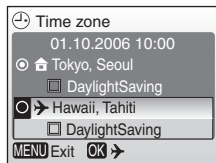

3 Press .

- The [New city time zone] screen is displayed.

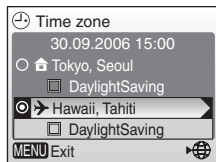

4 Press ◀ or ▶ to choose the travel destination time zone and press **OK**.

- The setting is enabled.



5 Press **MENU**.

- The camera returns to shooting mode or playback mode.
- While the travel destination time zone is selected, a ▶ icon will be displayed in the monitor when the camera is in shooting mode.

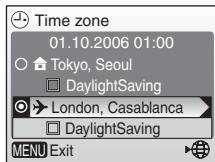

✓ The Clock Battery

The clock battery charges when the main batteries are installed or an AC adapter is connected, and can provide several days of backup power after about ten hours of charging.

🏠 (Home Time Zone)

- To switch to the home time zone, choose 🏠 in step 2 and press **OK**.
- To change the home time zone, choose 🏠 in step 2 and perform the following steps for the home time zone.

🕒 Daylight Saving Time

- If date and time are set when daylight saving time is not in effect:
Turn [DaylightSaving] on (✓) when daylight saving time begins to automatically advance the camera's clock one hour.
- If date and time are set with [DaylightSaving] turned on (✓) when daylight saving time is in effect:
Turn [DaylightSaving] off (✓) when daylight saving time ends to automatically set the camera's clock back one hour.

Time Zones

The camera supports the time zones listed below. Increments of less than one hour are not supported; when travelling to or from destinations at half- or quarter-hour increments from Greenwich Mean Time (GMT), such as Afghanistan, Central Australia, India, Iran, Nepal, or Newfoundland, set the camera clock to local time.

GMT +/-	Location	GMT +/-	Location
-11	Midway, Samoa	+1	Madrid, Paris, Berlin
-10	Hawaii, Tahiti	+2	Athens, Helsinki
-9	Alaska, Anchorage	+3	Moscow, Nairobi
-8	PST (PDT): Los Angeles, Seattle, Vancouver	+4	Abu Dhabi, Dubai
-7	MST (MDT): Denver, Phoenix, La Paz	+5	Islamabad, Karachi
-6	CST (CDT): Chicago, Houston, Mexico City	+6	Colombo, Dhaka
-5	EST (EDT): New York, Toronto, Lima	+7	Bangkok, Jakarta
-4	Caracas, Manaus	+8	Beijing, Hong Kong, Singapore
-3	Buenos Aires, São Paulo	+9	Tokyo, Seoul
-2	Fernando de Noronha	+10	Sydney, Guam
-1	Azores	+11	New Caledonia
±0	London, Casablanca	+12	Auckland, Fiji

Monitor Settings

The following options are available:

Photo info

Choose information displayed in the monitor.

Brightness

Choose from five settings for monitor brightness.

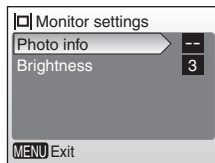

Photo Info

The following display options are available:

	Shooting mode	Playback mode
Show info (default setting)		
Auto info	The same information displayed when [Show info] is selected is shown, but icons are displayed for just 5 seconds.	
Hide info		
Framing grid	<p>Indicators are displayed in the monitor (6). In mode, framing grid is displayed to help frame pictures; and other indicators are displayed for 5 seconds.</p>	<p>The same information displayed when [Show info] is selected is shown, but icons are displayed for just 5 seconds.</p>

Photo Info

See “The Monitor” for information on indicators in the monitor (6).

Date Imprint

Date and time of recording can be imprinted on pictures for printing this information from printers that are not DPOF-compatible ( 117).

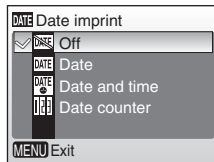

Off (default setting)

Time and date are not imprinted on pictures.

Date

Date is imprinted on the bottom right corner of pictures taken while this option is in effect.

Date and time

Date and time are imprinted on the bottom right corner of pictures taken while this option is in effect.



Date counter

 96



Time stamp shows number of days between date of recording and selected date.

At settings other than [Off], the option selected is recognized by an icon in the monitor during shooting ( 6).

Date Imprint

- Imprinted dates form a permanent part of image data and cannot be deleted.
- Dates imprinted at an image mode ( 73) setting of [TV screen(640)] may be difficult to read. Choose [PC screen(1024)] or larger when using date imprint.
- The date is recorded using the format selected in the [Date] item ( 14, 91).

[Date imprint] and [Print set]

When using DPOF-compatible devices, shooting date or photo information will be printed if [Date] or [Info] is selected in the print set menu ( 70). See "Differences Between Print Set and Date Imprint" ( 71) for more information on the difference between [Date imprint] and [Print set].

Date Counter

Pictures taken while this option is in effect are imprinted with the number of days remaining until, or the number of days elapsed since a specified date. Use it to track the growth of a child or count down the days until a birthday or wedding.

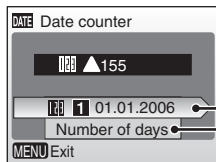

Press **OK** to display the stored dates option.

Press **OK** to display the display option.

Stored dates

Up to three dates can be stored. To set, highlight an option, press the multi selector **▶**, and enter a date (**02/ 15**). To select a date, choose an option and press **OK**.

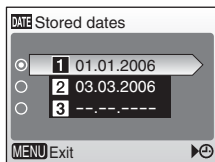

Display options

Choose [Number of days], [Years and days], or [Yrs, mnths, days] and press **OK**.

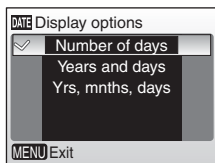

Sample date counter time stamps are shown below.



Two days remaining



Two days elapsed

🔊 Sound Settings

Adjust the following sound settings:

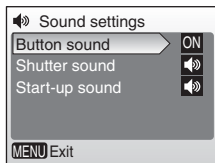

Button sound

When [On] (default setting) is selected, beep will sound once when operations are completed successfully, three times when error is detected.

Shutter sound

Choose volume of shutter sound from [Loud], [Normal] (default setting), and [Off].

Start-up sound

Choose volume of sound that plays when camera is turned on from [Loud], [Normal] (default setting), and [Off].

🕒 Auto Off

Choose the time allowed to elapse before the camera enters standby mode to save power. The camera will turn off automatically if no operations are performed for three minutes after entering standby mode.

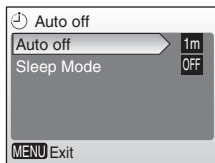

Auto off

Choose the time allowed to elapse before the camera enters standby mode when no operations are performed from [30s], [1m] (default setting), [5m], and [30m].

Sleep Mode

If [On] is selected, the camera will enter standby mode when there is no change in the brightness of the subject, even before the time selected in the auto off menu has elapsed.

The camera will enter sleep mode after 30 seconds when [Auto off] is set to [1m] or less, or after 1 minute when [Auto off] is set to [5m] or more.

☑️ Auto Off

Regardless of the option selected, the monitor will remain on for a minimum of three minutes when menus are displayed, and for thirty minutes during a slide show.

Format Memory/ Format Card

Use this option to format the internal memory or memory card.

Formatting the Internal Memory

To format the internal memory, remove the memory card from the camera.

The [Format memory] option appears in the setup menu.

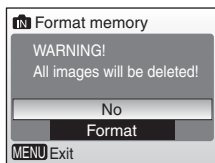

Formatting the Memory Card

When the memory card is inserted in the camera, the [Format card] option appears in the setup menu.

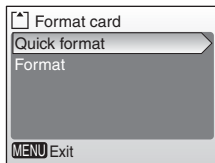

Quick format

Formats only portions of the memory card containing data.

Format

Formats the entire memory card including portions with no recorded data. Format takes longer than Quick format.

Formatting Internal Memory and Memory Cards

- Formatting the internal memory or memory cards permanently deletes all data. Be sure to transfer important pictures to a computer before formatting.
- Do not turn the camera off or remove the batteries or memory card during formatting.
- The first time you insert the memory cards used in other devices into the COOLPIX L5, format them with [Format].
- Repeated recording and deleting of pictures without regular formatting reduces memory card performance. Regular formatting of memory cards is recommended to maintain maximum performance.
- [Format] is not available when batteries are low.

🗨 Language

Choose one of twenty languages for display of camera menus and messages.

Čeština	Italiano	Svenska
Dansk	Nederlands	中文简体
Deutsch	Norsk	中文繁體
English	Polski	日本語
Español	Português	한글
Français	Русский	ภาษาไทย
Indonesia	Suomi	

Čeština	Czech
Dansk	Danish
Deutsch	German
English	English (default setting)
Español	Spanish
Français	French
Indonesia	Indonesian
Italiano	Italian
Nederlands	Dutch
Norsk	Norwegian

Polski	Polish
Português	Portuguese
Русский	Russian
Suomi	Finnish
Svenska	Swedish
中文简体	Simplified Chinese
中文繁體	Traditional Chinese
日本語	Japanese
한글	Korean
ภาษาไทย	Thai

🔌 Interface

Adjust settings for connection to a computer or video device.

USB

Select [Mass storage] or [PTP] for connection to computer (🔑 60) or printer (🔑 65).

Video mode

Choose from [NTSC] and [PAL].

Auto transfer

Choose [On] (default setting) to mark all new pictures for transfer to computer (🔑 63).

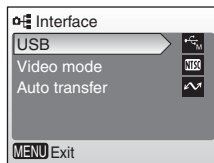





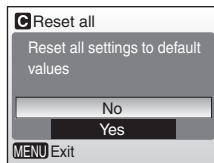

Reset All





This option restores the following settings to their default values:



Basic Photography

Vibration reduction ( 21)	VR (Normal)
Flash mode ( 26)	
Self-timer ( 28)	Off
Macro close-up ( 29)	Off
Exposure compensation ( 30)	0

Scene mode

Scene mode ( 31)	Portrait
Portrait assist ( 33)	Portrait
Landscape assist ( 34)	Landscape
Sports assist ( 35)	Sports
Night portrait assist ( 36)	Night portrait









One-touch portrait

Portrait effect ( 46)	Normal
---	--------

Movie menu

Movie options ( 55)	Small size 320
Auto-focus mode ( 55)	Single AF

Shooting menu

Image mode ( 73)	 Normal(3072)
White balance ( 75)	Auto
Metering ( 77)	Matrix
Continuous ( 78)	Single
BSS ( 79)	Off
Color options ( 79)	Standard color
AF area mode ( 80)	Auto

Setup menu

Menus (🔑 89)	Text
Welcome screen (🔑 90)	Disable welcome (off)
Photo info (🔑 94)	Show info
Brightness (🔑 94)	3
Date imprint (🔑 95)	Off
Button sound (🔑 97)	On
Shutter sound (🔑 97)	Normal
Start-up sound (🔑 97)	Normal
Auto off (🔑 97)	1 m (one minutes)
Sleep mode (🔑 97)	Off
Auto transfer (🔑 99)	On

Others

Paper size (🔑 66, 🔑 68)	Default
--------------------------------	---------

- Choosing [Reset] also clears the current file number (🔑 104) from memory. Numbering will continue from the lowest number available. To reset file numbering to “0001,” delete all pictures (🔑 85) before selecting [Reset].
- All other settings, including [Date] (🔑 91), [Date counter] (🔑 96), [Language] (🔑 99), [USB], and [Video mode] in the [Interface] menu (🔑 99), and [Battery Type] (🔑 102) remain unaffected.

Battery Type

To ensure that the camera shows the correct battery level ( 18), choose the type that matches the batteries currently in use.

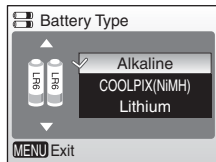

Alkaline (default setting)	LR6 alkaline batteries
COOLPIX (NiMH)	Nikon EN-MH1 rechargeable nickel-metal hydride batteries ZR6 oxyride batteries
Lithium	FR6/L91 lithium batteries

Firmware Version

View the current camera firmware version.

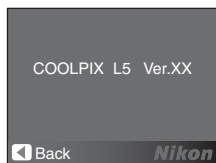

Optional Accessories

Rechargeable battery

Two Nikon EN-MH1 rechargeable NiMH batteries (EN-MH1-B2)

Battery charger

MH-71 battery charger

AC adapter

EH-65A AC adapter kit (connects as shown)

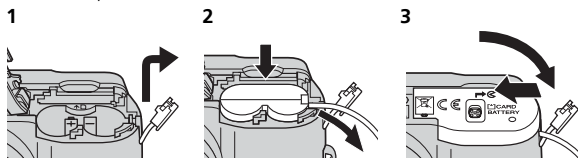

EH-62B AC adapter kit cannot be used.

Approved Memory Cards

The following memory cards have been tested and approved for use in the COOLPIX L5:

SanDisk

64 MB, 128 MB, 256 MB, 512 MB, 1 GB, 256 MB*, 512 MB*, 1 GB*

Toshiba

64 MB, 128 MB, 256 MB, 512 MB, 1 GB, 128 MB*, 256 MB*, 512 MB*

Panasonic

64 MB, 128 MB, 256 MB, 512 MB, 1 GB, 256 MB*, 512 MB*, 1 GB*

* Cards rated for 10 MB/s (high speed)

Other memory cards have not been tested. For more details on the memory cards listed above, please contact the manufacturer.



Image File and Folder Names

Pictures, movies, and voice memos are assigned file names with three parts: a four letter identifier, a four-digit file number assigned automatically by the camera in ascending order, and a three-letter extension (e.g., "DSCN0001.JPG").

Originals	Identifier*	Extension
Still picture	DSCN	.JPG
Movie	DSCN	.MOV
Voice memo	DSCN	.WAV

Copies	Identifier*	Extension
Cropped copy	RSCN	.JPG
Small copy	SSCN	.JPG
D-Lighting copy	FSCN	.JPG
Voice memo	Same as picture	.WAV

* The identifier is not displayed, but is visible when the picture is transferred to a computer.

Pictures are stored in folders named with a three-digit folder number followed by a five-character identifier: "P_" plus a three-digit sequence number for pictures taken using panorama assist (e.g., "101P_001";  42) and "NIKON" for all other pictures (e.g., "100NIKON"). Folders can hold up to 200 pictures; if a picture is taken when the current folder contains 200 pictures, a new folder will be created by adding one to the current folder number. If a picture is taken when the current folder is numbered 999 and contains 200 pictures or a picture numbered 9999, no further pictures can be taken until the medium is formatted ( 98) or a new memory card inserted.

Caring for the Camera

To ensure continued enjoyment of this Nikon product, observe the following precautions when using or storing the device.

✔ Handle the lens and all moving parts with care

Do not apply force to the lens, lens cover, monitor, memory card slot, or battery chamber. These parts are easily damaged. Applying force to the lens cover could result in camera malfunction or damage to the lens. Should the monitor break, care should be taken to avoid injury caused by broken glass and to prevent the liquid crystal from the display touching the skin or entering the eyes or mouth.

✔ Do not point the lens at strong light sources for extended periods

Avoid pointing the lens at the sun or other strong light sources for extended periods when using or storing the camera. Intense light may cause deterioration of the CCD image sensor, producing a white blur effect in photographs.

✔ Turn the product off before removing or disconnecting the power source

Do not unplug the product or remove the batteries while the product is on, or while images are being recorded or deleted. Forcibly cutting power in these circumstances could result in loss of data or in damage to product memory or internal circuitry. To prevent an accidental interruption of power, avoid carrying the product from one place to another while an AC adapter is connected.

✔ Keep dry

The device will be damaged if immersed in water or subjected to high humidity.

✔ Do not drop

The product may malfunction if subjected to strong shock or vibration.

✔ Keep away from strong magnetic fields

Do not use or store this device in the vicinity of equipment that generates strong electromagnetic radiation or magnetic fields. Strong static charges or the magnetic fields produced by equipment such as radio transmitters could interfere with the monitor, damage data stored on the memory card, or affect the product's internal circuitry.

✔ Avoid sudden changes in temperature

Sudden changes in temperature, such as occur when entering or leaving a heated building on a cold day, can cause condensation to form inside the device. To prevent condensation, place the device in a carrying case or a plastic bag before exposing it to sudden changes in temperature.

Caring for the Camera

Batteries

- Check the battery level when taking the camera out and replace the batteries if necessary (🔋 18). If possible, carry spare batteries when taking pictures on important occasions.
- Battery capacity tends to decrease on cold days. Be sure that the batteries are fresh before heading outside to take pictures in cold weather. Keep spare batteries in a warm place and exchange as necessary. Once warmed, a cold battery may recover some of its charge.
- Dirt on the battery terminals can prevent the camera from functioning.
- Used batteries are a valuable resource. Please recycle used batteries in accordance with local regulations.

Cleaning

Lens

Avoid touching glass parts with your fingers. Remove dust or lint with a blower (typically a small device with a rubber bulb attached to one end that is pumped to produce a stream of air out the other end). To remove fingerprints or other stains that cannot be removed with a blower, wipe the lens with a soft cloth, using a spiral motion that starts at the center of the lens and working toward to the edges. If this fails, clean the lens using a cloth lightly dampened with commercial lens cleaner.

Monitor

Remove dust or lint with a blower. To remove fingerprints and other stains, clean the monitor with a soft, dry cloth, being careful not to apply pressure.

Body

Use a blower to remove dust, dirt, or sand then wipe gently with a soft, dry cloth. After using the camera at the beach or seaside, wipe off any sand or salt with a dry cloth lightly dampened with fresh water, then dry thoroughly. Note that foreign matter inside the camera could cause damage not covered by the warranty.

Do not use alcohol, thinner, or other volatile chemicals.

Storage

Turn the camera off when not in use. Check that the power-on lamp is off before putting the camera away. Remove the batteries if the camera will not be used for an extended period. Do not store the camera with naphtha or camphor moth balls or in locations that:

- are next to equipment that produces strong electromagnetic fields, such as televisions or radios
- are exposed to temperatures below -10°C (14°F) or above 50°C (122°F)
- are poorly ventilated or subject to humidities of over 60%













To prevent mold or mildew, take the camera out of storage at least once a month. Turn the camera on and release the shutter a few times before putting the camera away again.









Notes on the Monitor

- The monitor may contain a few pixels that are always lit or that do not light. This is a characteristic common to all TFT LCD displays, and does not indicate a malfunction. Images recorded using the product will not be affected.
- When framing bright subjects, vertical comet-like streaks that whiten toward either end may appear in the display. This phenomenon, known as “smear,” does not appear in the final photograph and does not indicate a malfunction. Some smear may appear in movies.
- Images in the monitor may be difficult to see under bright lighting.
- The monitor is lit by an LED backlight. Should the monitor begin to dim or flicker, contact your Nikon service representative.







Error Messages

The following table lists the error messages and other warnings displayed in the monitor, as well as the solutions for dealing with them.

Display	Problem	Solution	
 (blinks)	Clock not set.	Set clock.	91
	Batteries running low.	Ready spare batteries.	10, 102
Warning!! Battery exhausted 	Batteries exhausted.	Replace batteries.	
 ● (● blinks red)	Camera cannot focus.	Recompose picture.	22, 80
Warning!! please wait for the camera to finish recording 	Camera cannot perform other operations until recording is complete.	Message clears from dis- play automatically when recording is complete.	—
Memory card is write protected 	Write-protect switch is in “lock” position.	Slide write-protect to “write” position.	17
This card cannot be used 	Error accessing memory card.	<ul style="list-style-type: none"> • Use approved card. • Check that connectors are clean. • Confirm that memory card is correctly inserted. 	103
Warning!! This card cannot be read 			16
 Card is not format- ted Format No	Memory card has not been formatted for use in camera.	Highlight [Format] and press  to format card, or turn camera off and replace card.	17
Out of memory  or 	Memory card is full.	<ul style="list-style-type: none"> • Choose smaller image size. • Delete pictures or voice memos. • Insert new memory card or remove memory card and use internal memory. 	31, 46, 73 24, 53, 85 16, 17



Display	Problem	Solution	
Image cannot be saved  or 	Error occurred while recording picture.	Format internal memory or memory card.	98
	Camera has run out of file numbers.	<ul style="list-style-type: none"> • Insert new memory card. • Format internal memory or memory card. 	16 98
	Cannot create cropped, D-Lighting, or small copy.	Select picture that supports crop, D-Lighting, or small picture.	52
	Picture cannot be used for welcome screen.	Choose picture 640 × 480 pixels or larger.	—
	Cannot copy picture.	Delete pictures from destination.	85
Image has already been modified. D-Lighting cannot be used. 	Image can not be enhanced using D-Lighting.	Copies from D-Lighting, crop, or small picture option can not be adjusted using D-Lighting.	52
Cannot record movie	Time out error while recording movie.	Choose memory card with faster write speed.	103
Memory contains no images 	No pictures available for playback.	—	—
File contains no image data 	File not created with COOLPIX L5.	View file on computer or other device.	—
This image cannot be deleted 	Picture is protected.	Remove protection.	85
New city is in the current time zone 	Destination in same time zone as home.	No need to change time zones if destination is in same time zone as home.	93
Lens error 	Lens error.	Turn camera off and then on again. If error persists, contact retailer or Nikon representative.	12

Error Messages













Display	Problem	Solution	
Communications error 	USB cable disconnected during transfer or printing.	If PictureProject displays error in the monitor of the computer, click [OK] to exit. Resume operation after turning camera off and reconnecting cable. When the camera is connected to a printer, refer to the instructions of the printer.	62, 65
	[USB] option incorrect.	Choose correct [USB] option.	60, 61
	PictureProject did not start.	—	—
No images are marked for transfer 	No pictures selected for transfer.	Select pictures for transfer in the playback menu and try again.	63, 86
Transfer error 	Transfer error.	<ul style="list-style-type: none"> • Check battery level. • Check that USB cable is connected. 	18 60
System error 	Error has occurred in camera's internal circuitry.	Turn camera off, remove and reinsert batteries, and turn camera on. If error persists, contact retailer or Nikon representative.	12
Printer error check printer status 	Running out of ink or printer error.	Check printer. Replace ink cartridge with new one.	—







Troubleshooting

If the camera fails to function as expected, check the list of common problems below before consulting your retailer or Nikon representative. Refer to the page numbers in the right-most column for more information.

Problem	Cause/Solution	
Camera turns off without warning	<ul style="list-style-type: none"> Batteries are low. Batteries are cold. 	18 106
Monitor is blank	<ul style="list-style-type: none"> Camera is off. Batteries are exhausted. Standby mode for saving power. Press the shutter-release button halfway. Flash lamp blinks: wait until flash has charged. USB cable is connected. AV cable is connected. 	12 18 13, 23 27 60 59
No indicators displayed in monitor	[Hide info] is selected for [Photo info]. Select [Show info].	94
Monitor is hard to read	<ul style="list-style-type: none"> Adjust monitor brightness. Monitor is dirty. Clean monitor. Monitor brightness at 50% to save power. 	94 106 13
Camera clock is not correct	Pictures recorded before clock has been set will have time stamp of "00.00.0000 00:00"; movies will be dated "01.09.2006 00:00." Set the correct date and time from [Date] in the setup menu.	14, 91
Camera settings reset	Clock battery exhausted. Charge clock battery.	92
No picture taken when shutter-release button is pressed	<ul style="list-style-type: none"> Camera is in playback mode: press . Menus are displayed: press MENU. Batteries are exhausted. Flash lamp blinks: flash is charging. 	24 9 18 27

Troubleshooting

Problem	Cause/Solution	
Camera cannot focus using auto-focus	<ul style="list-style-type: none"> • Subject is low in contrast, dominated by repeating geometric patterns, covers too small an area of the frame, or contains many fine details, objects of sharply differing brightness, or objects at different distances from the camera. Use focus lock to focus on another subject at same distance. 	80
	<ul style="list-style-type: none"> • Focus error. Turn camera off and then on again. 	12
Pictures are blurred	<ul style="list-style-type: none"> • Use flash. • Use vibration reduction. • Use . • Use tripod and self-timer. 	26 21 79 5, 28
Pictures are too dark (underexposed)	<ul style="list-style-type: none"> • Flash is off. • Flash window is blocked. • Subject is beyond flash range. • Adjust exposure compensation. • Subject is backlit. Select  ([Back light] scene mode) or use fill flash. 	26 20 26 30 26, 41
Pictures are too bright (overexposed)	Adjust exposure compensation.	30
Randomly-spaced bright pixels ("noise") appear in image	Shutter speed too slow. Noise can be reduced by: <ul style="list-style-type: none"> • Using flash • Choosing , , , , , , , , or  scene mode 	26 36, 39
Pictures appear smeared	Lens is dirty. Clean lens.	106
Colors are unnatural	White balance does not match light source.	75
Flash does not fire	Flash is off. Note that flash turns off automatically in  mode and some scene modes, or when option other than [Single] is selected for [Continuous], or [BSS] is on.	26 32, 37 54 78, 79, 81

Problem	Cause/Solution	
Portions of pictures not related to the “red eye” phenomenon are affected	In-camera red-eye fix may, in very rare circumstances, be applied to areas of pictures not affected by “red eye” when pictures are taken in  (auto with red-eye reduction) flash mode, one-touch portrait mode, or [ portrait] or [ Night portrait] scene assist modes. Use a different shooting mode or set flash to  (auto) or  (fill flash).	26, 31, 33, 44
Bright specks appear in pictures taken with flash	Flash is reflecting off particles in air. Turn flash off.	26
No sound when shutter is released	[Off] selected for [Sound settings]>[Shutter sound] in the setup menu.	97
Optical zoom cannot be used	Optical zoom cannot be used while recording movies.	54
Digital zoom cannot be used	Digital zoom is not available in scene assist modes or when option other than [Single] is selected for [Continuous].	31, 78
[Image mode] not available	[Image mode] cannot be adjusted when [Multi-shot 16] is selected for [Continuous] or [Sports composite] is selected in sports assist mode.	35, 78
[Date imprint] not available	Camera clock has not been set.	14, 91
Date not appearing on pictures	Date does not appear on movies or on pictures taken using panorama assist.	42, 54
File cannot be played back	File has been overwritten or renamed by computer or other make of camera.	—
Cannot zoom in on picture	Playback zoom cannot be used with movies, small pictures, or pictures that have been cropped to below 320 × 240.	—
Cannot record voice memo	Voice memos cannot be appended to movies.	57
Cannot mark pictures for transfer	No more than 999 pictures can be marked for transfer. Use PictureProject [Transfer] button to transfer pictures.	62
Transfer marking does not appear	Pictures were marked for transfer using another model of camera. Mark pictures for transfer using COOLPIX L5.	63, 86

Problem	Cause/Solution	
PictureProject does not start when camera is connected	<ul style="list-style-type: none"> • Camera is off. • Batteries are exhausted. • USB cable is not correctly connected. • Appropriate [USB] option is not selected. • Camera is not registered in Device Manager (Windows only). See the <i>PictureProject reference manual</i> (on CD) for further information. • Computer is not set to launch PictureProject automatically. 	12 18 62 60, 61 — —
Pictures not displayed on television	Choose correct video mode.	99
[Format memory]>[Format] option not available	Batteries are low.	18, 98

Electronically Controlled Cameras

In extremely rare instances, unusual characters may appear in the monitor and the camera may stop functioning. In most cases, this phenomenon is caused by a strong external static charge. Turn the camera off, remove and replace the batteries, and then turn the camera on again. In the event of continued malfunction, contact your retailer or Nikon representative. Note that disconnecting the power source as described above may result in the loss of any data not recorded to internal memory or the memory card at the time the problem occurred. Data already recorded will not be affected.

Specifications

Nikon COOLPIX L5 Digital Camera

Type	Compact digital camera
Effective pixels	7.2 million
CCD	1/2.5-in. CCD; total pixels: 7.41 million
Image size (pixels)	<ul style="list-style-type: none">• 3,072 × 2,304 [High(3072★)/Normal(3072)]• 2,592 × 1,944 [Normal(2592)]• 2,048 × 1,536 [Normal(2048)]• 1,024 × 768 [PC screen(1024)]• 640 × 480 [TV screen(640)]
Lens	5× Zoom-Nikkor lens
Focal length	F=6.3–31.4 mm (35-mm [135] camera-format equivalent: 38–190 mm)
f/-number	f/2.9–f/5.0
Construction	nine elements in seven groups
Digital zoom	Up to 4× (35-mm [135] camera-format equivalent: 760 mm)
Autofocus (AF)	Contrast-detect AF
Focus range (from lens)	W: 50 cm (1 ft. 7.7 in.) – ∞ T: 1 m (3 ft. 3.4 in.) – ∞ Macro close-up mode: 4 cm (1.6 in.) – ∞(W)
Focus-area selection	Center, Auto (five-area automatic selection)
Vibration reduction	Lens shift
Monitor	2.5 in., 115,000-dot, TFT LCD with brightness adjustment
Frame coverage	Shooting mode: Approximately 98% horizontal and 98% vertical Playback: Approximately 100% horizontal and 100% vertical
Storage	
Media	Internal memory (approx. 8 MB); Secure Digital (SD) memory cards
File system	DCF, Exif 2.2, and DPOF compliant
File formats	Compressed: JPEG-baseline-compliant Movies: QuickTime, Audio files: WAV
Exposure	
Metering	Matrix, center-weighted
Exposure control	Programmed auto exposure with exposure compensation (–2.0–+2.0 EV in steps of 1/3 EV)
Range	W: +1.1–+15.8 EV, T: +2.6–+17.4 EV

Specifications

Shutter	Mechanical and charge-coupled electronic shutter
Speed	4– ¹ /2000 s
Aperture	Electronically controlled preset aperture
Range	Two steps (f/2.9 and f/4.9 [W])
ISO sensitivity	Approximately equivalent to ISO 80 (auto gain to ISO 400 equivalent)
Self-timer	Ten-second duration
Built-in flash	
Range	W: 0.5–5.5 m/1 ft. 7.7 in. –18 ft. 0.5 in. T: 0.6–4 m/1 ft. 12 in. –13 ft. 1.8 in.
Flash control	Sensor flash system
Interface	USB
Video output	Can be selected from NTSC and PAL
I/O terminals	Audio/video (A/V) out, digital I/O (USB)
Supported languages	Czech, Danish, German, English, Spanish, French, Indonesian, Italian, Dutch, Norwegian, Polish, Portuguese, Russian, Finnish, Swedish, Chinese (Simplified and Traditional), Japanese, Korean, Thai
Power sources	<ul style="list-style-type: none">• Two AA alkaline, oxyride, or lithium batteries• Two EN-MH1 rechargeable NiMH batteries• EH-65A AC adapter kit
Battery life	Approximately 150 shots with alkaline, 490 shots with lithium, or 250 shots with EN-MH1 batteries*
Dimensions (W × H × D)	97 × 61 × 45 mm/3.8 × 2.4 × 1.8 in. (excluding projections)
Weight	170 g (6.0 oz.) without battery or memory card
Operating environment	
Temperature	0–+40 °C (+32–104 °F)
Humidity	Less than 85% (no condensation)

* Based on Camera and Imaging Products Association (CIPA) standards for measuring the life of camera batteries. Measured at 25 °C (77 °F); zoom adjusted with each shot, flash fired with every other shot, image mode set to [ Normal(3072)]. Battery life may vary depending on shooting interval and length of time menus and images being displayed.

Unless otherwise stated, all figures are for a camera with fully charged EN-MH1 batteries operated at an ambient temperature of 25 °C (77 °F).

MH-71 Battery Charger

Rated input	AC 100–240 V, 0.11–0.065 A, 50/60 Hz
Charging output	DC 1.2 V/2000 mA
Supported batteries	Nikon EN-MH1 rechargeable Ni-MH batteries
Discharge time	Approximately 5 hours
Charging time	Approximately 2.5 hours
Operating temperatures	5–35 °C (+41–95 °F)
Dimensions (W × H × D)	70 × 79 × 30 mm/2.8 × 3.1 × 1.2 in.
Length of cord	Approximately 1800 mm (70.9 in.)
Weight	110 g (3.9 oz.), excluding power cable

Supported Standards

- **DCF:** Design Rule for Camera File System is a standard widely used in the digital camera industry to ensure compatibility among different makes of camera.
- **DPOF:** Digital Print Order Format is an industry-wide standard that allows pictures to be printed from print orders stored on the memory card.
- **Exif version 2.2:** This camera supports Exif (Exchangeable Image File Format for Digital Still Cameras) version 2.2, a standard that allows information stored with photographs to be used for optimal color reproduction when images are output from Exif-compliant printers.
- **PictBridge:** A standard developed cooperatively by the digital camera and printer industries, allowing photographs to be output directly to a printer without connecting the camera to a computer.

Specifications

Nikon will not be held liable for any errors this manual may contain. The appearance of this product and its specifications are subject to change without notice.

EN-MH1 NiMH Batteries

The capacity of NiMH batteries will drop if they are charged repeatedly without first being fully discharged. The batteries will regain normal capacity once fully discharged. Note that NiMH batteries gradually lose their charge when not in use; refresh the batteries immediately before use.

Index

Symbols

- W** (☒) button 20, 29
- ☒ (**W**) button 47, 48, 49
- T** (Q) button 20, 29
- Q (**T**) button 47, 48, 49
- T** (⊙) button 9
- MENU** button 5, 9, 89
- ⊙ button 5, 8
- ⚡ (flash) button 5, 26
- ⌚ (self-timer) button 5, 28
- 🌸 (macro close-up) button 5, 29
- ☒ (exposure compensation) button 5, 30
- ▶ (playback) button 5, 24, 59
- 🗑️ (delete) button 5, 24, 57
- 👤 (one-touch portrait) button 4, 44
- ☒ (D-lighting) button 50
- ☒ (D-lighting) button 4
- VR** (vibration reduction) button 4, 21
- 📷 (auto) mode 8, 18
- SCENE** (scene) mode 8, 31, 32
 - scene assist modes 32
 - scene modes 37
- 🎬 (movie) mode 8, 54, 56
- 🏞️ landscape assist 34
- 🌃 night portrait assist 36
- 👤 portrait assist 33
- 🏃 sports assist 35

A

- AC adapter 13, 58, 103
- AF area mode 80
- Audio/video (A/V) cable (EG-CP14) 59
- Auto off 13, 97
- Auto transfer 99
- Auto-focus mode 55
 - full-time AF 55
 - single AF 55

B

- Back light 41

- Batteries 5, 10, 12, 102
 - charger 103
 - EN-MH1 10, 11, 12, 102, 103
 - FR6/L91 (AA) 12, 102
 - LR6 (AA) 12, 13, 102
 - ZR6 (AA) 12, 102

- Battery level 18
- Battery type 13, 102
- Battery-chamber cover 5
- Beach/snow 38
- Best shot selector 79
- Brightness 94
- BSS 79

C

- Cable connector 5, 62, 65
- Cleaning 106
 - body 106
 - lens 106
 - monitor 106
- Close up 40
- Color options 79
- Computer, connecting to 60
- Continuous 78
- Copy 41
 - copying pictures to 87
- Crop 49

D

- Date 14, 91
- Date counter 96
- Date imprint 95
- Daylight saving time 14, 15, 92
- DCF 117
- Delete 85
- Digital print order format 70, 117
- D-Lighting 50
- DPOF 70, 117
- DPOF printing 68
- Dusk/dawn 39

E

- Editing pictures 49
 - creating a cropped copy 49
 - enhancing contrast 50
 - resizing pictures 51
- EH-65A 58, 103
- Exif version 2.2 117
- Exposure compensation 30

F

- Face-priority AF 45
- File names 104
- Fireworks show 40
- Firmware version 102
- Flash 4, 26
 - lamp 27
 - mode 26
- Flash lamp 5
- Focus 22, 23
- Focus area 6, 22
- Focus lock 80
- Folder names 104
- Formatting
 - internal memory 98
 - memory cards 17, 98
- Framing pictures 20

H

- Help 9

I

- Identifier 104
- Image mode 19, 31, 73
- Image quality 73
- Image size 73
- Interface 99
- Internal memory 16
 - formatting 98
- ISO 27

J

- JPG 104

L

- Lamp, red 27
- Language 99
- Lens 4

M

- Macro close-up mode 29
- Memory cards 5, 16, 103
 - capacity 18
 - formatting 17, 98
- Menus, text or icons 89
- Metering 77
- Microphone 4, 53
- Mode selector 5, 8
- Monitor 5, 6
- Monitor settings 94
- MOV 104
- Movie menu 55
- Movie mode 54
- Movie options 55
 - maximum movie length 55
 - small size 55
 - smaller size 55
 - TV movie 55
- Movies
 - playback 57
 - recording 54
- Multi selector 5, 8
- Museum 40

N

- Night landscape 39
- NTSC 99
- Number of exposures remaining 18, 74

O

- On 14, 18
- One-touch portrait menu 46
 - image mode 46
 - portrait effect 46
- One-touch portrait mode 44

Index

P

- PAL 99
- Panorama assist 41, 42
 - AE-L 43
- Paper size 66, 68
- Party/indoor 38
- PictBridge 64, 117
- Playback
 - full-frame playback 24, 25
 - thumbnail playback 47
 - viewing pictures 25
- Playback menu 82
- Power saving 13
- Power switch 4, 12
- Power-on lamp 4, 12
- Print set 70
 - printing date 71
 - shooting information 71
- Printing pictures 64, 66, 67
 - direct printing 64
- Protect 85

R

- Red-eye reduction 27
- Reset all 100

S

- Self-timer 28
- Self-timer lamp 4
- Setup menu 88
- Shooting menu 72
- Shutter-release button 4, 22, 23
- Slide show 84
- Small picture 51
- Sound settings 97
- Speaker 4
- Standby mode 13
- Strap, camera 4
- Sunset 38

T

- Television 59
 - connecting to 59
- Time zone 14, 91
 - time zone list 93
- Transfer
 - marking pictures for, 63
- Transfer marking 86, 99
- Transferring pictures 62
- Tripod 5, 36, 39

U

- USB 61, 63, 65, 99
 - cable (UC-E6) 60, 62, 63

V

- Vibration reduction (**VR**) 21
- Video mode 99
- Voice memos 53
- Volume 53, 57

W

- WAV 104
- Welcome screen 90
- White balance 75

Z

- Zoom 20
 - digital 20, 21
 - optical 20
 - playback 48
- Zoom buttons 5, 57



A series of ten horizontal dashed lines, evenly spaced, intended for handwriting practice.

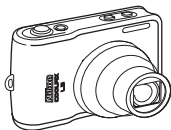

Two horizontal dashed lines, one above and one below the camera illustration, intended for handwriting practice.



A series of horizontal dashed lines for handwriting practice, consisting of 15 lines spaced evenly down the page.

Handwriting practice lines consisting of 15 sets of horizontal dashed lines.



Nikon

No reproduction in any form of this manual, in whole or in part (except for brief quotation in critical articles or reviews), may be made without written authorization from NIKON CORPORATION.