

Nikon

DIGITAL CAMERA

COOLPIX L28

Reference Manual



En



Feature Highlights of the COOLPIX L28

Let your camera take over

(Easy Auto) Mode **32**

When you aim the camera at your subject, the camera selects the appropriate settings for you. It's easy to take pictures in situations that normally require difficult settings, such as when shooting with backlighting or shooting at night. Simply press the shutter-release button to capture beautiful shots quickly and easily.

Capture perfect portraits

Smart Portrait Mode **39**

This mode is perfect for portraits and group shots.

When you aim the camera at a person, the camera focuses automatically on that person's face. With options like **Smile timer**, which captures images automatically when your subject smiles, and **Skin softening**, which makes facial skin tones appear smoother, you'll capture vibrant shots of your subjects every time.

Introduction

Parts of the Camera

The Basics of Shooting and Playback

Shooting Features

Playback Features

Recording and Playing Back Movies

General Camera Setup

Reference Section

Technical Notes and Index

Read This First

Thank you for purchasing the Nikon COOLPIX L28 digital camera. Before using the camera, please read the information in “For Your Safety” (📖 x) and familiarize yourself with the information provided in this manual. After reading, please keep this manual handy and refer to it to enhance your enjoyment of your new camera.

Attaching the Camera Strap

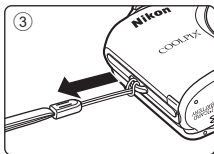
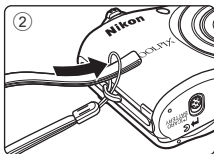
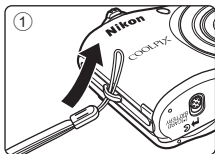

About This Manual





If you want to start using the camera right away, see “The Basics of Shooting and Playback” (📖 9).

To learn about the parts of the camera and information that is displayed in the monitor, see “Parts of the Camera” (📖 1).

Other Information

- Symbols and Conventions

To make it easier to find the information you need, the following symbols and conventions are used in this manual:

Icon	Description
	This icon indicates cautions and information that should be read before using the camera.
	This icon indicates notes and information that should be read before using the camera.
	These icons indicate other pages containing relevant information;  : "Reference Section",  : "Technical Notes and Index."

- SD, SDHC, and SDXC memory cards are referred to as "memory cards" in this manual.
- The setting at the time of purchase is referred to as the "default setting."
- The names of menu items displayed in the camera monitor, and the names of buttons or messages displayed on a computer monitor appear in bold.
- In this manual, images are sometimes omitted from monitor display samples so that monitor indicators can be more clearly shown.
- Illustrations and monitor content shown in this manual may differ from the actual product.

Information and Precautions

Life-Long Learning

As part of Nikon's "Life-Long Learning" commitment to ongoing product support and education, continually updated information is available online at the following sites:

- For users in the U.S.A.: <http://www.nikonusa.com/>
- For users in Europe and Africa: <http://www.europe-nikon.com/support/>
- For users in Asia, Oceania, and the Middle East: <http://www.nikon-asia.com/>

Visit these sites to keep up-to-date with the latest product information, tips, answers to frequently asked questions (FAQs), and general advice on digital imaging and photography. Additional information may be available from the Nikon representative in your area. Visit the site below for contact information:

<http://imaging.nikon.com/>

Use Only Nikon Brand Electronic Accessories

Nikon COOLPIX cameras are designed to the highest standards and include complex electronic circuitry. Only Nikon brand electronic accessories (including battery chargers, batteries, and AC adapters) certified by Nikon specifically for use with this Nikon digital camera are engineered and proven to operate within the operational and safety requirements of this electronic circuitry.

THE USE OF NON-NIKON ELECTRONIC ACCESSORIES COULD DAMAGE THE CAMERA AND MAY VOID YOUR NIKON WARRANTY.

For more information about Nikon brand accessories, contact a local authorized Nikon dealer.

Before Taking Important Pictures

Before taking pictures on important occasions (such as at weddings or before taking the camera on a trip), take a test shot to ensure that the camera is functioning normally. Nikon will not be held liable for damages or lost profits that may result from product malfunction.

About the Manuals

- No part of the manuals included with this product may be reproduced, transmitted, transcribed, stored in a retrieval system, or translated into any language in any form, by any means, without Nikon's prior written permission.
- Nikon reserves the right to change the specifications of the hardware and software described in these manuals at any time and without prior notice.
- Nikon will not be held liable for any damages resulting from the use of this product.
- While every effort was made to ensure that the information in these manuals is accurate and complete, we would appreciate it were you to bring any errors or omissions to the attention of the Nikon representative in your area (address provided separately).

Notice Concerning Prohibition of Copying or Reproduction

Note that simply being in possession of material that was digitally copied or reproduced by means of a scanner, digital camera or other device may be punishable by law.

- **Items prohibited by law from being copied or reproduced**

Do not copy or reproduce paper money, coins, securities, government bonds or local government bonds, even if such copies or reproductions are stamped "Sample." The copying or reproduction of paper money, coins, or securities which are circulated in a foreign country is prohibited. Unless the prior permission of the government was obtained, the copying or reproduction of unused postage stamps or post cards issued by the government is prohibited.

The copying or reproduction of stamps issued by the government and of certified documents stipulated by law is prohibited.

- **Cautions on certain copies and reproductions**

The government has issued cautions on copies or reproductions of securities issued by private companies (shares, bills, checks, gift certificates, etc.), commuter passes, or coupon tickets, except when a minimum of necessary copies are to be provided for business use by a company. Also, do not copy or reproduce passports issued by the government, licenses issued by public agencies and private groups, ID cards and tickets, such as passes and meal coupons.

- **Comply with copyright notices**

The copying or reproduction of copyrighted creative works such as books, music, paintings, woodcut prints, maps, drawings, movies, and photographs is governed by national and international copyright laws. Do not use this product for the purpose of making illegal copies or to infringe copyright laws.

Disposing of Data Storage Devices

Please note that deleting images or formatting data storage devices such as memory cards or built-in camera memory does not completely erase the original image data. Deleted files can sometimes be recovered from discarded storage devices using commercially available software, potentially resulting in the malicious use of personal image data. Ensuring the privacy of such data is the user's responsibility.

Before discarding a data storage device or transferring ownership to another person, erase all data using commercial deletion software, or format the device and then completely refill it with images containing no private information (for example, pictures of empty sky). Be sure to also replace any pictures selected for the **Select an image** option in the **Welcome screen** setting (📖 82). Care should be taken to avoid injury or damage to property when physically destroying data storage devices.

For Your Safety

To prevent damage to your Nikon product or injury to yourself or to others, read the following safety precautions in their entirety before using this equipment. Keep these safety instructions where all those who use the product will read them.



This icon marks warnings, information that should be read before using this Nikon product, to prevent possible injury.

WARNINGS

Turn off in the event of malfunction

Should you notice smoke or an unusual smell coming from the camera or AC adapter, unplug the AC adapter and remove the batteries immediately, taking care to avoid burns. Continued operation could result in injury. After removing or disconnecting the power source, take the equipment to a Nikon-authorized service representative for inspection.

Do not disassemble

Touching the internal parts of the camera or AC adapter could result in injury. Repairs should be performed only by qualified technicians. Should the camera or AC adapter break open

as the result of a fall or other accident, take the product to a Nikon-authorized service representative for inspection, after unplugging the product and/or removing the batteries.

Do not use the camera or AC adapter in the presence of flammable gas

Do not use electronic equipment in the presence of flammable gas, as this could result in explosion or fire.

Handle the camera strap with care

Never place the strap around the neck of an infant or child.

 Keep out of reach of children

Particular care should be taken to prevent infants from putting the batteries or other small parts into their mouths.

 Do not remain in contact with the camera, battery charger, or AC adapter for extended periods while the devices are on or in use

Parts of the devices become hot. Leaving the devices in direct contact with the skin for extended periods may result in low-temperature burns.

 Observe caution when handling batteries

Batteries may leak or explode if improperly handled. Observe the following precautions when handling batteries for use in this product:

- Before replacing the batteries, turn the product off. If you are using an AC adapter, be sure it is unplugged.
- Use only the batteries approved for use in this product ( 10). Do not combine old and new batteries or batteries of different makes or types.
- If Nikon rechargeable Ni-MH batteries EN-MH2 (EN-MH2-B2 or EN-MH2-B4) are purchased separately, charge and use each of them as a set. Do not combine batteries from different pairs.
- The EN-MH2 rechargeable batteries are for use with Nikon digital cameras only, and are compatible with COOLPIX L28.
- Insert batteries in the correct orientation.
- Do not short or disassemble batteries or attempt to remove or break battery insulation or casing.
- Do not expose batteries to flame or to excessive heat.
- Do not immerse in or expose to water.
- Do not transport or store with metal objects such as necklaces or hairpins.
- Batteries are prone to leakage when fully discharged. To avoid damage to the product, be sure to remove the batteries when no charge remains.

- Discontinue use immediately should you notice any change in the batteries, such as discoloration or deformation.
- If liquid from damaged batteries comes in contact with clothing or skin, rinse immediately with plenty of water.

 **Observe the following precautions when handling the Battery Chargers (available separately)**

- Keep dry. Failure to observe this precaution could result in fire or electric shock.
- Dust on or near the metal parts of the plug should be removed with a dry cloth. Continued use could result in fire.
- Do not handle the power cable or go near the battery charger during lightning storms. Failure to observe this precaution could result in electric shock.
- Do not damage, modify, forcibly tug or bend the power cable, place it under heavy objects, or expose it to heat or flame. Should the insulation be damaged and the wires become exposed, take it to a Nikon-authorized service representative for inspection. Failure to observe these precautions could result in fire or electric shock.
- Do not handle the plug or battery charger with wet hands. Failure to observe this precaution could result in electric shock.
- Do not use with travel converters or adapters designed to convert from one voltage to another or with DC-to-AC inverters. Failure to observe this precaution could damage the product or result in overheating or fire.

⚠ Use appropriate cables

When connecting cables to the input and output jacks, use only the cables provided or sold by Nikon for the purpose, to maintain compliance with product regulations.

⚠ Handle moving parts with care

Be careful that your fingers or other objects are not pinched by the lens cover or other moving parts.

⚠ CD-ROMs

The CD-ROMs included with this device should not be played back on audio CD equipment. Playing CD-ROMs on an audio CD player could cause hearing loss or damage the equipment.

⚠ Observe caution when using the flash

Using the flash close to your subject's eyes could cause temporary visual impairment. Particular care should be observed if photographing infants, when the flash should be no less than 1 m (3 ft 4 in.) from the subject.

⚠ Do not operate the flash with the flash window touching a person or object

Failure to observe this precaution could result in burns or fire.

⚠ Avoid contact with liquid crystal

Should the monitor break, care should be taken to avoid injury caused by broken glass and to prevent liquid crystal from the monitor touching the skin or entering the eyes or mouth.

⚠ Turn the power off when using inside an airplane or the hospital

Turn the power off while inside the airplane during take off or landing. Follow the instructions of the hospital when using while in a hospital. The electromagnetic waves given out by this camera may disrupt the electronic systems of the airplane or the instruments of the hospital. Remove the Eye-Fi card, which can be the cause of the disruption, beforehand if inserted in the camera.

Notices

Notice for Customers in the U.S.A.

Federal Communications Commission (FCC) Radio Frequency Interference Statement

This equipment has been tested and found to comply with the limits for a Class B digital device, pursuant to Part 15 of the FCC rules. These limits are designed to provide reasonable protection against harmful interference in a residential installation. This equipment generates, uses, and can radiate radio frequency energy and, if not installed and used in accordance with the instructions, may cause harmful interference to radio communications. However, there is no guarantee that interference will not occur in a particular installation. If this equipment does cause harmful interference to radio or television reception, which can be determined by turning the equipment off and on, the user is encouraged to try to correct the interference by one or more of the following measures:

- Reorient or relocate the receiving antenna.

- Increase the separation between the equipment and receiver.
- Connect the equipment into an outlet on a circuit different from that to which the receiver is connected.
- Consult the dealer or an experienced radio/television technician for help.



Nikon

COOLPIX L28

CAUTIONS

Modifications

The FCC requires the user to be notified that any changes or modifications made to this device that are not expressly approved by Nikon Corporation may void the user's authority to operate the equipment.

Interface Cables

Use the interface cables sold or provided by Nikon for your equipment. Using other interface cables may exceed the limits of Class B Part 15 of the FCC rules.

Notice for customers in the State of California

WARNING

Handling the cord on this product will expose you to lead, a chemical known to the State of California to cause birth defects or other reproductive harm.

Wash hands after handling.

Nikon Inc.,
1300 Walt Whitman Road Melville,
New York 11747-3064 USA
Tel: 631-547-4200

Notice for customers in Canada

CAUTION

This Class B digital apparatus complies with Canadian ICES-003.

ATTENTION

Cet appareil numérique de la classe B est conforme à la norme NMB-003 du Canada.

Symbol for Separate Collection in European Countries

This symbol indicates that this product is to be collected separately.



The following apply only to users in European countries:

- This product is designated for separate collection at an appropriate collection point. Do not dispose of as household waste.
- For more information, contact the retailer or the local authorities in charge of waste management.

This symbol on the batteries indicates that the batteries are to be collected separately.















































The following apply only to users in European countries:

- All batteries, whether marked with this symbol or not, are designated for separate collection at an appropriate collection point. Do not dispose of as household waste.
- For more information, contact the retailer or the local authorities in charge of waste management.

Table of Contents

Introduction	ii	Step 3 Frame a Picture	22
Read This First	ii	Using the Zoom	23
Attaching the Camera Strap.....	iii	Step 4 Focus and Shoot	24
About This Manual	iv	The Shutter-release Button	25
Information and Precautions	vi	Step 5 Play Back Images	26
For Your Safety	x	Step 6 Delete Images.....	28
WARNINGS	x		
Notices	xiv	Shooting Features	31
		📷 (Easy Auto) Mode	32
Parts of the Camera	1	Scene Mode (Shooting Suited to Scenes) ...	33
The Camera Body	2	To View a Description of Each Scene.....	34
Using Menus (MENU Button)	4	Characteristics of Each Scene	34
The Monitor	6	Smart Portrait Mode	
Shooting Mode	6	(Capturing Smiling Faces)	39
Playback Mode	8	Using Skin Softening	41
		📷 (Auto) Mode	42
The Basics of Shooting and Playback....	9	Features That Can Be Set Using the Multi	
Preparation 1 Insert the Batteries	10	Selector.....	43
Applicable Batteries.....	10	Available Features	43
Preparation 2 Insert a Memory Card.....	12	Using the Flash (Flash Modes).....	44
Internal Memory and Memory Cards.....	13	Using the Self-timer	47
Preparation 3 Set the Display Language,		Using Macro Mode.....	49
Date, and Time.....	14	Adjusting Brightness	
Step 1 Turn the Camera On.....	18	(Exposure Compensation)	51
Turning the Camera On and Off	19	Default Settings	52
Step 2 Select a Shooting Mode.....	20	Features That Can Be Set by Pressing the	
Available Shooting Modes	21	MENU Button (Shooting Menu)	54
		Available Shooting Menus.....	55
		Features That Cannot Be Used	
		Simultaneously.....	56

Focusing.....	57	Editing Still Images.....	05
Using Face Detection.....	57	Editing Features.....	05
Focus Lock.....	59	D-Lighting:	
		Enhancing Brightness and Contrast.....	07
Playback Features.....	61	Skin Softening:	
Playback Zoom.....	62	Softening Skin Tones.....	08
Thumbnail Display, Calendar Display.....	63	Small Picture:	
Features That Can Be Set by Pressing the		Reducing the Size of an Image.....	09
MENU Button (Playback Menu).....	64	Crop: Creating a Cropped Copy.....	10
Connecting the Camera to a TV, Computer,		Connecting the Camera to a TV	
or Printer.....	65	(Viewing Images on a TV).....	12
Using ViewNX 2.....	67	Connecting the Camera to a Printer	
Installing ViewNX 2.....	67	(Direct Print).....	14
Transferring Images to the Computer.....	70	Connecting the Camera to a Printer...	15
Viewing Images.....	72	Printing Individual Images.....	17
		Printing Multiple Images.....	19
Recording and Playing Back Movies....	73	The Shooting Menu	
Recording Movies.....	74	(for  (Auto) Mode).....	22
Features That Can Be Set by Pressing the		Image Mode (Image Size and Quality)...	22
MENU Button (Movie Menu).....	77	White Balance (Adjusting Hue).....	24
Playing Back Movies.....	78	Continuous Shooting.....	27
		Color Options.....	28
General Camera Setup.....	81	The Smart Portrait Menu.....	29
Features That Can Be Set by Pressing the		Skin Softening.....	30
MENU Button (Setup Menu).....	82	Smile Timer.....	30
		Blink Proof.....	30
Reference Section.....	01		
Using Panorama Assist.....	02		

The Playback Menu		31	Technical Notes and Index		1
Print Order			Caring for the Product		2
(Create a DPOF Print Order).....		31	The Camera.....		2
Slide Show		34	Batteries.....		4
Protect.....		35	Memory Cards		6
Rotate Image.....		37	Cleaning and Storage		7
Copy (Copy Between Internal Memory and Memory Card)		38	Cleaning		7
The Movie Menu		40	Storage		7
Movie Options.....		40	Troubleshooting		8
Autofocus Mode.....		42	Specifications		15
The Setup Menu		43	Approved Memory Cards.....		19
Welcome Screen.....		43	Supported Standards.....		19
Time Zone and Date		44	Index		21
Monitor Settings		47			
Print Date (Imprinting Date and Time)...		49			
Electronic VR		50			
Motion Detection.....		52			
AF Assist		53			
Sound Settings		54			
Auto Off.....		55			
Format Memory/Format Card.....		56			
Language		57			
Video Mode		58			
Blink Warning.....		58			
Eye-Fi Upload.....		60			
Reset All.....		61			
Battery Type.....		64			
Firmware Version.....		64			
File and Folder Names		65			
Optional Accessories		66			
Error Messages		67			



Parts of the Camera

This chapter describes the parts of the camera and explains information that is displayed in the monitor.

The Camera Body	2
Using Menus (MENU Button)	4
The Monitor	6
Shooting Mode	6
Playback Mode	8

➔ If you want to start using the camera right away, see “The Basics of Shooting and Playback” (📖 9).

The Camera Body

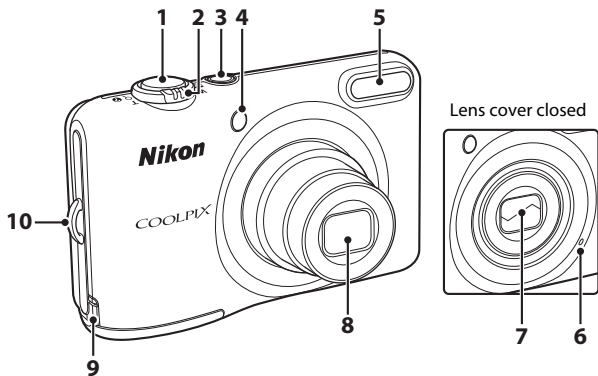

1 Shutter-release button..... 24

Zoom control..... 23

W : Wide-angle..... 23

T : Telephoto..... 23

: Thumbnail playback..... 63

: Playback zoom..... 62

: Help..... 34

3 Power switch/power-on lamp..... 18

4 Self-timer lamp..... 47

AF-assist illuminator..... 82

5 Flash..... 44

6 Microphone..... 74

7 Lens cover

8 Lens

9 Power connector cover (for connecting optional AC adapter)..... 66

10 Eyelet for camera strap..... iii

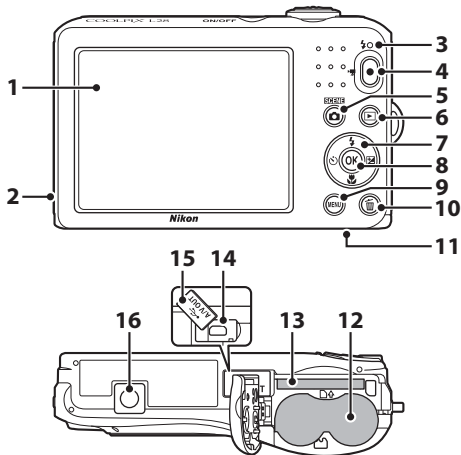

1	Monitor	6	9	MENU button	4, 54, 64, 77, 82
2	Speaker	79	10	(delete) button	28
3	Flash lamp.....	46	11	Battery-chamber/ memory card slot cover.....	10, 12
4	(movie-record) button.....	74	12	Battery chamber	10
5	(shooting mode) button...32, 33, 39, 42		13	Memory card slot.....	12
6	(playback) button.....	26	14	USB/audio/video output connector.....	65
7	Multi selector		15	Connector cover.....	65
8	(apply selection) button		16	Tripod socket.....	:17

Using Menus (MENU Button)

You can use the multi selector and the **OK** button to navigate the menus.

1 Press the **MENU** button.

- The menu is displayed.

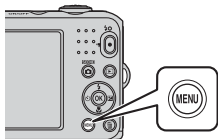

2 Press the multi selector **◀**.

- The selected menu icon is displayed in yellow.

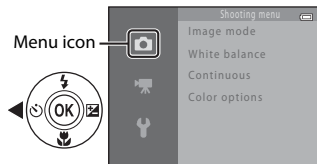

3 Press **▲** or **▼** to select the desired menu icon.

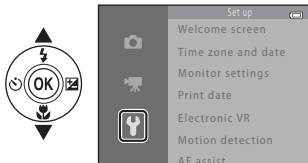

4 Press the **OK** button.

- You can now select items within the menu.

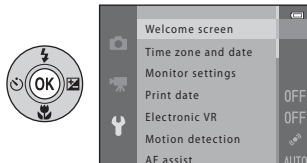

- 5** Press ▲ or ▼ to select an item in the menu.

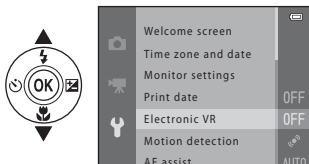

- 6** Press the **OK** button.
- The settings for the item you selected are displayed.

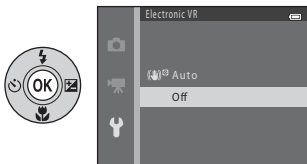

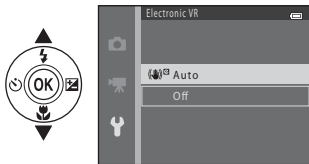

- 7** Press ▲ or ▼ to select a setting.



- 8** Press the **OK** button.
- The setting you selected is applied.
 - When you are finished using the menu, press the **MENU** button.



Notes About Setting Menu Items





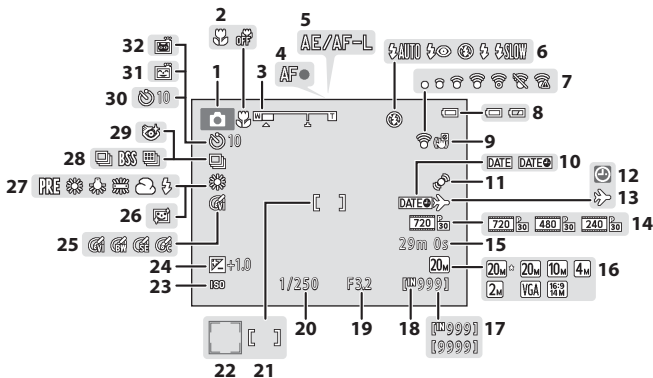

- Certain menu items cannot be set depending on the current shooting mode or the state of the camera. Unavailable items are displayed in gray and cannot be selected.
- When a menu is displayed, you can switch to shooting mode by pressing the shutter-release button, the  (shooting mode) button, or the  (movie-record) button.

The Monitor

- The information that is displayed in the monitor during shooting and playback changes depending on the camera's settings and state of use.
By default, information is displayed when you turn on the camera and also when you operate the camera, and disappears after a few seconds (**Monitor settings** (📖 82) > **Photo info > Auto info**).

Shooting Mode



1	Shooting mode.....	32, 33, 39, 42
2	Macro mode.....	49
3	Zoom indicator.....	23, 49
4	Focus indicator.....	24
5	AE/AF-L indicator.....	 4
6	Flash mode.....	44
7	Eye-Fi indicator.....	83
8	Battery level indicator.....	18
9	Electronic VR icon.....	82
10	Print date.....	82
11	Motion detection icon.....	82
12	“Date not set” indicator.....	17, 82,  67
13	Travel destination icon.....	82
14	Movie options.....	77
15	Movie recording time.....	74,  41
16	Image mode.....	55,  22
17	Number of exposures remaining (still images).....	18,  23
18	Internal memory indicator.....	18
19	Aperture value.....	25
20	Shutter speed.....	25
21	Focus area.....	24
22	Focus area (face detection, pet detection).....	24
23	ISO sensitivity.....	 12
24	Exposure compensation value.....	51
25	Color options.....	55
26	Skin softening.....	55
27	White balance.....	55
28	Continuous shooting mode.....	38, 55
29	Blink proof icon.....	55
30	Self-timer indicator.....	47
31	Smile timer.....	55
32	Pet portrait auto release.....	38

Playback Mode

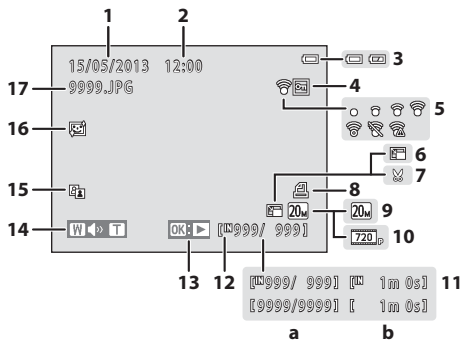

1	Date of recording	14
2	Time of recording	14
3	Battery level indicator	18
4	Protect icon	64
5	Eye-Fi indicator	83
6	Small picture icon	64
7	Cropped image icon	62
8	Print order icon	64
9	Image mode	55,

10	Movie options	77
11	(a) Current image number/ total number of images	26
	(b) Movie recording time	78
12	Internal memory indicator	26
13	Movie playback indicator	78
14	Volume indicator	79
15	D-Lighting icon	64
16	Skin softening icon	64
17	File number and type	65



The Basics of Shooting and Playback

Preparation

Preparation 1 Insert the Batteries	10
Preparation 2 Insert a Memory Card	12
Preparation 3 Set the Display Language, Date, and Time.....	14



Shooting

Step 1 Turn the Camera On	18
Step 2 Select a Shooting Mode.....	20
Step 3 Frame a Picture	22
Step 4 Focus and Shoot	24



Playback

Step 5 Play Back Images	26
Step 6 Delete Images.....	28

Preparation 1 Insert the Batteries

1 Open the battery-chamber/memory card slot cover.

- Before opening the battery-chamber/memory card slot cover, hold the camera upside down to prevent the batteries from falling out.

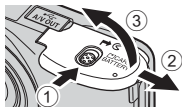

2 Insert the batteries.

- Confirm that the positive (+) and negative (-) terminals are oriented correctly as described on the label at the entrance of the battery chamber, and insert the batteries.

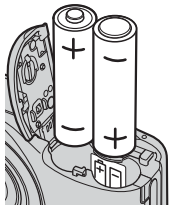

3 Close the battery-chamber/memory card slot cover.



Applicable Batteries

- Two LR6/L40 (AA-size) alkaline batteries (included batteries)
- Two FR6/L91 (AA-size) lithium batteries
- Two EN-MH2 rechargeable Ni-MH (nickel metal hydride) batteries

✓ Removing the Batteries

- Turn the camera off and be sure that the power-on lamp and the monitor have turned off before opening the battery-chamber/memory card slot cover.
- The camera, batteries, or memory card may be hot immediately after using the camera. Observe caution when removing the batteries or memory card.

✓ Notes About the Batteries

- Be sure to read and follow the warnings for the battery on page xi and in "Batteries" (🔧:4) before use.
- Do not combine old and new batteries or batteries of different makes or types.
- Batteries with the following defects cannot be used:

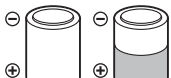

Batteries with peeling



Batteries with insulation that does not cover the area around the negative terminal

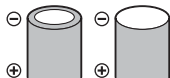

Batteries with a flat negative terminal

✓ Battery Type

By setting **Battery type** in the setup menu (📖 82) to match the type of batteries inserted in the camera, the batteries can perform more efficiently.

The default setting is the type of batteries included with purchase. When any other type of batteries are used, turn the camera on and change the setting.

🔪 Alkaline Batteries

Performance of alkaline batteries may vary greatly depending on the manufacturer. Choose a reliable brand.

🔪 AC Power Source

- You can use the AC Adapter EH-65A (available separately; 🛒:66) to power the camera from an electrical outlet.
- Do not, under any circumstances, use another make or model of AC adapter other than the EH-65A. Failure to observe this precaution could result in overheating or in damage to the camera.

Preparation 2 Insert a Memory Card

1 Turn off the camera and open the battery-chamber/memory card slot cover.

- When the camera turns off, the monitor turns off.
- Before opening the battery-chamber/memory card slot cover, hold the camera upside down to prevent the batteries from falling out.

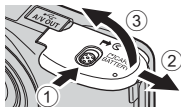

2 Insert a memory card.

- Slide the memory card in until it clicks into place.

Inserting a Memory Card

Inserting a memory card upside down or backwards could damage the camera and the memory card. Be sure to check that the memory card is in the correct orientation.

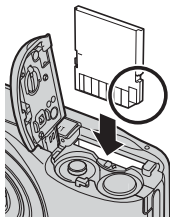

3 Close the battery-chamber/memory card slot cover.



✔ Formatting a Memory Card

- The first time you insert a memory card that has been used in another device into this camera, be sure to format it with this camera.
- **All data stored on a memory card is permanently deleted when the card is formatted.** Copy any data on the card that you wish to keep to a computer before formatting.
- To format a memory card, insert the card into the camera, press the **MENU** button, and select **Format card** (🔑 56) in the setup menu (📖 82).

✔ Notes About Memory Cards

See “Memory Cards” (🔑 6) and the documentation included with your memory card for more information.

Removing the Memory Card

Turn the camera off and be sure that the power-on lamp and the monitor have turned off before opening the battery-chamber/memory card slot cover.

Gently push the memory card into the camera (①) to partially eject the card, and then remove the card (②). Do not pull it at an angle.

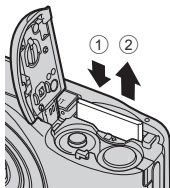

✔ High Temperature Caution

The camera, batteries, and memory card may be hot immediately after using the camera. Observe caution when removing the batteries or memory card.

Internal Memory and Memory Cards

Camera data, including images and movies, can be saved either in the camera’s internal memory (approx. 25 MB) or on a memory card. To use the camera’s internal memory for shooting or playback, first remove the memory card.

Preparation 3 Set the Display Language, Date, and Time

When the camera is turned on for the first time, the language-selection screen and the date and time setting screen for the camera clock are displayed.

1 Press the power switch to turn on the camera.

- When the camera is turned on, the power-on lamp (green) lights and then the monitor turns on (the power-on lamp turns off when the monitor turns on).

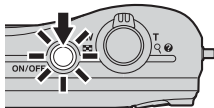

2 Press the multi selector ▲ or ▼ to select the desired language and then press the OK button.

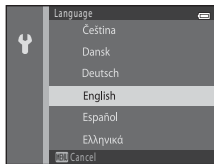

3 Press ▲ or ▼ to select Yes and then press the OK button.

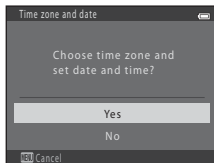

4 Press ◀ or ▶ to select your home time zone and then press the **OK** button.

- Press ▲ to enable daylight saving time. When the daylight saving time function is enabled, ☀ is displayed in the monitor. Press ▼ to disable daylight saving time.

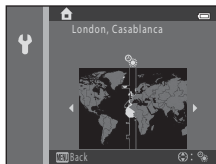

5 Press ▲ or ▼ to select the date format and then press the **OK** button.

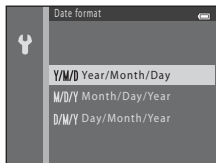

6 Press ▲, ▼, ◀, or ▶ to set the date and time, and then press the **OK** button.

- Select an item: Press ▶ or ◀ (changes between **D**, **M**, **Y**, hour, and minute).
- Edit the date and time: Press ▲ or ▼.
- Confirm the setting: Select the minute setting and then press the **OK** button.

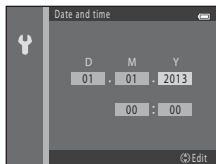

7 Press ▲ or ▼ to select **Yes** and then press the **OK** button.

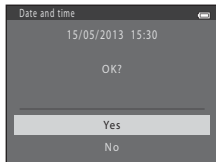

8 Press the button.

- The lens extends and the shooting-mode selection screen is displayed.

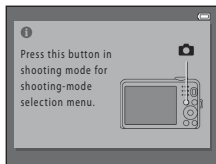

9 When **Easy auto mode** is displayed, press the button.

- The camera enters the shooting mode and you can take pictures in Easy auto mode (📖 20).
- To switch to another shooting mode, press ▲ or ▼ before pressing the  button.

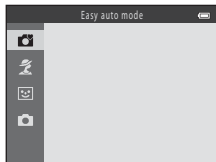

Changing the Language Setting and the Date and Time Setting

- You can change these settings using the **Language** (🔍57) and **Time zone and date** (🔍44) settings in the **Y** setup menu (📖 82).
- You can enable and disable daylight saving time by selecting the **Y** setup menu > **Time zone and date** (🔍44) > **Time zone**. When enabled, the clock moves forward one hour; when disabled, the clock moves back one hour. When the travel destination (👉) is selected, the time difference between the travel destination and the home time zone (🏠) is automatically calculated and the date and time in the selected region are saved at the time of shooting.
- If you exit without setting the date and time, ⌚ flashes when the shooting screen is displayed. Use the **Time zone and date** setting in the setup menu to set the date and time (📖 82, 🔍44).

The Clock Battery

- The camera's clock is powered by an internal backup battery. The backup battery is charged when the main batteries are inserted into the camera or when the camera is connected to an optional AC adapter, and can provide several days of backup power after about 10 hours of charging.
- If the camera's backup battery becomes exhausted, the date and time setting screen is displayed when the camera is turned on. Set the date and time again. → Step 3 of "Preparation 3 Set the Display Language, Date, and Time" (📖 14)

Imprinting the Shooting Date in Printed Images

- Set the date and time before shooting.
- You can permanently imprint the shooting date in images as they are captured by setting **Print date** (🔍49) in the setup menu (📖 82).
- If you want the shooting date to be printed without using the **Print date** setting, print using the ViewNX 2 software (📖 67).

Step 1 Turn the Camera On

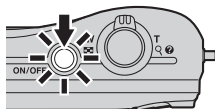

1 Press the power switch to turn on the camera.

- The lens extends and the monitor turns on.



2 Check the battery level indicator and the number of exposures remaining.

Battery Level Indicator

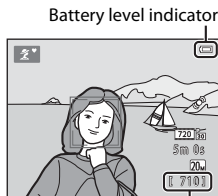

Display	Description
	Battery level high.
	Battery level low. Prepare to replace the batteries.
Battery exhausted.	Cannot take pictures. Replace the batteries.



Number of exposures remaining

Number of Exposures Remaining

The number of pictures that can be taken is displayed.

-  is displayed when no memory card is inserted in the camera, and images are saved in the internal memory (approx. 25 MB).
- The number of exposures remaining depends on the amount of available memory in the internal memory or memory card, and also varies depending on the image quality and image size (determined by the image mode setting;  55,  23).

Turning the Camera On and Off

- When the camera is turned on, the power-on lamp (green) lights and then the monitor turns on (the power-on lamp turns off when the monitor turns on).
- To turn off the camera, press the power switch. When the camera turns off, the power-on lamp and the monitor turn off.
- You can press and hold the  (playback) button to turn on the camera and switch to playback mode. The lens does not extend.

Power Saving Function (Auto Off)

If no operations are performed for a while, the monitor turns off, the camera enters standby mode, and the power-on lamp flashes. If no operations are performed for approx. another three minutes, the camera turns off automatically.

While the camera is in standby mode, the monitor turns back on if you perform any of the following operations:

→ Press the power switch, shutter-release button,  (shooting mode) button,  (playback) button, or  (movie-record) button

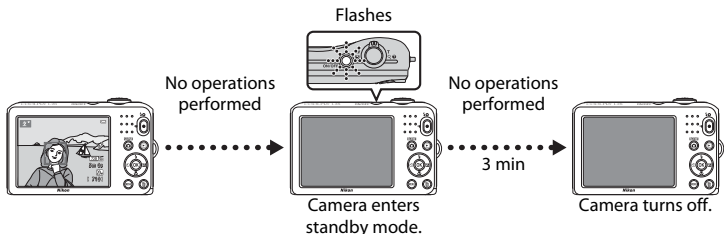

- The time that elapses before the camera enters standby mode can be changed using the **Auto off** setting in the setup menu ( 82).
- By default, the camera enters standby mode in about 30 seconds when you are using shooting mode or playback mode.

Step 2 Select a Shooting Mode

1 Press the button.

- The shooting-mode selection menu, which allows you to select the desired shooting mode, is displayed.

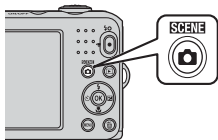





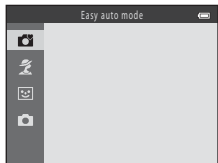





2 Press the multi selector or to select the desired shooting mode and then press the button.

-  (easy auto) mode is used in this example.
- The shooting mode setting is saved when the camera is turned off.



Available Shooting Modes

 Easy auto mode (📖 32)	The camera automatically selects the optimum scene mode when you frame a picture.
 Scene (📖 33)	Camera settings are optimized according to the scene that you select. <ul style="list-style-type: none">• To select a scene, first display the shooting-mode selection menu and then press the multi selector . Select the desired scene by pressing , , , or , and then press the  button.
 Smart portrait (📖 39)	When the camera detects a smiling face, you can take a picture automatically without pressing the shutter-release button (smile timer). You can also use the skin softening option to smooth the skin tones in people's faces.
 Auto mode (📖 42)	Used for general shooting. Settings can be adjusted in the shooting menu (📖 54) to suit the shooting conditions and the type of picture you want to take.

Changing Settings When Shooting

- Features That Can Be Set Using the Multi Selector → 📖 43
 - Using the flash → 📖 44
 - Using the self-timer → 📖 47
 - Using macro mode → 📖 49
 - Adjusting brightness (exposure compensation) → 📖 51
- Features That Can Be Set by Pressing the **MENU** Button (Shooting Menu) → 📖 54
- Features That Can Be Set by Pressing the **MENU** Button (Setup Menu) → 📖 82

Step 3 Frame a Picture

1 Hold the camera steady.

- Keep fingers, hair, the camera strap, and other objects away from the lens, flash, AF-assist illuminator, and microphone.
- When taking pictures in the “tall” (portrait) orientation, make sure the flash is above the lens.

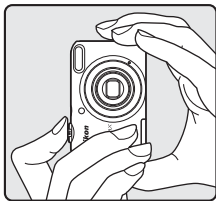
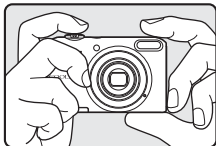

2 Frame the picture.

- Aim the camera at the desired subject.
- When the camera automatically determines the scene mode, the shooting mode icon changes (📖 32).

Shooting mode icon

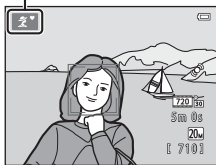

✓ Notes About Easy Auto Mode

- Depending upon shooting conditions, the camera may not select the desired scene mode. In this case, select another shooting mode (📖 33, 39, 42).
- When digital zoom is in effect, the shooting mode is 📷.

📌 When Using a Tripod

We recommend using a tripod to stabilize the camera in the following situations.

- When shooting in dimly lit conditions with the flash mode (📖 45) set to 📷 (off)
- When zooming in on the subject

Using the Zoom

Rotate the zoom control to activate optical zoom.

- To zoom in closer to the subject, rotate the zoom control to **T** (telephoto).
- To zoom out and view a larger area, rotate the zoom control to **W** (wide-angle).

When you turn the camera on, the zoom moves to the maximum wide-angle position.

- A zoom indicator is displayed at the top of the monitor when the zoom control is rotated.
- If you rotate the zoom control to **T** when the camera is zoomed in to the maximum optical zoom position, you can use the digital zoom to magnify the image further by up to 4x.

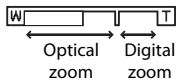
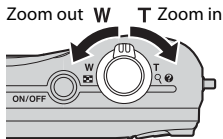

📌 Digital Zoom and Interpolation

When using the digital zoom, image quality deteriorates when zooming in past 📷 in the zoom indicator.

The position of 📷 is more to the right when shooting smaller images; therefore, when the image size is smaller (as determined by the image mode setting; 📖 55, 📷22), more digital zoom can be applied without image quality deterioration.

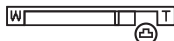

Small image size

Step 4 Focus and Shoot

1 Press the shutter-release button halfway (📖 25).

- When a face is detected:
The camera focuses on the face framed by the yellow double border (focus area). When the subject is in focus, the double border turns green.
- When no faces are detected:
The camera focuses on the subject in the center of the frame. When the camera has focused, the focus area turns green.
- When you are using digital zoom, the camera focuses on the subject in the center of the frame and the focus area is not displayed. When the camera has focused, the focus indicator (📖 6) lights in green.
- While the shutter-release button is pressed halfway, the focus area or focus indicator may flash in red. This indicates that the camera is unable to focus. Modify the composition and then press the shutter-release button halfway again.

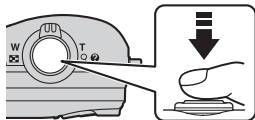



2 Press the shutter-release button the rest of the way down (📖 25).

- The shutter is released and the image is saved.



The Shutter-release Button

<p>Press halfway</p> 	<p>To set focus and exposure (shutter speed and aperture value), press the shutter-release button halfway, stopping when you feel resistance. Focus and exposure remain locked while the shutter-release button is pressed halfway.</p>
<p>Press all the way</p> 	<p>While pressing the shutter-release button halfway, press the shutter-release button the rest of the way down to release the shutter and take a picture. Do not use force when pressing the shutter-release button, as this may result in camera shake and blurred images. Press the button gently.</p>



✓ Notes About Saving Data

After taking pictures or recording movies, the number of exposures remaining or the remaining recording time flashes while images or movies are being saved. **Do not open the battery-chamber/memory card slot cover.** Image and movie data could be lost and the camera or memory card could be damaged.

✓ Notes About Focus

Subjects Not Suitable for Autofocus →  60

AF-assist Illuminator and Flash

If the subject is dimly lit, the AF-assist illuminator ( 82) may light when the shutter-release button is pressed halfway, and the flash ( 44) may fire when the shutter-release button is pressed all the way down.

To Make Sure You Do Not Miss a Shot

If you are concerned that you might miss a shot, press the shutter-release button all the way without first pressing it halfway.







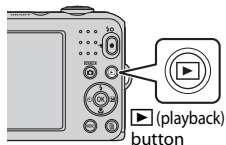





Step 5 Play Back Images

1 Press the (playback) button.

- The camera switches to playback mode and the last image saved is displayed full-frame.



2 Use the multi selector to select an image to display.

- Display the previous image:  or 
- Display the next image:  or 
- Press and hold , , , or  to scroll quickly through images.
- Remove the memory card from the camera to play back images saved in the camera's internal memory.  is displayed near the current image number/total number of images.
- To return to shooting mode, press the  button, the shutter-release button, or the  ( movie-record) button.

Displays the previous image



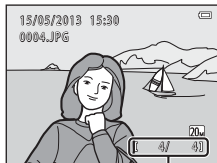

Displays the next image



Current image number/
total number of images

Viewing Images

- Images may be displayed briefly at low resolution immediately after switching to the previous image or next image.
- When you play back images in which the face of a person ( 57) or pet ( 38) was detected at the time of shooting, depending on the orientation of the detected face, the images are automatically rotated for playback display.



More Information

- Playback Zoom →  62
- Thumbnail Display, Calendar Display →  63
- Features That Can Be Set by Pressing the **MENU** Button (Playback Menu) →  64

Step 6 Delete Images

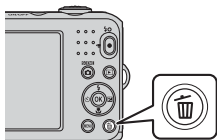
- 1 Press the  button to delete the image currently displayed in the monitor.



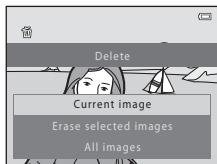

- 2 Press the multi selector  or  to select the desired deletion method and then press the  button.

- **Current image:** Only the current image is deleted.
- **Erase selected images:** Multiple images can be selected and deleted ( 29).
- **All images:** All images are deleted.
- To exit without deleting, press the **MENU** button.



- 3 Press  or  to select **Yes** and then press the  button.

- Deleted images cannot be recovered.
- To cancel, press  or  to select **No** and then press the  button.





Operating the Erase Selected Images Screen

1 Press the multi selector ◀ or ▶ to select an image to be deleted, and then press ▲ to add .

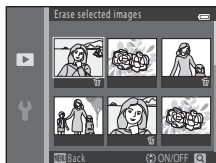
- To undo the selection, press ▼ to remove .
- Rotate the zoom control ( 2) to T (R) to switch to full-frame playback mode or W () to display thumbnails.



2 Add  to all images that you want to delete and then press the  button to confirm the selection.

- A confirmation dialog is displayed. Follow the instructions displayed in the monitor.

Notes About Deletion

- Deleted images cannot be recovered. Copy important images to a computer before deleting them from the camera.
- Protected images ( 64) cannot be deleted.

Deleting the Last Image Captured While in Shooting Mode

When using shooting mode, press the  button to delete the last image that was saved.





A series of ten horizontal dashed lines spanning the width of the page, intended for handwriting practice.



Shooting Features



This chapter describes the camera's shooting modes and the features that are available when using each shooting mode.

You can adjust settings according to the shooting conditions and the kind of pictures you want to take.

 (Easy Auto) Mode	32
Scene Mode (Shooting Suited to Scenes)	33
Smart Portrait Mode (Capturing Smiling Faces) ...	39
 (Auto) Mode	42
Features That Can Be Set Using the Multi Selector	43
Using the Flash (Flash Modes)	44
Using the Self-timer	47
Using Macro Mode.....	49
Adjusting Brightness (Exposure Compensation).....	51
Features That Can Be Set by Pressing the MENU Button (Shooting Menu) ...	54
Features That Cannot Be Used Simultaneously.....	56
Focusing	57

(Easy Auto) Mode

The camera automatically selects the optimum scene mode when you frame a picture.

Enter shooting mode →  (shooting mode) button →  (easy auto) mode →  button

Automatic Scene Selection

The camera automatically selects one of the following scenes when you point the camera at a subject:







-  Portrait
-  Landscape
-  Night portrait
-  Night landscape
-  Close-up
-  Backlighting
-  Other scenes

Changing (Easy Auto) Mode Settings



















- Depending on the scene selected by the camera, you can press the multi selector  (▲),  (◀), or  (▶) to set the corresponding features. → “Features That Can Be Set Using the Multi Selector” (📖 43), “Default Settings” (📖 52)
- Features that can be set by pressing the **MENU** button → Image mode (image size and quality; 📖 55,  22)

Scene Mode (Shooting Suited to Scenes)

When one of the following scenes is selected, camera settings are automatically optimized for the selected scene.

Enter shooting mode →  (shooting mode) button →  (second icon from the top*) →     → select a scene →  button

* The icon of the last scene selected is displayed.

 Portrait (default setting; 📖 34)	 Landscape (📖 34)	 Sports (📖 34)	 Night portrait (📖 35)
 Party/indoor (📖 35)	 Beach (📖 35)	 Snow (📖 35)	 Sunset (📖 35)
 Dusk/dawn (📖 35)	 Night landscape (📖 35)	 Close-up (📖 36)	 Food (📖 36)
 Museum (📖 36)	 Fireworks show (📖 37)	 Black and white copy (📖 37)	 Backlighting (📖 37)
 Panorama assist (📖 37)	 Pet portrait (📖 38)		

Changing Scene Mode Settings

- Depending on the scene, the multi selector , , , or  can be used to set the corresponding features. → “Features That Can Be Set Using the Multi Selector” (📖 43), “Default Settings” (📖 52)
- Features that can be set by pressing the **MENU** button → Image mode (image size and quality; 📖 55, 📖 22)

To View a Description of Each Scene

Select the desired scene from the scene selection screen and rotate the zoom control (📖 2) to **T** (🔍) to view a description of that scene. To return to the original screen, rotate the zoom control to **T** (🔍) again.

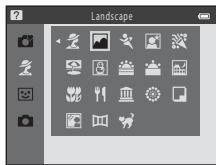

Characteristics of Each Scene

👤 Portrait

- When the camera detects a person's face, it focuses on that face (📖 57).
- The skin softening feature makes the skin tones in people's faces appear smoother (📖 41).
- If no faces are detected, the camera focuses on the subject in the center of the frame.
- Digital zoom cannot be used.
- The camera focuses even when the shutter-release button is not pressed halfway. You may hear the sound of the camera focusing.

🖼️ Landscape

- The focus area or focus indicator (📖 7) always turns green when the shutter-release button is pressed halfway.

🏃 Sports

- The camera focuses on the area in the center of the frame.
- If you continue to hold the shutter-release button all the way down, about six images are captured continuously at a rate of about 1.1 fps (when **Image mode** is set to **20M 5152x3864**).
- The camera focuses even when the shutter-release button is not pressed halfway. You may hear the sound of the camera focusing.
- Focus, exposure, and hue are fixed at the values determined with the first image in each series.
- The frame rate with continuous shooting may vary depending upon the current image mode setting, the memory card used, or shooting condition.

 Night portrait

- The flash always fires.
- When the camera detects a person's face, it focuses on that face (📖 57).
- The skin softening feature makes the skin tones in people's faces appear smoother (📖 41).
- If no faces are detected, the camera focuses on the subject in the center of the frame.
- Digital zoom cannot be used.

 Party/indoor

- The camera focuses on the area in the center of the frame.
- As images are easily affected by camera shake, hold the camera steadily. In a dark place, the use of a tripod is recommended.

 Beach

- The camera focuses on the area in the center of the frame.

 Snow

- The camera focuses on the area in the center of the frame.

 Sunset



- The camera focuses on the area in the center of the frame.

 Dusk/dawn



- The focus area or focus indicator (📖 7) always turns green when the shutter-release button is pressed halfway.

 Night landscape





- The focus area or focus indicator (📖 7) always turns green when the shutter-release button is pressed halfway.

 Shutter speed is reduced when using scene modes indicated with ; therefore, the use of a tripod is recommended.

Close-up

- Macro mode ( 49) is enabled and the camera automatically zooms to the closest position at which it can shoot.
- The camera focuses on the area in the center of the frame. Use focus lock to frame the picture on an object not in the center of the frame ( 59).
- The camera focuses even when the shutter-release button is not pressed halfway. You may hear the sound of the camera focusing.

Food

- Macro mode ( 49) is enabled and the camera automatically zooms to the closest position at which it can shoot.
- You can adjust hue by pressing the multi selector  or . The hue setting is saved in the camera's memory even after the camera is turned off.
- The camera focuses on the area in the center of the frame. Use focus lock to frame the picture on an object not in the center of the frame ( 59).
- The camera focuses even when the shutter-release button is not pressed halfway. You may hear the sound of the camera focusing.

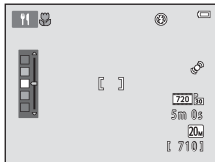

Museum

- The flash does not fire.
- The camera focuses on the area in the center of the frame.
- The camera captures a series of up to 10 images while the shutter-release button is held all the way down, and the sharpest image in the series is automatically selected and saved (BSS (best shot selector)).

Fireworks show



- Shutter speed is fixed at four seconds.
- The camera focuses at infinity.
- When the shutter-release button is pressed halfway, the focus indicator ( 7) always turns green.









Black and white copy



- The camera focuses on the area in the center of the frame.
- Use together with macro mode ( 49) when shooting subjects that are close to the camera.

Backlighting



- The flash always fires.
- The camera focuses on the area in the center of the frame.

Panorama assist



- Use this setting to capture a series of images that will be connected using a computer to form a panorama image ( 2).
- Press the multi selector , ,  or  to select the direction that you will move the camera in when capturing images, and press the  button.
- After shooting the first image, confirm on the screen how the captured image will be connected to the next image, and shoot the next image. Shoot as many images as needed to complete the panorama. To finish shooting, press the  button.
- Transfer the images to your computer and use the Panorama Maker ( 69,  4) software to combine the images into a single panorama image.

 Shutter speed is reduced when using scene modes indicated with ; therefore, the use of a tripod is recommended.

Pet portrait

- When you aim the camera at the face of a dog or cat, the camera can detect the face and focus on it. By default, the camera automatically releases the shutter once it has focused (pet portrait auto release).
- After you select  **Pet portrait**, select **Single** or **Continuous** on the next screen.
 - **Single:** Images are captured one at a time.
 - **Continuous:** When the camera has focused on the detected face, it captures three images continuously at a rate of about 1.1 fps. When shooting manually, the camera captures up to about six images at a rate of about 1.1 fps while you hold the shutter-release button all the way down (when **Image mode** is set to  **5152x3864**).

Pet Portrait Auto Release

- To change **Pet portrait auto release** settings, press the multi selector  (Ⓢ).
 - : When the camera detects a pet's face, it focuses and then releases the shutter automatically.
 - **OFF:** The camera does not release the shutter automatically, even if a pet's face is detected. Press the shutter-release button to release the shutter. The camera also detects people's faces (👤 57). If the camera detects a person's face and a pet's face in the same shot, it focuses on the pet's face.
 - **Pet portrait auto release** turns off automatically when:
 - Five bursts have been taken.
 - Internal memory or the memory card is full.
- To continue shooting with **Pet portrait auto release**, press the multi selector  (Ⓢ) to set again.

Focus Area

- When the camera detects a face, a yellow double border (focus area) is displayed around the face, and the double border turns green when the camera has focused.
- When the camera detects more than one dog or cat face (up to five can be detected), the face displayed largest in the monitor is framed by a double border and the others by single borders.
- If no pets' or people's faces are detected, the camera focuses on the subject in the center of the frame.

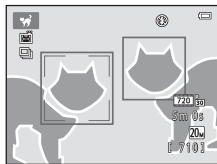



Notes About Pet Portrait

- Digital zoom cannot be used.
- Depending on the distance of the subject from the camera, the speed of the subject's movement, the direction that the subject is facing, the ambient brightness of the face, etc., pet faces may not be detected or other subjects may be framed by a border.

Smart Portrait Mode (Capturing Smiling Faces)

When the camera detects a smiling face, you can take a picture automatically without pressing the shutter-release button (smile timer). You can use the skin softening option to smooth the skin tones in people's faces.

Enter shooting mode →  (shooting mode) button →  Smart portrait mode →  button

1 Frame the picture.

- Point the camera at a person's face.
- "Using Face Detection" (📖 57)

2 Wait for the subject to smile. Do not press the shutter-release button.

- If the camera detects that the face framed by the double border is smiling, it automatically releases the shutter (**Smile timer**; 📖 55, 🔄30).
- After the camera releases the shutter, it continues to detect faces and smiles, and releases the shutter again if it detects a smiling face.

3 Shooting ends.

- To cancel smile detection and stop shooting, perform any of the following operations:
 - Turn the camera off.
 - Set **Smile timer** (📖 55, 🔄30) to **Off**.
 - Press the  button and select a different shooting mode.

✔ Notes About Smart Portrait Mode

- Digital zoom cannot be used.
- Under some shooting conditions, the camera may be unable to detect faces or detect smiles.
- “Notes About Face Detection” →  58

Auto Off When Using Smile Timer

When **Smile timer** is set to **On**, the auto off function ( 82) is activated and the camera turns off when either of the situations indicated below persists and no other operations are performed.

- The camera does not detect any faces.
- The camera detected a face, but cannot detect a smile.





When the Self-timer Lamp Flashes

When using smile timer, the self-timer lamp flashes when the camera detects a face and flashes quickly immediately after the shutter is released.

Releasing the Shutter Manually

The shutter can also be released by pressing the shutter-release button. If no faces are detected, the camera focuses on the subject in the center of the frame.

Changing Smart Portrait Mode Settings





- Features that can be set using the multi selector ( 43) → Flash mode ( 44), self-timer ( 47), and exposure compensation ( 51)
- Features that can be set by pressing the **MENU** button → Features That Can Be Set by Pressing the **MENU** Button (Shooting Menu) ( 54)

✔ Features That Cannot Be Used Simultaneously

Some settings cannot be used with other functions ( 56).

Using Skin Softening

When the shutter is released in one of the following shooting modes, the camera detects one or more person's faces (up to three), and processes the image to soften facial skin tones.

- **Portrait** and **Night portrait** in  (easy auto) mode ( 32)
- **Portrait** ( 34) or **Night portrait** ( 35) in scene mode
- Smart portrait mode ( 39)



Skin softening can also be applied to saved images ( 64,  8).

Notes About Skin Softening

- It may take more time than usual to save images after shooting.
- Under some shooting conditions, the desired skin softening results may not be achieved, or skin softening may be applied to areas of the image where there are no faces.







(Auto) Mode

Used for general shooting. Settings can be adjusted in the shooting menu ( 54) to suit the shooting conditions and the type of picture you want to take.

Enter shooting mode →  (shooting mode) button →  (auto) mode →  button

- The camera focuses on the area in the center of the frame.

Changing (Auto) Mode Settings

- Features that can be set using the multi selector ( 43) → Flash mode ( 44), self-timer ( 47), macro mode ( 49), and exposure compensation ( 51)
- Features that can be set by pressing the **MENU** button → Features That Can Be Set by Pressing the **MENU** Button (Shooting Menu) ( 54)

Features That Cannot Be Used Simultaneously

Some settings cannot be used with other functions ( 56).

Features That Can Be Set Using the Multi Selector

When shooting, the multi selector ▲, ▼, ◀, or ▶ can be used to set the following features.

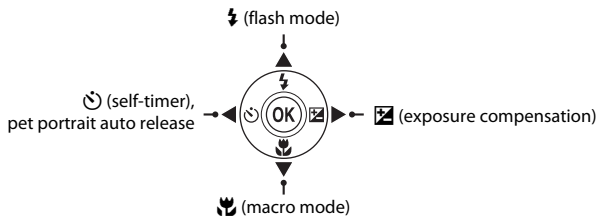

Available Features

The features that are available vary with the shooting mode, as shown below.

- See “Default Settings” (📖 52) for information about each mode’s default settings.

	📷 (easy auto)	Scene	Smart portrait	📷 (auto)
⚡ Flash mode (📖 44)	✓ ¹	2	✓ ³	✓
🕒 Self-timer (📖 47)	✓		✓ ³	✓
Pet portrait auto release (📖 38)	–		–	–
🌸 Macro (📖 49)	–		–	✓
📷 Exposure compensation (📖 51)	✓		✓	✓

¹ Varies by the scene selected by the camera. → “Default Settings” (📖 52)

² Varies by the scene. → “Default Settings” (📖 52)

³ Varies by the smart portrait menu setting. → “Default Settings” (📖 52)

Using the Flash (Flash Modes)

You can set the flash mode.

- 1 Press the multi selector ▲ (⚡ flash mode).



- 2 Press ▲ or ▼ to select the desired mode and then press the OK button.

- Available Flash Modes → 45
- If a setting is not applied by pressing the OK button within a few seconds, the selection is canceled.
- When ⚡ AUTO (auto) is applied, AUTO is only displayed for a few seconds, regardless of **Monitor settings** (82, 47).

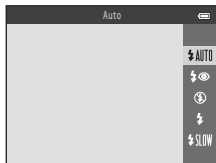

Available Flash Modes

AUTO Auto

The flash fires automatically when lighting is dim.

Auto with red-eye reduction

Reduces red-eye in portraits caused by the flash ( 46).

Off

The flash does not fire.

- We recommend using a tripod to stabilize the camera when shooting in dark surroundings.

Fill flash

The flash fires whenever a picture is taken. Use to “fill-in” (illuminate) shadows and backlit subjects.

SLOW Slow sync

Auto flash mode is combined with slow shutter speed.

Suited to evening and night portraits that include background scenery. The flash illuminates main subject; slow shutter speeds are used to capture background at night or under dim lighting.

The Flash Lamp

The flash lamp indicates the status of the flash when you press the shutter-release button halfway.

- On: The flash fires when a picture is taken.
- Flashing: The flash is charging. The camera cannot take pictures.
- Off: The flash does not fire when a picture is taken.

If the battery level is low, the monitor turns off while the flash is charging.

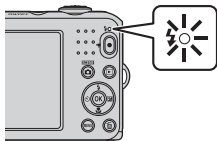

The Flash Mode Setting

- The setting varies with the shooting mode.
 - “Available Features” (📖 43)
 - “Default Settings” (📖 52)
- Some settings cannot be used with other functions (📖 56).
- The flash mode setting applied in  (auto) mode is saved in the camera’s memory even after the camera is turned off.

Effective Range of the Flash

The flash has a range of approx. 0.5–4.3 m (1 ft 8 in.–14 ft) at the maximum wide-angle zoom position and a range of approx. 0.8–2.1 m (2 ft 8 in.–6 ft 10 in.) at the maximum telephoto zoom position.

Red-eye Reduction

This camera uses “Advanced Red-Eye Reduction (In-Camera Red-Eye Fix).”

If the camera detects red eye while saving an image, the affected area is processed to reduce red-eye before the image is saved.

Note the following when shooting:

- More time than usual is required to save images.
- Red-eye reduction may not produce the desired results in all situations.
- In rare cases, areas of the image that are not affected by red-eye may be processed by red-eye reduction. In these cases, select another flash mode and take the picture again.

Using the Self-timer

The camera's self-timer can release the shutter about 10 seconds after you press the shutter-release button. The self-timer is useful when you want to be in the picture you are taking, or when you want to avoid the effects of camera shake that occur when you press the shutter-release button. When using the self-timer, use of a tripod is recommended.

- 1 Press the multi selector ◀ (⏸ self-timer).



- 2 Press ▲ or ▼ to select **ON** and then press the **OK** button.

- ⏸10 is displayed.
- If a setting is not applied by pressing the **OK** button within a few seconds, the selection is canceled.
- When **Pet portrait** is selected in scene mode,  (pet portrait auto release) is displayed (📖 38). The self-timer cannot be used.

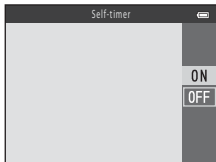

- 3 Frame the picture and then press the shutter-release button halfway.

- Focus and exposure are set.

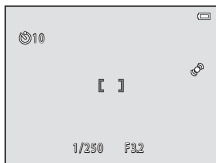

4 Press the shutter-release button the rest of the way down.

- The self-timer starts, and the number of seconds remaining before the shutter is released is displayed in the monitor. The self-timer lamp flashes while the timer is counting down. About one second before the shutter is released, the lamp stops flashing and glows steadily.
- When the shutter is released, the self-timer is set to **OFF**.
- To stop the timer before a picture is taken, press the shutter-release button again.



Features That Cannot Be Used Simultaneously

Some settings cannot be used with other functions ( 56).

Using Macro Mode

When using macro mode, the camera can focus on objects as close as about 10 cm (4 in.) from the lens.

This feature is useful when taking close-up pictures of flowers and other small subjects.

- 1 Press the multi selector ▼ (🌸 macro mode).



- 2 Press ▲ or ▼ to select **ON** and then press the **OK** button.

- 🌸 is displayed.
- If a setting is not applied by pressing the **OK** button within a few seconds, the selection is canceled.

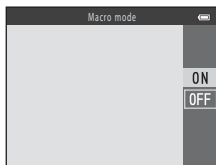

- 3 Use the zoom control to set the zoom position to a position where 🌸 and the zoom indicator turn green.

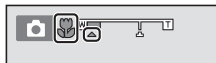

- How close you can be to the subject when shooting depends on the zoom position. When the zoom position is set to a position where 🌸 and the zoom indicator turn green, the camera can focus on subjects as close as about 30 cm (1 ft) from the lens. When the zoom position is set to a wide-angle position relative to ▲, the camera can focus on subjects as close as about 10 cm (4 in.) from the lens.

Notes About Using the Flash

The flash may be unable to light the entire subject at distances of less than 50 cm (1 ft 8 in.).

Autofocus

When shooting still images in macro mode, the camera focuses continuously until the shutter-release button is pressed halfway to lock the focus. You may hear the sound of the camera focusing.

The Macro Mode Setting

- Macro mode cannot be used when using certain shooting modes. → “Default Settings” (📖 52)
- The macro mode setting applied in  (auto) mode is saved in the camera’s memory even after the camera is turned off.

Adjusting Brightness (Exposure Compensation)

You can adjust overall image brightness.

- 1 Press the multi selector ► (☒ exposure compensation).



- 2 Press ▲ or ▼ to select a compensation value.

- To make the image brighter, apply positive (+) exposure compensation.
- To make the image darker, apply negative (-) exposure compensation.

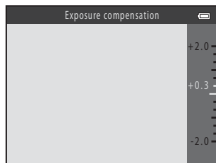

- 3 Press the (OK) button to apply the compensation value.

- If you do not press the (OK) button within a few seconds, the setting is applied and the menu disappears.
- When an exposure compensation value other than **0.0** is applied, ☒ and the value are displayed in the monitor.

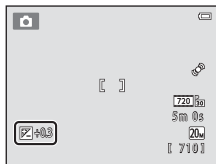

- 4 Press the shutter-release button to take a picture.







































































- To turn off exposure compensation, return to step 1 and change the value to **0.0**.

Exposure Compensation Value

The exposure compensation value applied in  (auto) mode is saved in the camera's memory even after the camera is turned off.

Default Settings

Default settings for each shooting mode are described below.

	Flash ( 44)	Self-timer ( 47)	Macro ( 49)	Exposure compensation ( 51)
 (easy auto;  32)	 AUTO ¹	Off	Off ²	0.0
 (smart portrait;  39)	 AUTO ³	Off ⁴	Off ⁵	0.0
 (auto;  42)	 AUTO	Off	Off	0.0
Scene				
 ( 34)	 	Off	Off ⁵	0.0
 ( 34)	 ⁵	Off	Off ⁵	0.0
 ( 34)	 ⁵	Off ⁵	Off ⁵	0.0
 ( 35)	  ⁶	Off	Off ⁵	0.0
 ( 35)	  ⁷	Off	Off ⁵	0.0
 ( 35)	 AUTO	Off	Off ⁵	0.0
 ( 35)	 AUTO	Off	Off ⁵	0.0
 ( 35)	 ⁵	Off	Off ⁵	0.0
 ( 35)	 ⁵	Off	Off ⁵	0.0
 ( 35)	 ⁵	Off	Off ⁵	0.0
 ( 36)	 ⁵	Off	On ⁵	0.0
 ( 36)	 ⁵	Off	On ⁵	0.0
 ( 36)	 ⁵	Off	Off	0.0
 ( 37)	 ⁵	Off ⁵	Off ⁵	0.0 ⁵
 ( 37)	 ⁵	Off	Off	0.0
 ( 37)	 ⁵	Off	Off ⁵	0.0
 ( 37)	 ⁵	Off	Off	0.0
 ( 38)	 ⁵	 ⁸	Off	0.0

- 1 You can select AUTO (auto) or (off). When AUTO (auto) is selected, the camera automatically selects the flash mode appropriate for the scene it has selected.
- 2 The setting cannot be changed. Automatically changes to macro mode when the camera selects **Close-up**.
- 3 Cannot be used when **Blink proof** is set to **On**.
- 4 Can be set when **Smile timer** is set to **Off**.
- 5 The setting cannot be changed.
- 6 The setting cannot be changed. The flash mode setting is fixed at fill flash with slow sync and red-eye reduction.
- 7 Slow sync with red-eye reduction flash mode may be used.
- 8 The self-timer cannot be used. You can turn the pet portrait auto release (38) on and off.

Features That Cannot Be Used Simultaneously

Some settings cannot be used with other functions (56).

Features That Can Be Set by Pressing the MENU Button (Shooting Menu)

When shooting, you can set the following features by pressing the **MENU** button.

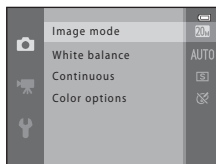









The features that are available vary with the shooting mode, as shown below.

	Easy auto mode	Scene	Smart portrait	Auto mode
Image mode*	✓	✓	✓	✓
White balance	-	-	-	✓
Continuous	-	-	-	✓
Color options	-	-	-	✓
Skin softening	-	-	✓	-
Smile timer	-	-	✓	-
Blink proof	-	-	✓	-

* If you change the image mode setting, the new setting is applied to all shooting modes.

Available Shooting Menus

Option	Description	
Image mode	Allows you to select the combination of image size and image quality used when saving images. The default setting is 20M 5152x3864 .	 22
White balance	Allows you to adjust white balance to suit the light source in order to make the colors in images match what you see with your eye. The available settings are Auto (default setting), Preset manual , Daylight , Incandescent , Fluorescent , Cloudy , and Flash .	 24
Continuous	Allows you to capture a series of images. The available settings are Single (default setting), Continuous , BSS , and Multi-shot 16 .	 27
Color options	Allows you to change the color tones of images. The available settings are Standard color (default setting), Vivid color , Black-and-white , Sepia , and Cyanotype .	 28
Skin softening	Enables skin softening. Makes the skin tones in people's faces smoother. The default setting is On .	 29
Smile timer	When On (default setting) is selected, the camera detects people's faces and then automatically releases the shutter whenever a smile is detected.	 30
Blink proof	When On is selected, the camera automatically releases the shutter twice each time a picture is taken. Of the two shots, the image in which the subject's eyes are more open compared to the other shot is saved. The flash cannot be used when On is selected. The default setting is Off .	 30

Features That Cannot Be Used Simultaneously

Some settings cannot be used with other functions ( 56).

Features That Cannot Be Used Simultaneously

Certain features cannot be used simultaneously.

Restricted function	Option	Description
Flash mode	Continuous (📖 55)	When Continuous , BSS , or Multi-shot 16 is selected, the flash cannot be used.
	Blink proof (📖 55)	When Blink proof is set to On , the flash cannot be used.
Self-timer	Smile timer (📖 55)	When Smile timer is used for shooting, the self-timer cannot be used.
Digital zoom	Continuous (📖 55)	When Multi-shot 16 is selected, digital zoom cannot be used.
Image mode	Continuous (📖 55)	When Multi-shot 16 is selected, the Image mode setting is fixed at 5M (image size: 2560 × 1920 pixels).
White balance	Color options (📖 55)	When using Black-and-white , Sepia , or Cyanotype , the White balance setting is fixed at Auto .
Continuous	Self-timer (📖 47)	When using the self-timer, Continuous is fixed at Single .
Electronic VR	Continuous (📖 55)	When Continuous , BSS , or Multi-shot 16 is selected, Electronic VR is disabled.
Motion detection	Flash mode (📖 44)	When the flash fires, Motion detection is disabled.
	Continuous (📖 55)	When Multi-shot 16 is selected, Motion detection is disabled.
Shutter sound	Continuous (📖 55)	When Continuous , BSS , or Multi-shot 16 is selected, the shutter sound is not heard.

Using Face Detection

In the following shooting modes, the camera uses face detection to automatically focus on people's faces. If the camera detects more than one face, a double border is displayed around the face that the camera focuses on, and single borders are displayed around the other faces.

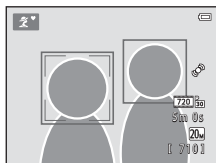

Shooting mode	Number of faces that can be detected	Focus area (double border)
Portrait and Night portrait in ☺ (easy auto) mode (📖 32)	Up to 12	The face closest to the camera
Portrait (📖 34) and Night portrait (📖 35) in scene mode		
Pet portrait (when Pet portrait auto release is set to OFF ; 📖 38) in scene mode	Up to 12 ¹	The face closest to the camera ²
Smart portrait mode (📖 39)	Up to 3	The face closest to the center of the frame

¹ If the camera detects both people and pets in the same shot, the camera can detect up to 12 faces.

² If the camera detects a person's face and a pet's face in the same shot, it focuses on the pet's face.

- If no faces are detected when the shutter-release button is pressed halfway, the camera focuses on the subject in the center of the frame.
- You may hear the sound of the camera focusing.

Notes About Face Detection

- The camera's ability to detect faces depends on a variety of factors, including whether or not the subject is facing the camera. Additionally, the camera may be unable to detect faces in the following situations:
 - When faces are partially hidden by sunglasses or otherwise obstructed
 - When faces take up too much or too little of the frame
- When the frame includes more than one person's face, the faces detected by the camera and the face on which the camera focuses depend upon a variety of factors, including the direction in which the faces are looking.
- In some rare cases, such as those described in "Subjects Not Suitable for Autofocus" (📖 60), the subject may not be in focus even though the double border turns green. Should this occur, use another mode, such as  (auto) mode, and try focus lock shooting (📖 59) by focusing on another subject that is the same distance from the camera.

Focus Lock

When the camera focuses on an object in the center of the frame, you can use focus lock to focus on an off-center subject.

Use the following procedure when taking pictures using  (auto) mode.

1 Aim the camera at the subject so that the subject is in the center of the frame.

2 Press the shutter-release button halfway.

- Confirm that the focus area turns green.
- Focus and exposure are locked.

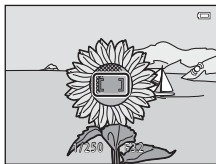

3 Continue holding down the shutter-release button halfway and recompose the picture.

- Be sure to maintain the same distance between the camera and the subject.

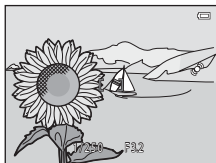



4 Press the shutter-release button the rest of the way down to take the picture.



Subjects Not Suitable for Autofocus

The camera may not focus as expected in the following situations. In some rare cases, the subject may not be in focus despite the fact that the focus area or the focus indicator turns green:

- Subject is very dark
- Objects of sharply differing brightness are included in the scene (e.g. the sun behind the subject makes that subject appear very dark)
- No contrast between the subject and surroundings (e.g. a portrait subject, wearing a white shirt, is standing in front of a white wall)
- Several objects are at different distances from the camera (e.g. an animal inside a cage)
- Subjects with repeating patterns (window blinds, buildings with multiple rows of similarly shaped windows, etc.)
- Subject is moving rapidly

In the situations noted above, try pressing the shutter-release button halfway to refocus several times, or select  (auto) mode and use focus lock ( 59) to take the picture by first focusing on an object that is the same distance from the camera as the desired subject.

Playback Features

This chapter describes the features that are available when playing back images.

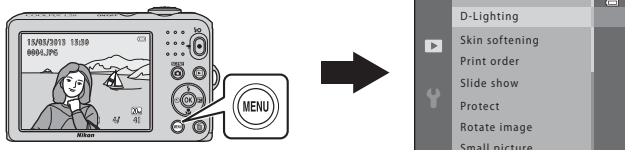

Playback Zoom	62
Thumbnail Display, Calendar Display.....	63
Features That Can Be Set by Pressing the MENU Button (Playback Menu) ...	64
Connecting the Camera to a TV, Computer, or Printer ...	65
Using ViewNX 2.....	67
Installing ViewNX 2.....	67
Transferring Images to the Computer	70
Viewing Images.....	72

Playback Zoom

Rotating the zoom control to **T** (Q) in full-frame playback mode (📖 26) zooms in on the center of the image displayed in the monitor.

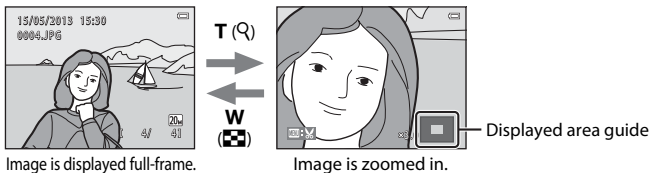

- You can change the zoom ratio by rotating the zoom control to **W** (📐) or **T** (Q). Images can be zoomed up to approx. 10x.
- To view a different area of the image, press the multi selector ▲, ▼, ◀, or ▶.
- If you are viewing an image that was captured using face detection (📖 57) or pet detection (📖 38), the camera zooms in on the face detected at the time of shooting. If the camera detected multiple faces when the image was captured, press ▲, ▼, ◀, or ▶ to display a different face. To zoom in on an area of the image where there are no faces, adjust the zoom ratio and then press ▲, ▼, ◀, or ▶.
- You can crop the image and save the displayed area of the image as a separate file by pressing the **MENU** button (🍴10).
- Press the **OK** button to return to full-frame playback mode.

Thumbnail Display, Calendar Display

Rotating the zoom control to **W** (📏) in full-frame playback mode (📖 26) displays images in “contact sheets” of thumbnail images.

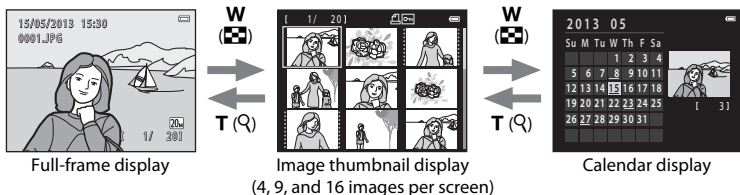









- You can view several images on one screen, making it easy to find the image you want.
- You can change the number of thumbnails displayed by rotating the zoom control to **W** (📏) or **T** (🔍).
- Press the multi selector ▲, ▼, ◀, or ▶ to select an image, and then press the **OK** button to display that image full-frame.
- When 16 thumbnails are displayed, rotate the zoom control to **W** (📏) to switch to calendar display.
- While using calendar display mode, press ▲, ▼, ◀, or ▶ to select a date and then press the **OK** button to display the first image captured on that day.

📌 Notes About Calendar Display

Images captured when the camera's date is not set are treated as images captured on January 1, 2013.

Features That Can Be Set by Pressing the MENU Button (Playback Menu)

When viewing images in full-frame playback mode or thumbnail playback mode, you can configure the menu operations listed below by pressing the **MENU** button.

Option	Description	
D-Lighting*	Allows you to create copies with enhanced brightness and contrast, brightening dark portions of an image.	 7
Skin softening*	The camera detects people's faces in images and creates a copy with softer facial skin tones.	 8
Print order	When using a printer to print images saved on the memory card, you can use the Print order function to select which images are printed, and how many copies of each image are printed.	 31
Slide show	Allows you to view images saved in the internal memory or on a memory card in an automatic slide show.	 34
Protect	Allows you to protect selected images from accidental deletion.	 35
Rotate image	Allows you to specify the orientation in which saved images are displayed with playback.	 37
Small picture*	Allows you to create a small copy of the current image. This feature is useful for creating copies for display on Web pages or e-mail attachments.	 9
Copy	Allows you to copy images between the internal memory and a memory card.	 38

* Images are edited and saved as separate files. Certain restrictions apply (6). For example, the same editing feature cannot be applied multiple times.

Connecting the Camera to a TV, Computer, or Printer

You can enhance your enjoyment of images and movies by connecting the camera to a TV, computer, or printer.

- Before connecting the camera to an external device, make sure the remaining battery level is sufficient and turn the camera off. For information about the connection methods and subsequent operations, refer to the documentation included with the device in addition to this document.

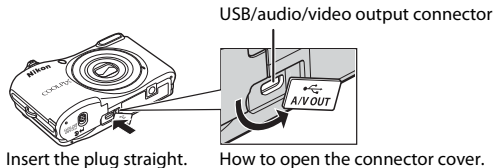

Viewing images on a TV

 12

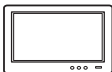

You can view the camera's images and movies on a TV.
Connection method: Connect the video and audio plugs of the optional audio/video cable to the TV's input jacks.

Viewing and organizing images on a computer

 67



If you transfer images to a computer, you can perform simple retouching and manage image data in addition to playing back images and movies.

Connection method: Connect the camera to the computer's USB input jack with the included USB Cable UC-E16.

- Before connecting to a computer, install ViewNX 2 on the computer using the included ViewNX 2 CD-ROM. For information about using the ViewNX 2 CD-ROM and transferring images to a computer, see page 67.

Printing images without using a computer

 15



If you connect the camera to a PictBridge-compatible printer, you can print images without using a computer.

Connection method: Connect the camera directly to the printer's USB input jack with the included USB cable.

Using ViewNX 2

ViewNX 2 is an all-in-one software package which enables you to transfer, view, edit and share images.

Install ViewNX 2 using the included ViewNX 2 CD-ROM.



Installing ViewNX 2

- An Internet connection is required.

Compatible Operating Systems

Windows

Windows 8, Windows 7, Windows Vista, Windows XP

Macintosh

Mac OS X 10.6, 10.7, 10.8

Refer to the Nikon website for details on system requirements, including the latest information on operating system compatibility.

1 Start the computer and insert the ViewNX 2 CD-ROM into the CD-ROM drive.

- Windows: If instructions for operating the CD-ROM are displayed in the window, follow the instructions to proceed to the installation window.
- Mac OS: When the **ViewNX 2** window is displayed, double-click the **Welcome** icon.

2 Select a language in the language selection dialog to open the installation window.

- If the desired language is not available, click **Region Selection** to choose a different region and then choose the desired language (the **Region Selection** button is not available in the European release).
- Click **Next** to display the installation window.

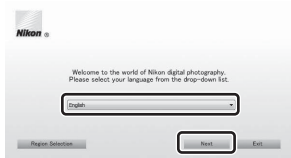

3 Start the installer.

- We recommend clicking **Installation Guide** in the installation window to check the installation help information and system requirements before installing ViewNX 2.
- Click **Typical Installation (Recommended)** in the installation window.

4 Download the software.

- When the **Software Download** screen is displayed, click **I agree - Begin download**.
- Follow the on-screen instructions to install the software.

5 Exit the installer when the installation completion screen is displayed.

- Windows: Click **Yes**.
- Mac OS: Click **OK**.

The following software is installed:

- ViewNX 2 (consisting of the three modules below)
 - Nikon Transfer 2: For transferring images to the computer
 - ViewNX 2: For viewing, editing, and printing transferred images
 - Nikon Movie Editor: For basic editing of transferred movies
- Panorama Maker (for creating a single panorama photo using a series of images shot in panorama assist scene mode)

6 Remove the ViewNX 2 CD-ROM from the CD-ROM drive.

Transferring Images to the Computer

1 Choose how images will be copied to the computer.

Choose one of the following methods:

- **Direct USB connection:** Turn the camera off and ensure that the memory card is inserted in the camera. Connect the camera to the computer using the included USB cable. Turn the camera on.
To transfer images that are saved in the camera's internal memory, remove the memory card from the camera before connecting it to the computer.

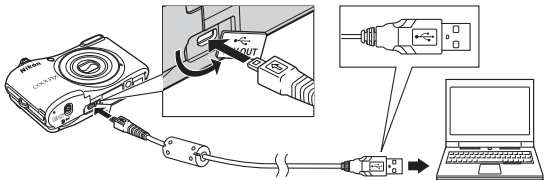

- **SD card slot:** If your computer is equipped with an SD card slot, the card can be inserted directly in the slot.
- **SD card reader:** Connect a card reader (available separately from third-party suppliers) to the computer and insert the memory card.

If a message is displayed prompting you to choose a program, select Nikon Transfer 2.

• When using Windows 7

If the dialog shown at right is displayed, follow the steps below to select Nikon Transfer 2.

- 1 Under **Import pictures and videos**, click **Change program**. A program selection dialog will be displayed; select **Import File using Nikon Transfer 2** and click **OK**.
- 2 Double-click **Import File**.



If the memory card contains a large number of images, it may take a while for Nikon Transfer 2 to start. Wait until Nikon Transfer 2 starts.

✓ Connecting the USB Cable

The connection may not be recognized if the camera is connected to the computer via a USB hub.

2 Transfer images to the computer.

- Confirm that the name of the connected camera or removable disk is displayed as the “Source” on the “Options” title bar of Nikon Transfer 2 (①).
- Click **Start Transfer** (②).

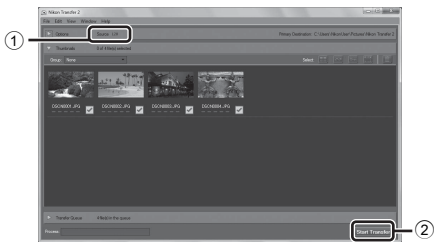

- At default settings, all the images on the memory card will be copied to the computer.

3 Terminate the connection.

- If the camera is connected to the computer, turn the camera off and disconnect the USB cable. If you are using a card reader or card slot, choose the appropriate option in the computer operating system to eject the removable disk corresponding to the memory card and then remove the card from the card reader or card slot.

Viewing Images

Start ViewNX 2.

- Images are displayed in ViewNX 2 when transfer is complete.
- Consult online help for more information on using ViewNX 2.



Starting ViewNX 2 Manually

- **Windows:** Double-click the **ViewNX 2** shortcut icon on the desktop.
- **Mac OS:** Click the **ViewNX 2** icon in the Dock.

Recording and Playing Back Movies

You can record movies by simply pressing the  movie-record button.

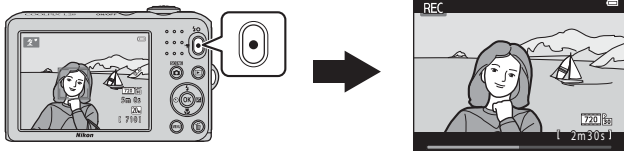

Recording Movies	74
Playing Back Movies.....	78

Recording Movies

You can record movies by simply pressing the **●** (movie-record) button.

- When no memory card is inserted (i.e., when using the camera's internal memory), **Movie options** (book 77, icon 40) is set to **480p** **480/30p**. **720p** **720/30p** cannot be selected.

1 Display the shooting screen.

- The icon for the selected movie option is displayed. The default setting is **720p** **720/30p** (book 77).
- When recording movies, the angle of view (i.e., the area visible in the frame) is narrower compared to that of still images.

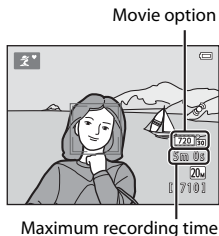

2 Press the **●** (movie-record) button to start movie recording.

- The camera focuses on the subject in the center of the frame. Focus areas are not displayed during recording.
- When **Movie options** is set to **720p** **720/30p**, the monitor display changes to a 16:9 aspect ratio when recording movies.
- If **Photo info in Monitor settings** (book 82) in the setup menu is set to **Movie frame+auto info**, the area that is visible in the movie can be confirmed before movie recording starts.
- REC** is displayed while saving to the internal memory.

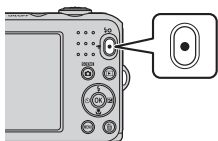



3 Press the **●** (movie-record) button again to end recording.

Notes About Saving Data

After taking pictures or recording movies, the number of exposures remaining or the remaining recording time flashes while images or movies are being saved. **Do not open the battery-chamber/memory card slot cover.** Image and movie data could be lost and the camera or memory card could be damaged.

Notes About Movie Recording



- Memory cards with an SD Speed Class rating of 6 or faster are recommended when recording movies (:19). Movie recording may stop unexpectedly when memory cards with a lower Speed Class rating are used.
- Image quality degrades when digital zoom is used. When recording ends, digital zoom turns off.
- The sounds of zoom control operation, zoom, autofocus lens drive movement, and aperture operation when brightness changes may be recorded.
- Smear (:3) visible in the monitor with movie recording is recorded with movies. Avoiding bright objects such as the sun, reflections of the sun, and electric lights is recommended.
- Depending on the distance to the subject or the amount of zoom applied, subjects with repeating patterns (fabrics, lattice windows, etc.) may have colored stripes (interference patterns, moire, etc.) in them during movie recording and playback. This occurs when the pattern in the subject and the layout of the image sensor interfere with each other; it is not a malfunction.

Camera Temperature





- The camera may become warm when recording movies for an extended period of time or when the camera is used in a hot area.
- If the inside of the camera becomes extremely hot when recording movies, the camera will automatically stop recording after 10 seconds.
The amount of time remaining until the camera stops recording ( 10 s) is displayed.
After the camera stops recording, it turns itself off.
Leave the camera off until the inside of the camera has cooled.

Notes About Autofocus

Autofocus may not perform as expected ( 60). Should this occur, try the following:

1. Set **Autofocus mode** in the movie menu to **AF-S Single AF** (default setting) before starting movie recording ( 77,  42).
2. Frame another subject—positioned at the same distance from the camera as the intended subject—in the center of the frame, press the  (movie-record) button to start recording, and then modify the composition.

Functions Available with Movie Recording

- The exposure compensation, white balance, and color options settings for the current shooting mode are also applied with movie recording. The tone that results from using scene mode ( 33) is also applied to movies. When macro mode is enabled, movies of subjects closer to the camera can be recorded. Confirm settings before starting movie recording.
- The self-timer ( 47) can be used. Set the self-timer and then press the  (movie-record) button to start recording a movie after 10 seconds.
- The flash does not fire.
- Press the **MENU** button to select the  (movie) menu icon and adjust movie menu settings before starting movie recording ( 77).

More Information





- Maximum Movie Recording Time →  41
- File and Folder Names →  65

Features That Can Be Set by Pressing the MENU Button (Movie Menu)

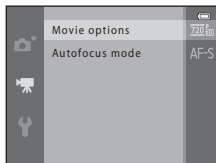
Enter shooting mode → MENU button →  menu icon →  button

The following settings can be changed.



Option	Description	
Movie options	Determines the type of movie that will be recorded. The default setting is  720/30p . When no memory card is inserted (i.e., when using the camera's internal memory), the default setting is  480/30p .	 40
Autofocus mode	When AF-S Single AF (default setting) is selected, focus is locked when movie recording begins. When AF-F Full-time AF is selected, the camera focuses continuously while recording. When AF-F Full-time AF is selected, the sound of the camera focusing may be heard in recorded movies. If you want to prevent the sound of the camera focusing from being recorded, select AF-S Single AF .	 42

Playing Back Movies

Press the  button to enter playback mode.

Movies are indicated by the movie options icon ( 77).

Press the  button to play back movies.





Movie options

















Paused



Functions Available During Playback

Playback controls are displayed at the top of the monitor.

Press the multi selector  or  to select a control. The operations described below are available.

Function	Icon	Description
Rewind		Hold down the  button to rewind the movie.
Advance		Hold down the  button to advance the movie.
Pause		Press the  button to pause playback. The following operations can be performed while playback is paused using the controls displayed at the top in the monitor.
		 Press the  button to rewind the movie by one frame. Hold down the  button for continuous rewinding.
		 Press the  button to advance the movie by one frame. Hold down the  button for continuous advancing.
		 Press the  button to resume playback.
End		Press the  button to return to full-frame playback mode.

Adjusting volume

Use the zoom control during playback.



Volume indicator

Deleting movies

To delete a movie, select the desired movie in full-frame playback mode (📖 26) or thumbnail playback mode (📖 63) and then press the 🗑️ button (📖 28).

✔ Notes About Playing Back Movies

This camera cannot play back movies recorded with another make or model of digital camera.



A series of ten horizontal dashed lines spanning the width of the page, intended for handwriting practice.

General Camera Setup

This chapter describes the various settings that can be adjusted in the  setup menu.

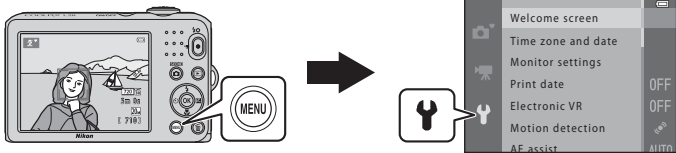









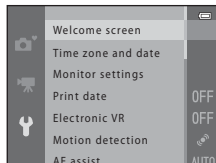



For further details about each setting, refer to “The Setup Menu” in the Reference Section (43).









Features That Can Be Set by Pressing the MENU Button (Setup Menu)

Press the MENU button →  (setup) menu icon →  button

You can change the following settings by selecting the  menu icon when the menu is displayed.



Option	Description	
Welcome screen	Allows you to select whether or not a welcome screen is displayed when the camera is turned on.	 43
Time zone and date	Allows you to set the camera clock.	 44
Monitor settings	Allows you to adjust photo information display and monitor brightness settings.	 47
Print date	Allows you to imprint the shooting date and time on images.	 49
Electronic VR	Allows you to select the electronic vibration reduction setting used when shooting still images.	 50
Motion detection	Allows you to set whether or not the camera automatically increases the shutter speed to reduce blurring caused by camera shake when motion is detected when shooting still images.	 52
AF assist	Allows you to enable and disable the AF-assist illuminator.	 53
Sound settings	Allows you to adjust sound settings.	 54
Auto off	Allows you to set the amount of time that passes before the monitor turns off to save power.	 55
Format memory/ Format card	Allows you to format the internal memory or the memory card.	 56

Option	Description	
Language	Allows you to change the camera's display language.	 57
Video mode	Allows you to adjust TV-connection settings.	 58
Blink warning	Allows you to set whether or not closed eyes are detected when taking pictures of people using face detection.	 58
Eye-Fi upload	Allows you to set whether or not to enable the function for sending images to a computer using a commercially available Eye-Fi card.	 60
Reset all	Allows you to reset the camera's settings to their default values.	 61
Battery type	Change this setting to match the type of batteries that are inserted in the camera.	 64
Firmware version	Allows you to confirm the camera's firmware version.	 64



A series of ten horizontal dashed lines spanning the width of the page, intended for handwriting practice.



Reference Section

The Reference Section provides detailed information and hints about using the camera.

Shooting

Using Panorama Assist 2

Playback

Editing Still Images 5

Connecting the Camera to a TV (Viewing Images on a TV) 12

Connecting the Camera to a Printer (Direct Print) 14

Menu

The Shooting Menu (for (Auto) Mode) 22

The Smart Portrait Menu 29

The Playback Menu 31

The Movie Menu 40

The Setup Menu 43

Additional Information











File and Folder Names 65

Optional Accessories 66

Error Messages 67













Using Panorama Assist

The camera focuses on the subject in the center of the frame. Use a tripod for the best results.

Enter shooting mode →  (shooting mode) button →  (second icon from the top*)
→   , , ,  →  (panorama assist) →  button

* The icon of the last scene selected is displayed.

1 Use the multi selector to select the direction and press the button.

- Panorama direction icons are displayed to show the direction in which images will be joined. Select the direction in which images will be joined in the completed panorama; right (), left (), up (), or down ().
- The yellow panorama direction icon () is displayed according to the direction you selected. Press the  button to confirm the selection. The icon changes to the white fixed-direction icon ().
- If necessary, apply flash mode () 44), self-timer () 47), macro mode () 49), and exposure compensation () 51) settings with this step.
- Press the  button again to select a different direction.



2 Frame the first portion of the panorama scene and take the first picture.

- About one third of the image is displayed as translucent.



3 Take the next picture.

- Frame the next image so that one third of the frame overlaps the first image, and press the shutter-release button.
- Repeat this process until the necessary number of images has been taken to complete the scene.



4 Press the **OK** button when shooting is complete.

- The camera returns to step 1.

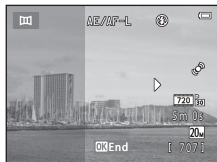

✓ Notes About Panorama Assist

- Flash mode, self-timer, macro mode, and exposure compensation settings cannot be adjusted after the first picture is taken. Images cannot be deleted, nor can zoom or **Image mode** settings (🔑22) be adjusted after the first picture has been taken.
- Shooting for the panorama series is terminated if the auto off function (🔑55) initiates standby mode when shooting. Setting the time allowed to elapse before the auto off function is enabled to a longer setting is recommended.



AE/AF-L Indicator

In **Panorama assist** scene mode, exposure, white balance, and focus for all images in a panorama are fixed at the values for the first image in each series.

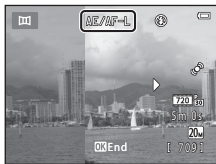
When the first picture is taken, **AE/AF-L** is displayed to indicate that exposure, white balance, and focus are locked.



Combining Images to Make a Panorama (Panorama Maker)

- Transfer images to a computer ( 70) and use Panorama Maker to join multiple images to make a single panorama.
- Install Panorama Maker from the included ViewNX 2 CD-ROM ( 67).
- For more information about using Panorama Maker, refer to the on-screen instructions and help information contained in Panorama Maker.

More Information

File and Folder Names →  65



Editing Still Images

Editing Features

You can use the following features to edit your images. Edited images are saved as separate files (🔗65).

Editing function	Description
D-Lighting (🔗7)	Allows you to create a copy of the current image with enhanced brightness and contrast, brightening dark portions of the image.
Skin softening (🔗8)	Allows you to make the skin tones in people's faces smoother.
Small picture (🔗9)	Allows you to create a small copy of images suitable for use as e-mail attachments.
Crop (🔗10)	Allows you to crop a portion of the image. Use to zoom in on a subject or arrange a composition.

Notes About Image Editing

- This camera cannot edit images captured with another make or model of digital camera.
- Images captured when **Image mode** () is set to **5120x2880** cannot be edited using the skin softening function ()
- If no people's faces are detected in an image, a copy cannot be created using the skin softening function ()
- Edited copies created with this camera may not be displayed properly on another make or model of digital camera. It may also be impossible to transfer them to a computer using another make or model of digital camera.
- Editing functions are not available when there is not enough free space in the internal memory or on the memory card.



Restrictions on Image Editing

When an edited copy is further modified with another editing function, check the following restrictions.

Editing function used	Editing functions that can be added
D-Lighting	The skin softening, small picture, or crop function can be added.
Skin softening	The D-Lighting, small picture, or crop function can be added.
Small picture Crop	Another editing function cannot be added.

- Copies created with editing functions cannot be further edited with the same function used to create them.
- When combining the small picture or crop function and another editing function, use the small picture and crop functions after other editing functions have been applied.
- You can apply skin softening to images that were captured using skin softening ()



Original and Edited Images

- Copies created with editing functions are not deleted if the original images are deleted. The original images are not deleted if copies created with editing functions are deleted.
- Edited copies are saved with the same shooting date and time as the original.
- Print order () and protect settings () do not remain effective in edited copies.

D-Lighting: Enhancing Brightness and Contrast

Press the  button (playback mode) → MENU button → D-Lighting →  button

You can create a copy of the current image with enhanced brightness and contrast, brightening dark portions of an image.

Press the multi selector  or  to select **OK** and then press the  button.

- The original version is displayed on the left and an example of the edited version is displayed on the right.
- A new, edited copy is saved as a separate image.
- Copies created with this feature are indicated by  displayed during playback.

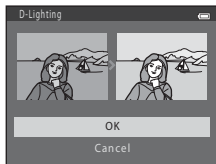



More Information

File and Folder Names → 65

Skin Softening: Softening Skin Tones

Press the  button (playback mode) → MENU button → Skin softening →  button



The camera detects people's faces in images and creates a copy with softer facial skin tones.

1 Press the multi selector  or  to select the degree of softening and then press the  button.

- The confirmation dialog is displayed with the face to which the effect was applied enlarged in the center of the monitor.
- To exit without saving the copy, press .



2 Check the preview of the copy and then press the  button.

- Skin tones of up to 12 faces, in the order of that closest to the center of the frame, are softened.
- If more than one face was processed, press  or  to display a different face.
- Press the MENU button to adjust the degree of softening. The monitor display returns to that shown in step 1.
- Edited copies are saved as separate images, and  is displayed when you play them back.



Notes About Skin Softening

Depending upon the direction in which faces are looking, or the brightness of faces, the camera may be unable to accurately detect faces, or the skin softening function may not perform as expected.



More Information

File and Folder Names → 65

Small Picture: Reducing the Size of an Image

Press the  button (playback mode) → MENU button → Small picture →  button

You can create a small copy of the current image.

- 1 Press the multi selector  or  to select the desired copy size and then press the  button.

- For images captured at an **Image mode** () setting of  **5120x2880**, only **640x360** is displayed.

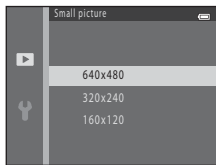

- 2 Select **Yes** and then press the  button.

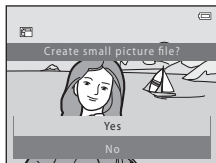

- A new, edited copy is saved as a separate image with a compression ratio of 1:16.
- Copies created with this feature are smaller than other images when displayed during playback, and are indicated by .



More Information

File and Folder Names → 65

Crop: Creating a Cropped Copy





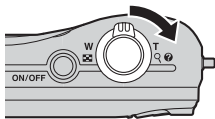

You can create a copy containing only the portion visible in the monitor when  is displayed with playback zoom ( 62) enabled.

1 Rotate the zoom control to **T** () in full-frame playback mode (26) to zoom in on the image.

- To crop an image displayed in “tall” (portrait) orientation, zoom in on the image until the black bars displayed on the both sides of the monitor disappear. The cropped image is displayed in landscape orientation. To crop the image in its current “tall” (portrait) orientation, first use the **Rotate image** option ( 37) to rotate the image so that it is displayed in landscape orientation. Next, enlarge the image for cropping, crop the image, and then rotate the cropped image back to “tall” (portrait) orientation.



2 Refine crop composition.

- Rotate the zoom control to **T** () or **W** () to adjust the zoom ratio.
- Press the multi selector , , , or  to scroll the image so that only the portion to be copied is visible in the monitor.

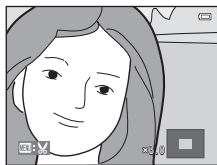

3 Press the **MENU** button.

4 Use the multi selector to select **Yes** and then press the **OK** button.

- A new, cropped copy is saved as a separate image.
- Copies created with this feature are indicated by  displayed during playback.

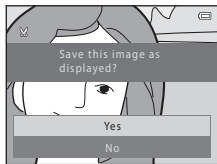

Image Size

- As the area to be saved is reduced, the image size (pixels) of the cropped copy is also reduced.
- Images cropped to an image size of 320 × 240 or 160 × 120 are smaller than other images when displayed during playback.



More Information

File and Folder Names → 65

Connecting the Camera to a TV (Viewing Images on a TV)

Connect the camera to a TV using an optional audio/video cable (❷❶❶) to play back images or movies on the TV.

1 Turn off the camera.

2 Connect the camera to the TV.

- Connect the yellow plug of the audio/video cable to the video-in jack and the white plug to the audio-in jack on the TV.

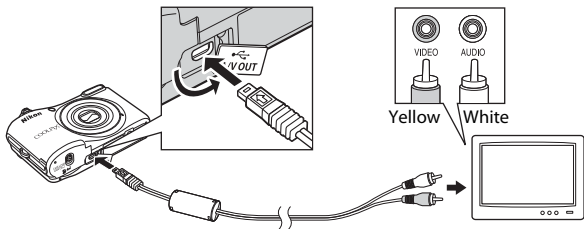

3 Set the TV's input to external video input.

- See your TV's documentation for details.

4 Hold down the  button to turn on the camera.

- The camera enters playback mode and images are displayed on the TV.
- While connected to the TV, the camera monitor remains off.

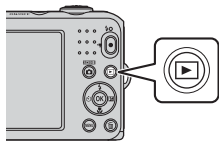

Notes About Connecting the Cable

When connecting the cable, be sure that the camera connector is properly oriented, do not insert the cable at an angle, and do not use excessive force. When disconnecting the cable, do not pull the connector at an angle.

If the Images Are Not Displayed on the TV

Be sure that the camera's video mode setting in the **Video mode** (58) under the setup menu conforms to the standard used by your TV.

Connecting the Camera to a Printer (Direct Print)

Users of PictBridge-compatible (📷20) printers can connect the camera directly to the printer and print images without using a computer. Follow the procedures below to print images.

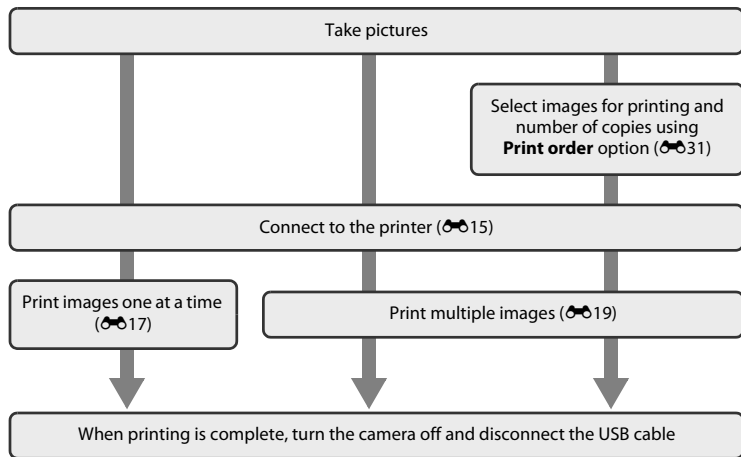

Notes About Power Source

- When connecting the camera to a printer, use batteries with a sufficient amount of charge remaining to prevent the camera from turning off unexpectedly.
- If the AC Adapter EH-65A (available separately) is used, this camera can be powered from an electrical outlet. Do not use any other make or model of AC adapter as it may cause the camera to heat up or malfunction.

Printing Images

In addition to printing images transferred to a computer from your personal printer and printing over a direct camera-to-printer connection, the following options are also available for printing images saved on the memory card:

- Inserting a memory card into a DPOF-compatible printer's card slot
- Taking a memory card to a digital photo lab

When using these methods to print, you can use the **Print order** option in the playback menu to specify which images will be printed and how many copies of each image will be printed, and save these settings on the memory card (31).

Connecting the Camera to a Printer

- 1 Turn off the camera.
 - 2 Turn on the printer.
 - Check printer settings.
-

3 Connect the camera to the printer using the included USB cable.

- Be sure that connectors are properly oriented, do not insert the cable at an angle, and do not use excessive force. When disconnecting the cable, do not remove the cable at an angle.

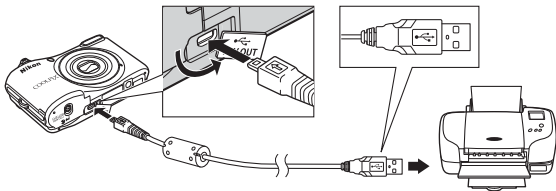

4 Turn on the camera.

- When properly connected, the **PictBridge** startup screen is displayed in the camera monitor, followed by the **Print selection** screen.



Printing Individual Images

After properly connecting the camera to the printer (🔌15), follow the procedures described below to print an image.

1 Use the multi selector to select the desired image and then press the **OK** button.

- To make it easier to select images, rotate the zoom control to **W** (📷) to switch to 6-image thumbnail playback mode. Rotate the zoom control to **T** (📄) to switch to full-frame playback mode.



2 Select **Copies** and then press the **OK** button.

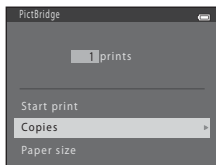

3 Press **▲** or **▼** to select the desired number of copies (up to nine) and then press the **OK** button.

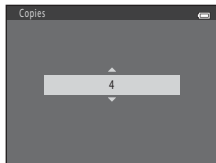

- 4** Select **Paper size** and then press the **OK** button.

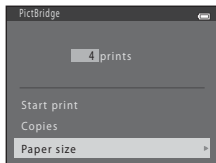

- 5** Select the desired paper size and then press the **OK** button.

- To specify paper size using settings on the printer, select **Default** in the paper size option.

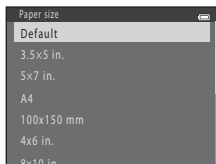

- 6** Select **Start print** and then press the **OK** button.

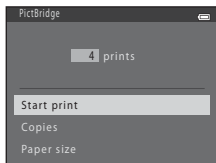

- 7** Printing begins.

- Monitor display returns to the print selection screen shown in step 1 when printing is complete.

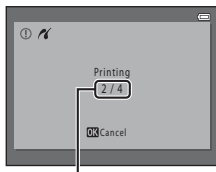

Current number of copies/
total number of copies

Printing Multiple Images

After properly connecting the camera to the printer (🔌15), follow the procedures described below to print multiple images.

1 When the **Print selection** screen is displayed, press the **MENU** button.

2 Use the multi selector to select **Paper size** and then press the **OK** button.

- To exit the print menu, press the **MENU** button.

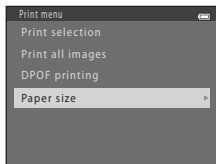

3 Select the desired paper size and then press the **OK** button.

- To specify paper size using settings on the printer, select **Default** in the paper size option.

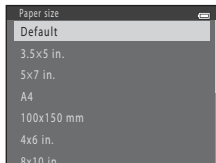

4 Select **Print selection**, **Print all images**, or **DPOF printing** and then press the **OK** button.

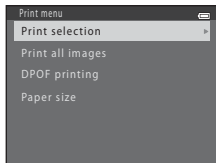

Print selection

Select which images will be printed (up to 99) and how many copies of each image will be printed (up to nine).

- Press the multi selector ◀ or ▶ to select images, and then press ▲ or ▼ to set the number of copies for each.
-  and the numeral indicating the number of copies to be printed are displayed below the images selected for printing. If no copies have been specified for an image, the selection is canceled.
- Rotate the zoom control to **T** (Q) to switch to full-frame playback mode or **W** (Z) to switch to 6-image thumbnail playback mode.
- Press the **OK** button when setting is complete.
- When the screen shown on the right is displayed, select **Start print** and then press the **OK** button to start printing. Select **Cancel** and then press the **OK** button to return to the print menu.

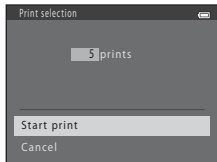

Print all images

One copy of each image saved in the internal memory, or on the memory card, is printed.

- When the screen shown on the right is displayed, select **Start print** and then press the **OK** button to start printing. Select **Cancel** and then press the **OK** button to return to the print menu.

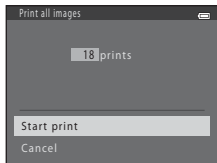

DPOF printing

Print images for which a print order was created using the **Print order** option (🔑31).

- When the screen shown on the right is displayed, select **Start print** and then press the **OK** button to start printing. Select **Cancel** and then press the **OK** button to return to the print menu.
- To view the current print order, select **View images** and then press the **OK** button. To print images, press the **OK** button again.

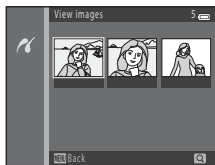
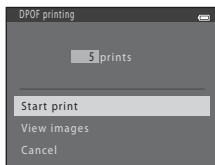

5 Printing begins.

- Monitor display returns to the print menu shown in step 2 when printing is complete.

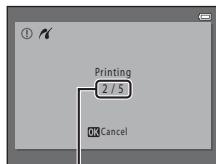

Current number of copies/
total number of copies

Paper Size

The camera supports the following paper sizes: **Default** (the default paper size for the printer connected to the camera), **3.5x5 in.**, **5x7 in.**, **100x150 mm**, **4x6 in.**, **8x10 in.**, **Letter**, **A3**, and **A4**. Only sizes supported by the printer are displayed.







The Shooting Menu (for (Auto) Mode)

Image Mode (Image Size and Quality)

Enter shooting mode → MENU button → Shooting menu → Image mode →  button

You can select the combination of image size and image quality (i.e., image compression ratio) that is used when saving images.

The higher the image mode setting, the larger the size at which images can be printed, and the lower the compression ratio, the higher the quality of the images, but the number of images that can be saved (23) is reduced.

Option ¹	Compression ratio	Aspect ratio	Print size ² (cm/in.)
 5152×3864★	Approx. 1:4	4:3	44 × 33/17 × 12.5
 5152×3864 (default setting)	Approx. 1:8	4:3	44 × 33/17 × 12.5
 3648×2736	Approx. 1:8	4:3	31 × 23/12 × 9
 2272×1704	Approx. 1:8	4:3	19 × 14/7.5 × 5.6
 1600×1200	Approx. 1:8	4:3	13 × 10/5.3 × 4
VGA 640×480	Approx. 1:8	4:3	5 × 4/2 × 1.5
  5120×2880	Approx. 1:8	16:9	43 × 24/17 × 9.6

¹ The total number of pixels captured, and the number of pixels captured horizontally and vertically. Example:  **5152×3864** = approx. 20 megapixels, 5152 × 3864 pixels

² Print size at an output resolution of 300 dpi.







Print sizes are calculated by dividing the number of pixels by printer resolution (dpi) and multiplying by 2.54 cm (1 in.). However, at the same image size, images printed at higher resolutions will be printed smaller than the size indicated, and those printed at lower resolutions will be printed larger than the size indicated.

Notes About Image Mode

- The setting is also applied to other shooting modes.
- Some settings cannot be used with other functions ( 56).

Number of Images That Can Be Saved

The following table lists the approximate number of images that can be saved on a 4 GB memory card. Note that due to JPEG compression, the number of images that can be saved varies greatly depending on the composition of the image, even when memory capacity and image mode settings remain constant. The number of images that can be saved may also vary depending on the type of memory card being used.

Image mode	Number of images that can be saved (4 GB)
 5152×3864★	350
 5152×3864 (default setting)	710
 3648×2736	1400
 2272×1704	3490
 1600×1200	6650
 640×480	26300
 5120×2880	950







- If the number of exposures remaining is 10,000 or more, the number of exposures remaining display shows “9999”.
- To confirm the number of images that can be saved in the internal memory (approx. 25 MB), remove the memory card from the camera, and then check the number of remaining exposures displayed in the monitor when shooting.

White Balance (Adjusting Hue)

Select  (auto) mode → MENU button → White balance →  button

The color of light reflected from an object varies with the color of the light source. The human brain is able to adapt to changes in the color of the light source, with the result that white objects appear white whether seen in the shade, direct sunlight, or under incandescent lighting. Digital cameras can mimic this adjustment by processing images according to the color of the light source. This is known as “white balance.” For natural colors, select a white balance setting that matches the light source before shooting.

Although **Auto** (the default setting) can be used under most types of lighting, white balance can be adjusted to suit the sky conditions or light source and achieve more natural color tones in the image.

Option	Description
AUTO Auto (default setting)	White balance is automatically adjusted to suit lighting conditions.
PRE Preset manual	Use when shooting under unusual lighting ( 25).
 Daylight	Use when shooting outdoors in direct sunlight.
 Incandescent	Use when shooting under incandescent lighting.
 Fluorescent	Use when shooting under fluorescent lighting.
 Cloudy	Use when shooting under overcast skies.
 Flash	Use when shooting with the flash.

The icon for the current setting is displayed in the monitor when the camera is in shooting mode ( 6). No icon is displayed when **Auto** is selected.

Using Preset Manual

Preset manual is used with unusual lighting or to compensate for light sources with a strong color cast when the desired effect has not been achieved with white balance settings like **Auto** and **Incandescent** (for example, to make images shot under a lamp with a red shade look as though they had been shot under white light).

Use the procedure below to measure the white balance value under the lighting used when shooting.

1 Prepare a white or gray-colored subject and then place it under the lighting that will be used when shooting.

2 Display the shooting menu (📖 54), use the multi selector to select **PRE Preset manual** in the **White balance** menu, and then press the **OK** button.

- The camera zooms in to the position for measuring white balance.

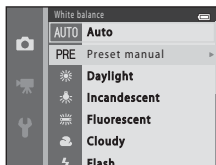

3 Select **Measure**.

- To apply the most recently measured white balance value, select **Cancel** and then press the **OK** button. The white balance setting is not measured again and the most recently measured value is set.

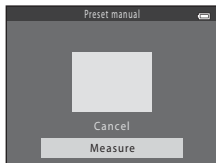

- 4 Frame the reference object in the measuring window.

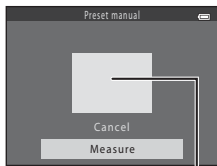

Measuring window

- 5 Press the **OK** button to measure a value for preset manual.
- The shutter is released and the new white-balance value is set. No image is saved.

✓ Notes About White Balance

- Some settings cannot be used with other functions (📖 56).
- Set the flash to **🚫** (off) when white balance is set to any setting other than **Auto** and **Flash** (📖 44).







✓ Notes About Preset Manual

A value for flash lighting cannot be measured with **Preset manual**. When shooting using the flash, set **White balance** to **Auto** or **Flash**.

Continuous Shooting

Select  (auto) mode → MENU button → Continuous → 

You can change settings to continuous or BSS (best shot selector).

Option	Description
 Single (default setting)	One picture is taken each time the shutter-release button is pressed.
 Continuous	While the shutter-release button is held all the way down, about six images are captured continuously at a rate of about 1.1 fps (when Image mode is set to  5152×3864).
BSS BSS (best shot selector)	The “best shot selector” is recommended when shooting with the flash off or the camera zoomed in, or in other situations in which inadvertent motion can result in blurred images. When BSS is on, the camera captures up to 10 images while the shutter-release button is held down. The sharpest image in the series is automatically selected and saved. <ul style="list-style-type: none">• BSS is best suited to shooting subjects that are not moving. When shooting moving subjects or when the composition of the picture changes while shooting, the desired results may not be achieved.
 Multi-shot 16	Each time the shutter-release button is pressed all the way down, the camera takes 16 shots at a rate of about 30 fps and arranges them in a single image. <ul style="list-style-type: none">• Image mode is fixed at  (image size: 2560 × 1920 pixels).• Digital zoom cannot be used. 

The icon for the current setting is displayed in the monitor when the camera is in shooting mode ( 6). No icon is displayed when **Single** is selected.

✓ Notes About Continuous Shooting

- When **Continuous**, **BSS**, or **Multi-shot 16** is selected, flash cannot be used. Focus, exposure, and white balance are fixed at the values determined with the first image in each series.
- The frame rate with continuous shooting may vary depending upon the current image mode setting, the memory card used, or shooting condition.
- Some settings cannot be used with other functions (📖 56).

✓ Notes About Multi-shot 16

Smear (👁️-3) visible in the monitor when shooting with **Multi-shot 16** enabled is saved with images. Avoiding bright objects such as the sun, reflections of the sun, and electric lights when shooting with **Multi-shot 16** enabled is recommended.

Color Options

Select 📷 (auto) mode → MENU button → Color options → Ⓜ️ button

You can adjust the colors when images are saved.

Option	Description
👁️ Standard color (default setting)	Use to achieve natural colors in your images.
👁️ VI Vivid color	Use to achieve vivid colors in your images.
👁️ BW Black-and-white	Use to save images in black-and-white.
👁️ SE Sepia	Use to save images in sepia tones.
👁️ C Cyanotype	Use to save images in cyan-blue monochrome.

The icon for the current setting is displayed in the monitor when the camera is in shooting mode (📖 6). When **Standard color** is selected, no icon is displayed. Color tones shown in the monitor when shooting change according to the selected color option.

✓ Notes About Color Options

Some settings cannot be used with other functions (📖 56).

The Smart Portrait Menu

- See “Image Mode (Image Size and Quality)” (🔑22) for information about **Image mode**.

Skin Softening

Select smart portrait mode → MENU button → Skin softening → ⓧ button

You can change skin softening settings.

Option	Description
 On (default setting)	When the shutter is released, the camera detects one or more person's faces (up to three), and processes the image to soften facial skin tones before saving the image.
OFF Off	Turns skin softening off.

The icon for the current setting is displayed in the monitor when the camera is in shooting mode (📖 6). No icon is displayed when **Off** is selected. The degree of skin softening effect cannot be confirmed on the subject on the shooting screen. Check the degree of skin softening performed in playback mode.

Smile Timer

Select smart portrait mode → MENU button → Smile timer →  button

The camera detects people's faces and then automatically releases the shutter whenever a smile is detected.



Option	Description
 On (default setting)	Enables the smile timer.
OFF Off	Turns the smile timer off.

The icon for the current setting is displayed in the monitor when the camera is in shooting mode ( 6). No icon is displayed when **Off** is selected.

Blink Proof

Select smart portrait mode → MENU button → Blink proof →  button

The camera automatically releases the shutter twice each time a picture is taken. Of the two shots, the image in which the subject's eyes are more open compared to the other shot is saved.

Option	Description	
 On	Enables the blink proof. Flash cannot be used when On is selected. If the camera saved an image in which the subject's eyes may have been closed, the dialog shown on the right is displayed for a few seconds.	
OFF Off (default setting)	Turns the blink proof off.	

The icon for the current setting is displayed in the monitor when the camera is in shooting mode ( 6). No icon is displayed when **Off** is selected.

The Playback Menu

- See “Editing Still Images” (🔧5) for information about image editing features.

Print Order (Creating a DPOF Print Order)

Press the  button (playback mode) → MENU button → Print order →  button

When printing images saved on the memory card using any of the following methods, the **Print order** option in the playback menu is used to create digital “print orders.”

- Inserting the memory card into a DPOF-compatible (🔧19) printer’s card slot.
- Taking the memory card to a digital photo lab.
- Connecting the camera to a PictBridge-compatible (🔧20) printer (🔧14). A print order can also be created for images saved in the internal memory if the memory card is removed from the camera.

- 1 Use the multi selector to select **Select images** and then press the  button.

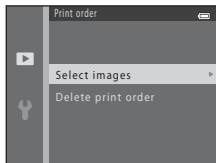

2 Select images (up to 99) and the number of copies (up to nine) of each.

- Press the multi selector ◀ or ▶ to select images, and then press ▲ or ▼ to set the number of copies for each.
-  and the numeral indicating the number of copies to be printed are displayed below the images selected for printing. If no copies have been specified for an image, the selection is canceled.
- Rotate the zoom control to **T** (🔍) to switch to full-frame playback mode. Rotate the zoom control to **W** (🖼️) to switch to 6-image thumbnail playback mode.
- Press the **OK** button when setting is complete.



3 Select whether or not to print shooting date and shooting information.

- Select **Date** and press the **OK** button to print the shooting date on all images in the print order.
- Select **Info** and press the **OK** button to print shooting information (shutter speed and aperture value) on all images in the print order.
- Select **Done** and press the **OK** button to complete the print order.

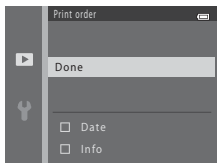

Images selected for printing are indicated by  during playback.

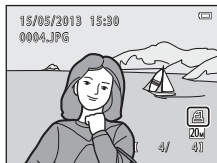

✓ Notes About Printing Shooting Date and Shooting Information

When the **Date** and **Info** settings are enabled in the print order option, shooting date and shooting information are printed on images when a DPOF-compatible printer (🔗19) that supports printing of shooting date and shooting information is used.

- Shooting information cannot be printed when the camera is connected to a DPOF-compatible printer via the included USB cable (🔗21).
- Note that the **Date** and **Info** settings are reset each time the **Print order** option is displayed.
- The date printed is that saved when the image was captured. Changing the camera's date using **Date and time** or **Time zone** in the **Time zone and date** option in the setup menu after an image has been captured has no effect on the date printed on the image.



📎 Canceling Existing Print Order

Select **Delete print order** in step 1 (🔗31) of "Print Order (Creating a DPOF Print Order)" and press the **OK** button to remove print marking from all images and cancel the print order.

📎 Print Date

When shooting date and time are imprinted on images using the **Print date** option (🔗49) in the setup menu, images are saved with shooting date and time imprinted on the image when they are captured. Images with the date imprinted on them can be printed from printers that do not support printing of the date on images.



Only the date and time imprinted on images with the print date option will be printed, even if the **Print order** date option is enabled.

Slide Show

Press the  button (playback mode) → MENU button → Slide show →  button







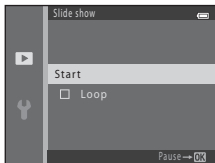

You can play back images, saved in the internal memory or on a memory card, one by one in an automated “slide show.”

1 Use the multi selector to select **Start** and then press the .

- To repeat the slide show automatically, select **Loop** and then press the  button before selecting **Start**. The check mark () is added to the loop option when enabled.





2 The slide show begins.

- While the slide show is in progress, press the multi selector  or  to display the next image or  or  to display the previous image. Press and hold  or  to fast forward, or  or  to fast rewind.
- To end or pause the slide show, press the .



3 End the slide show or restart it.



- The display at right appears when the last slide is displayed or the show is paused. Highlight  and press  to return to Step 1, or select  to restart the show.



Notes About Slide Show

- Only the first frame of movies is displayed.
- The maximum playback time is up to about 30 minutes even if **Loop** is enabled (55).

Protect

Press the  button (playback mode) → MENU button → Protect →  button

You can protect selected images from accidental deletion.

Select images to protect or cancel protection for previously protected images from the image selection screen.

→ “The Image Selection Screen” (36)

Note that formatting the camera’s internal memory or the memory card permanently deletes protected files (56).

Protected images are indicated by  during playback ( 8).

The Image Selection Screen

When using one of the following features, a screen like that shown on the right is displayed when selecting images.

- **Print order** > **Select images** (🔍31)
- **Protect** (🔒35)
- **Rotate image** (🔄37)
- **Copy** > **Selected images** (📄38)
- **Welcome screen** > **Select an image** (🔍43)
- **Delete** > **Erase selected images** (🗑28)
- **Print selection** when printing directly to a printer (🔍17, 🔍20)



Follow the procedures described below to select images.

1 Press the multi selector ◀ or ▶ to select an image.

- Rotate the zoom control (📖2) to **T** (🔍) to switch to full-frame playback mode or **W** (📄) to switch to 6-image thumbnail playback mode.
- When selecting an image for **Rotate image** or **Welcome screen**, or when using the **Print selection** screen to print individual images, only one image can be selected. Proceed to step 3.



2 Press ▲ or ▼ to select or deselect (or to specify the number of copies).

- When an image is selected, an icon is displayed below the image. Repeat steps 1 and 2 to select additional images.





3 Press the Ⓞ button to apply image selection.

- For some operations, such as when you have selected **Copy** > **Selected images**, a confirmation screen is displayed. Follow the instructions displayed in the monitor.

Rotate Image

Press the  button (playback mode) → MENU button → Rotate image →  button

After shooting, you can change the orientation in which still images are displayed. Still images can be rotated 90 degrees clockwise or 90 degrees counterclockwise.

When you select an image you want to rotate in the image selection screen (36), the Rotate image screen is displayed. You can then rotate the image 90 degrees by pressing the multi selector  or .



Rotate 90 degrees
counterclockwise



Rotate 90 degrees
clockwise





When you press the  button, the displayed orientation is applied, and the orientation information is saved with the image.

Notes About Image Rotation

This camera cannot rotate images captured with another make or model of digital camera.

Copy (Copy Between Internal Memory and Memory Card)

Press the  button (playback mode) → MENU button → Copy →  button

You can copy images between the internal memory and a memory card.

1 Use the multi selector to select a destination option to which images are copied and then press the  button.

- **Camera to card:** Copies images from internal memory to memory card.
- **Card to camera:** Copies images from memory card to internal memory.

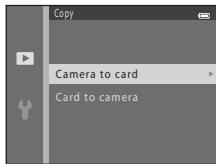

2 Select a copy option and then press the  button.

- **Selected images:** Copies images selected from the image selection screen (36).
- **All images:** Copies all images.

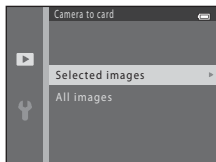

Notes About Copying Images

- JPEG- and AVI-format files can be copied.
- Operation is not guaranteed with images captured with another make of camera or that have been modified on a computer.
- When copying images for which **Print order** (0631) options are enabled, the print order settings are not copied. However, when copying images for which **Protect** (0635) is enabled, the protect setting is copied.

If “Memory contains no images.” Is Displayed

If a memory card that contains no images is inserted into the camera, **Memory contains no images.** is displayed when the camera is switched to playback mode. Press the **MENU** button to display the copy options screen, and copy the images saved in the camera's internal memory to the memory card.

More Information

File and Folder Names → 0665



The Movie Menu

Movie Options

Enter shooting mode → MENU button →  menu icon → Movie options →  button

You can select the desired movie option for recording movies.

Larger image sizes produce greater image quality and larger file sizes.

Option	Image size (pixels) Aspect ratio
 720/30p (default setting*)	1280 × 720 16:9
 480/30p	640 × 480 4:3
 240/30p	320 × 240 4:3

* When no memory card is inserted (i.e., when using the camera's internal memory), the setting is

 **480/30p.**

- The frame rate is approx. 30 fps no matter which option is selected.





Notes About Frame Rates

Frame rates describe the number of frames captured each second.

Maximum Movie Recording Time

The following table lists the approximate recording time available when using a 4 GB memory card. Actual recording time and file size may vary depending on subject movement and image composition, even when memory capacity and movie settings remain constant.

Available recording time may also vary depending on the type of memory card being used.

Movie options ¹	Maximum recording time (4 GB) ²
 720/30p	15 min
 480/30p	50 min
 240/30p	2 h 40 min

¹ When using the internal memory,  **720/30p** cannot be selected.

² The maximum size for a single movie is 2 GB, and the maximum recording time for a single movie is 29 minutes, even when there is sufficient free space on the memory card. When recording a movie, the remaining recording time that is displayed is the amount of recording time available for one movie. If the camera becomes hot, movie recording may stop before these limits are reached.

- To confirm the maximum length of a movie that can be recorded in the internal memory (approx. 25 MB), remove the memory card from the camera, and then check the maximum recording time displayed in the monitor when shooting.

More Information

File and Folder Names →  65

Autofocus Mode



Enter shooting mode → MENU button →  menu icon → Autofocus mode →  button

You can select how the camera focuses in movie mode.







Option	Description
AF-S Single AF (default setting)	Focus is locked when the ● () button is pressed to start recording. Select this option when the distance between the camera and the subject remains fairly consistent.
AF-F Full-time AF	Camera focuses continuously. Select this option when the distance between the camera and subject changes significantly during recording. The sound of the camera focusing may be heard in the recorded movie. Use of Single AF is recommended to prevent the sound of the camera focusing from interfering with recording.

The Setup Menu

Welcome Screen

MENU button →  menu icon → Welcome screen →  button









You can configure the welcome screen that is displayed when you turn on the camera.

Option	Description
None (default setting)	The camera enters shooting or playback mode without displaying the welcome screen.
COOLPIX	The camera displays a welcome screen and enters shooting or playback mode.
Select an image	<p>Displays an image selected for the welcome screen. When the image selection screen is displayed, select an image () and then press the  button.</p> <ul style="list-style-type: none">As the selected image is saved by the camera, it is displayed when the camera is turned on even if the original image is deleted.Images captured at an Image mode () setting of  5120x2880 and images created by using small picture () or crop () that are 320 x 240 or smaller, cannot be selected.

Time Zone and Date

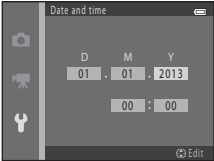
MENU button →  menu icon → Time zone and date →  button

You can set the camera clock.

Option	Description
Date and time	<p>Allows you to set the camera's clock to the current date and time. Use the multi selector to set each item displayed on the screen.</p> <ul style="list-style-type: none">• Select an item: Press  or  (changes between D, M, Y, hour, minute).• Edit the highlighted item: Press  or .• Apply the setting: Select the minute setting and then press the . 
Date format	The available date formats are Year/Month/Day , Month/Day/Year , and Day/Month/Year .
Time zone	Home time zone () can be specified and daylight saving time can be enabled or disabled. When the travel destination () is selected, the time difference between the travel destination and the home time zone () is automatically calculated and the date and time in the selected region are used when the camera records the shooting date and time. This can be useful when traveling.

Selecting the Travel Destination Time Zone

- 1 Use the multi selector to select **Time zone** and then press the **OK** button.

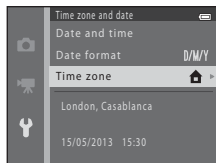

- 2 Select **Travel destination** and then press the **OK** button.

- The date and time displayed in the monitor changes according to the region currently selected.

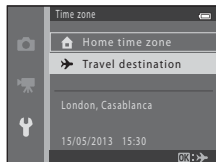

- 3 Press **▶**.

- The travel destination screen is displayed.

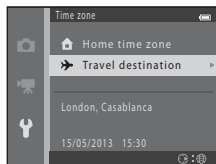

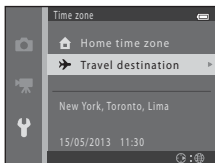
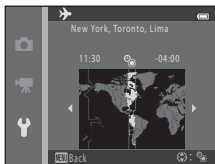

4 Press ◀ or ▶ to select the travel destination time zone.

- If daylight saving time is in effect, press ▲ to enable daylight saving time function. ☀ is displayed in the monitor and the camera clock is advanced one hour. Press ▼ to disable the daylight saving time function.
- Press the OK button to apply the travel destination time zone.
- For other time zones, set the camera clock to local time using the **Date and time** setting.
- While the travel destination time zone is selected, ⤴ is displayed in the monitor when the camera is in shooting mode.



Home Time Zone

- To switch to the home time zone, select  **Home time zone** in step 2, and then press the OK button.
- To change the home time zone, select  **Home time zone** in step 2, and then complete steps 3 and 4.



Daylight Saving Time

When daylight saving time starts or ends, turn the daylight saving time function on or off from the time zone selection screen displayed in step 4.

Imprinting Date on Images

Enable date imprint from the **Print date** option (49) in the setup menu after the date and time have been set. When the **Print date** option is enabled, images are saved with shooting date imprinted on them.

Monitor Settings



MENU button →  menu icon → Monitor settings →  button

You can set the options below.

Option	Description
Photo info	Select information displayed in the monitor during shooting and playback.
Brightness	Select from five settings for monitor brightness. The default setting is 3 .

Photo Info

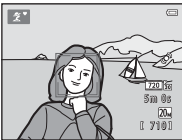
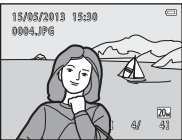
You can select whether or not the photo information is displayed in the monitor.

	Shooting mode	Playback mode
Show info		
Auto info (default setting)	The same information as in Show info is displayed. If no operations are performed after a few seconds, the display is the same as Hide info . The information is displayed again when an operation is performed.	
Hide info		

Shooting mode

Playback mode

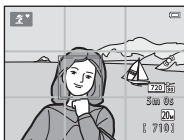
Framing
grid+auto info

In addition to information shown with **Auto info**, a framing grid is displayed to help frame pictures. The framing grid is not displayed when recording movies.

The same information as in **Auto info** is displayed.

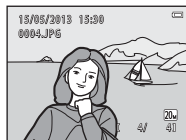
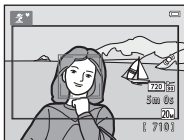
Movie
frame+auto info



In addition to information shown with **Auto info**, a frame is displayed before recording begins that represents the area that is captured when recording movies. The movie frame is not displayed when recording movies.

The same information as in **Auto info** is displayed.

 **Battery Level**



When the battery level is low,  is always displayed regardless of the **Photo info** setting.

Print Date (Imprinting Date and Time)

MENU button →  menu icon → Print date →  button





The shooting date and time can be imprinted on the images when shooting, allowing the information to be printed even from printers that do not support date printing (33).



Option	Description
 DATE Date	Date is imprinted on images.
 DATE Date and time	Date and time are imprinted on images.
OFF Off (default setting)	Date and time are not imprinted on images.

The icon for the current setting is displayed in the monitor when the camera is in shooting mode (6). No icon is displayed when **Off** is selected.



Notes About Print Date

- Imprinted dates form a permanent part of image data and cannot be deleted. The date and time cannot be imprinted on images after they have been captured.
- The date cannot be imprinted in the following situations:
 - When using **Panorama assist** in scene mode or when **Pet portrait** is set to **Continuous**
 - When recording movies
- Dates imprinted at an **Image mode** setting (22) of **VGA 640×480** may be difficult to read. Select an **Image mode** setting of  **1600×1200** or larger when using print date.
- The date is saved using the format selected in the setup menu's **Time zone and date** option (14, 44).



Print Date and Print Order



When printing with a DPOF-compatible printer that can print the shooting date and shooting information, you can use the **Print order** option (31) to print this information in images, even if the **Print date** function was set to **Off** at the time of shooting.

Electronic VR

MENU button →  menu icon → Electronic VR →  button

You can select the electronic VR (vibration reduction) setting used when shooting still images.



Option	Description
 Auto	The effects of camera shake are reduced when shooting still images in the following situations: <ul style="list-style-type: none">• When the flash mode is set to  (off) or  SLOW (slow sync)• When the shutter speed is slow• When the Continuous setting is set to Single• When the subject is dark
OFF Off (default setting)	Electronic VR is disabled.

When **Auto** is selected, electronic VR is applied according to the shooting conditions while  is displayed in the shooting screen ( 6).



Notes About Electronic Vibration Reduction

- Electronic VR is disabled while the flash is used, except when using slow sync mode. Note that Electronic VR is disabled even when flash mode is slow sync with red-eye reduction (📖 53).
- If the exposure period exceeds a certain period of time, electronic VR will not function.
- Electronic VR cannot be used if **Blink proof** (👁️ 30) in smart portrait mode is set to **On**.
- Electronic VR cannot be used when using the following scene modes.
 - Sports (📖 34)
 - Night portrait (📖 35)
 - Dusk/dawn (📖 35)
 - Night landscape (📖 35)
 - Museum (📖 36)
 - Fireworks show (📖 37)
 - Backlighting (📖 37)
 - When **Pet portrait** (📖 38) is set to **Continuous**
- The effectiveness of electronic VR decreases as camera shake increases.
- The images captured may become somewhat grainy.

Motion Detection

MENU button →  menu icon → Motion detection →  button

You can select the motion detection setting—which reduces the effects of subject movement and camera shake—used when shooting still images.

Option	Description
 Auto (default setting)	<p>When the camera detects subject movement or camera shake, the ISO sensitivity and shutter speed are automatically increased to reduce blurring. However, motion detection does not function in the following situations:</p> <ul style="list-style-type: none">• When the flash fires• In the following scene modes: Sports (📖 34), Night portrait (📖 35), Dusk/dawn (📖 35), Night landscape (📖 35), Museum (📖 36), Fireworks show (📖 37), Backlighting (📖 37), and Pet portrait (📖 38)• In  (auto) mode, when Continuous is set to Multi-shot 16 ( 27)
OFF Off	Motion detection is disabled.

The icon for the current setting is displayed in the monitor when the camera is in shooting mode (📖 6).

When the camera detects camera shake or subject movement, it increases shutter speed and the motion detection icon turns green. No icon is displayed when **Off** is selected.



Notes About Motion Detection

- Motion detection may be unable to completely eliminate the effects of subject movement and camera shake in some situations.
- Motion detection may not function if the subject exhibits significant movement or is too dark.
- The images captured using motion detection may be somewhat “grainy” in appearance.



AF Assist

MENU button →  menu icon → AF assist →  button



You can enable or disable the AF-assist illuminator, which assists autofocus operation when the subject is dimly lit.

Option	Description
Auto (default setting)	The AF-assist illuminator lights automatically when the subject is dimly lit. The illuminator has a range of about 1.9 m (6 ft 2 in.) at the maximum wide-angle position and about 1.1 m (3 ft 7 in.) at the maximum telephoto position. Note that for some scene modes (such as Museum  36) and Pet portrait  38), the AF-assist illuminator may not light even when Auto is selected.
Off	The AF-assist illuminator does not light. The camera may be unable to focus under dim lighting.

Sound Settings

MENU button →  menu icon → Sound settings →  button

You can adjust the following sound settings.

Option	Description
Button sound	Select On (default setting) or Off . When On is selected, a beep sounds once when operations are completed successfully, two times when the focus has been locked, and three times when an error is detected, and the welcome sound is played when the camera is turned on.
Shutter sound	Select On (default setting) or Off . Even when set to On , the shutter sound is not heard in the following situations: <ul style="list-style-type: none">• When using Continuous, BSS, or Multi-shot 16 ( 27)• When using Sports ( 34) or Museum ( 36) in scene mode• When recording movies

Notes About Sound Settings

Button sounds and the shutter sound are not heard when using the **Pet portrait** scene mode.

Auto Off



MENU button →  menu icon → Auto off →  button

If no operations are performed for a specified amount of time, the monitor turns off and the camera enters standby mode to save power ( 19).

This setting determines the amount of time that passes before the camera enters standby mode.

Option	Description
Auto off	You can select 30 s (default setting), 1 min , 5 min , or 30 min .
Sleep mode	If On (default setting) is selected, the camera enters standby mode when there is no change in the brightness of the subject, even before the time selected in the auto off menu has elapsed. The camera enters sleep mode after 30 seconds when Auto off is set to 1 min or less, or after one minute when Auto off is set to 5 min or more.



When the Monitor Has Turned Off to Save Power

- When the camera is in standby mode, the power-on lamp flashes.
- If no operations are performed for approx. another three minutes, the camera turns off automatically.
- When the power-on lamp is flashing, pressing any of the following buttons turns the monitor back on:
 - Power switch, shutter-release button,  button,  button, or  (▶) movie-record) button

The Auto Off Setting

- The time that passes before the camera enters standby mode is fixed in the following situations:
 - When a menu is displayed: Three minutes (when auto off is set to **30 s** or **1 min**)
 - During slide show playback: Up to 30 minutes
 - When the audio/video cable is connected: 30 minutes
- The camera does not enter standby mode while the Eye-Fi card is uploading images.

Format Memory/Format Card

MENU button →  menu icon → Format memory/Format card →  button

Use this option to format the internal memory or a memory card.

Formatting the internal memory or memory cards permanently deletes all data. Data that has been deleted cannot be recovered. Be sure to transfer important data to a computer before formatting.

Formatting the Internal Memory

To format the internal memory, remove the memory card from the camera. The **Format memory** option is displayed in the setup menu.

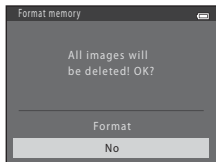

Formatting Memory Cards

When a memory card is inserted in the camera, the **Format card** option is displayed in the setup menu.

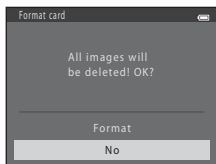

Notes About Formatting Internal Memory and Memory Cards

- Do not turn the camera off or open the battery-chamber/memory card slot cover during formatting.
- The first time you insert a memory card that has been used in another device into this camera, be sure to format it with this camera.

Language



MENU button →  menu icon → Language →  button

You can select one of 34 languages for display of camera menus and messages.

Čeština	Czech
Dansk	Danish
Deutsch	German
English	(Default setting)
Español	Spanish
Ελληνικά	Greek
Français	French
Indonesia	Indonesian
Italiano	Italian
Magyar	Hungarian
Nederlands	Dutch
Norsk	Norwegian
Polski	Polish
Português (BR)	Brazilian Portuguese
Português (PT)	European Portuguese
Русский	Russian
Română	Romanian

Suomi	Finnish
Svenska	Swedish
Tiếng Việt	Vietnamese
Türkçe	Turkish
Українська	Ukrainian
عربي	Arabic
বাংলা	Bengali
简体中文	Simplified Chinese
繁體中文	Traditional Chinese
हिन्दी	Hindi
日本語	Japanese
한국	Korean
मराठी	Marathi
فارسی	Persian
தமிழ்	Tamil
తెలుగు	Telugu
ภาษาไทย	Thai



Video Mode

MENU button →  menu icon → Video mode →  button

You can adjust settings for connection to a TV.

Set the camera's analog video output signal to **NTSC** or **PAL** according to the specification of your TV.

Blink Warning

MENU button →  menu icon → Blink warning →  button

You can select whether or not the camera detects human subjects that have blinked using face detection ( 57) when shooting in the following modes:

-  (easy auto) mode
- **Portrait** ( 34) or **Night portrait** ( 35) scene mode





Option	Description
On	When the camera detects that one or more human subjects may have blinked in an image captured using face detection, the Did someone blink? screen is displayed in the monitor. The face of the human subject that may have blinked when the shutter was released is framed by a yellow border. Should this occur, check the image and determine whether or not another image should be captured ( 59).
Off (default setting)	Blink warning is disabled.

The Blink Warning Screen



When the **Did someone blink?** screen shown on the right is displayed in the monitor, the operations described below are available.

If no operations are performed within a few seconds, the camera automatically returns to shooting mode.





Function	Description
Enlarge the detected face that blinked	Rotate the zoom control to T (Q).
Switch to full-frame playback mode	Rotate the zoom control to W (R).
Select the face to be displayed	While zoomed in, press the multi selector ◀ or ▶ to switch to another face.
Delete the image	Press the  button.
Switch to shooting mode	Press the  button, shutter-release button,  button, or the  button.

Eye-Fi Upload

MENU button →  menu icon → Eye-Fi upload →  button

You can select whether or not the camera's Eye-Fi card (available from third-party manufacturers) sends images to your computer.





Option	Description
 Enable	Images created with this camera are uploaded to the pre-determined computer.
 Disable (default setting)	Images are not uploaded.

Notes About Eye-Fi Cards

- Note that images are not uploaded if signal strength is insufficient even if **Enable** is selected.
- When using the camera in an area where wireless signal output is not permitted, set this feature to **Disable**.
- Refer to the instruction manual of your Eye-Fi card for more information. In the event of malfunction or if you have any questions, contact the card manufacturer.
- The camera can be used to turn Eye-Fi cards on and off, but may not support all Eye-Fi functions.
- The camera is not compatible with the Endless Memory function. When it is set on a computer, disable the function. If the Endless Memory function is enabled, the number of pictures taken may not be displayed correctly.
- The Eye-Fi upload feature is intended for use only in the country of purchase. Before using it in other countries, refer to laws and regulations of that country.
- When this setting is set to **Enable**, batteries are drained faster than normal.

Eye-Fi Upload Indicator

The upload status of the Eye-Fi card in the camera can be confirmed on the monitor ( 6, 8).





- : **Eye-Fi upload** is set to **Disable**.
-  (lights): Eye-Fi upload enabled; waiting for image upload.
-  (flashes): Eye-Fi upload enabled; uploading images.
- : Eye-Fi upload enabled but no images available for upload.
- : An error occurred. The camera cannot control the Eye-Fi card.

Reset All





MENU button →  menu icon → Reset all →  button

When **Reset** is selected, the camera's settings are restored to their default values.



Basic Shooting Functions

Option	Default value
Flash mode ( 44)	Auto
Self-timer ( 47)	Off
Macro mode ( 49)	Off
Exposure compensation ( 51)	0.0

Scene Mode

Option	Default value
Scene mode setting in the shooting-mode selection menu ( 33)	Portrait
Hue adjustment in food ( 36)	Center
Continuous shooting in pet portrait ( 38)	Continuous
Pet portrait auto release in pet portrait ( 38)	On

Smart Portrait Menu

Option	Default value
Skin softening ( 29)	On
Smile timer ( 30)	On
Blink proof ( 30)	Off

Shooting Menu

Option	Default value
Image mode (0022)	20M 5152x3864
White balance (0024)	Auto
Continuous (0027)	Single
Color options (0028)	Standard color

Movie Menu

Option	Default value
Movie options (0040)	When a memory card is inserted: 720/30p
Autofocus mode (0042)	Single AF

Setup Menu



Option	Default value
Welcome screen (0043)	None
Photo info (0047)	Auto info
Brightness (0047)	3
Print date (0049)	Off
Electronic VR (0050)	Off
Motion detection (0052)	Auto
AF assist (0053)	Auto
Button sound (0054)	On
Shutter sound (0054)	On
Auto off (0055)	30 s
Sleep mode (0055)	On
Blink warning (0058)	Off
Eye-Fi upload (0060)	Disable

Others

Option	Default value
Paper size (Fn18, Fn19)	Default
Loop setting for slide shows (Fn34)	Off

- Selecting **Reset all** also resets the camera's file numbering (Fn65). After a reset, the camera determines the largest file number in the internal memory or on the memory card and saves images using the next available file number. To reset file numbering to "0001", delete all images saved in the internal memory or on the memory card (p. 28) before selecting **Reset all**.
- The following menu settings remain unaffected when menus are reset with **Reset all**.
 - Shooting menu: Preset manual data (Fn25) acquired for **White balance**
 - Setup menu: Settings for image registered for **Welcome screen** (Fn43), **Time zone and date** (Fn44), **Language** (Fn57), **Video mode** (Fn58), and **Battery type** (Fn64)

Battery Type

MENU button →  menu icon → Battery type →  button

To ensure that the camera shows the correct battery level ( 18), select the type that matches the batteries currently in use.

Option	Description
Alkaline (default setting)	LR6/L40 (AA-size) alkaline batteries
COOLPIX (Ni-MH)	Nikon EN-MH2 rechargeable Ni-MH (nickel metal hydride) batteries
Lithium	FR6/L91 (AA-size) lithium batteries

Firmware Version

MENU button →  menu icon → Firmware version →  button

You can view the current camera firmware version.



File and Folder Names

Images and movies are assigned file names as follows.

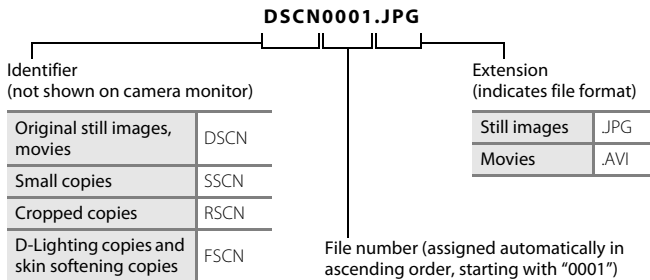



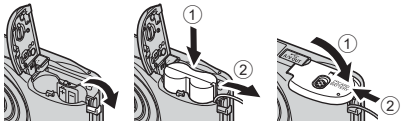

- Files are saved in folders named with a folder number followed by "NIKON" (e.g. "100NIKON"). A single folder can hold up to 200 images; if the current folder already contains 200 images, a new folder, named by adding one to the current folder name, is created the next time an image is captured (e.g. "100NIKON" → "101NIKON"). When the number of files within a folder reaches 9999, a new folder is created. File numbers are assigned automatically starting with 0001.
- In Panorama assist (📷2), a folder is created for each shooting session using the following naming convention: "Folder number + P_XXX" (e.g. "101P_001"). Images are saved in sequence in file numbers starting with 0001.
- Files copied using **Copy** > **Selected images** are copied to the current folder, where they are assigned new file numbers in ascending order starting from the largest file number in memory. **Copy** > **All images** copies all folders from the source medium; file names do not change but new folder numbers are assigned in ascending order, starting from the largest folder number on the destination medium (📷38).
- If the current folder is numbered 999 and contains 200 images, or an image is numbered 9999, no further images can be captured until the internal memory or memory card is formatted (📷56), or a new memory card is inserted.









Optional Accessories







Rechargeable battery	Rechargeable Ni-MH batteries EN-MH2-B2 (set of two EN-MH2 batteries)* Rechargeable Ni-MH batteries EN-MH2-B4 (set of four EN-MH2 batteries)*
Battery charger	Battery Charger MH-72 (includes two rechargeable Ni-MH batteries EN-MH2)* Battery Charger MH-73 (includes four rechargeable Ni-MH batteries EN-MH2)*
AC adapter	AC Adapter EH-65A (connect as shown)  AC Adapter EH-62B cannot be used.
Audio/video cable	Audio Video Cable EG-CP14









* To charge EN-MH2 batteries, use only Battery Charger MH-72 or MH-73. Do not use these battery chargers to charge any other type of battery.

Error Messages

Display	Cause/Solution	
 (flashes)	Clock not set. Set date and time.	 44
Battery exhausted.	Replace the batteries.	10
 (flashes in red)	Camera cannot focus. <ul style="list-style-type: none"> • Refocus. • Use focus lock. 	24, 60 59
Please wait for the camera to finish recording.	Wait until the image is saved and the message disappears from the display.	–
Memory card is write protected.	Write-protect switch is in “lock” position. Slide write-protect switch to “write” position.	–
Not available if Eye-Fi card is locked.	Eye-Fi card write-protect switch is in “lock” position. Slide write-protect switch to “write” position.	–
	Error accessing Eye-Fi card. <ul style="list-style-type: none"> • Check that terminals are clean. • Confirm that the card is correctly inserted. 	12 12
This card cannot be used.	Error accessing memory card. <ul style="list-style-type: none"> • Use approved card. • Check that terminals are clean. • Confirm that the card is correctly inserted. 	 19 12 12
This card cannot be read.		

Display	Cause/Solution	
Card is not formatted. Format card? Yes No	Memory card has not been formatted for use in this camera. Formatting deletes all data saved on the memory card. Be sure to select No and make copies of any images which need to be kept before formatting the memory card. Select Yes and then press the  button to format the memory card.	 6
Out of memory.	Memory card is full. <ul style="list-style-type: none"> • Change the image mode setting. • Delete images. • Insert new memory card. • Remove memory card and use internal memory. 	 22 28, 79 12 13
Image cannot be saved.	Error occurred while saving image. Format internal memory or memory card.	 56
	Camera has run out of file numbers. Insert a new memory card or format internal memory or memory card.	 65
	Image cannot be used for welcome screen. The following images cannot be registered as welcome screen. <ul style="list-style-type: none"> • Images captured at an Image mode setting of  5120×2880 • Images reduced to 320 × 240 size or smaller with cropping or small picture editing 	 43
	Insufficient space to save a copy. Delete images from destination.	28
A blink was detected in the picture just taken.	One or more portrait subjects may have blinked when the picture was taken. Check the image in playback mode.	26,  30

Display	Cause/Solution	
Image cannot be modified.	Cannot edit selected image. <ul style="list-style-type: none"> • Select images that support editing function. • Movies cannot be edited. 	 6 –
Cannot record movie.	Time out error while saving movie on the memory card. Select memory card with faster write speed.	12
Memory contains no images.	No images in the internal memory or memory card. <ul style="list-style-type: none"> • Remove the memory card from the camera to play back images saved in the camera's internal memory. • To copy images from internal memory to memory card, press the MENU button. The copy screen is displayed and images in the internal memory can be copied to memory card. 	12  38
File contains no image data.	File not created with this camera. File cannot be viewed on this camera. View file using a computer or the device used to create or edit this file.	–
All images are hidden.	No images available for a slide show.	 34
This image cannot be deleted.	Image is protected. Disable protection.	 35
Travel destination is in the current time zone.	Home and travel destination are in the same time zone.	 45
Lens error	Lens error. Turn camera off and then on again. If error persists, contact retailer or Nikon-authorized service representative.	18
Communications error	Error occurred during communication with printer. Turn camera off and reconnect USB cable.	 15

Display	Cause/Solution	
System error	Error has occurred in camera's internal circuitry. Turn camera off, remove and reinsert batteries, and turn camera on. If error persists, contact retailer or Nikon-authorized service representative.	10, 19
Printer error: check printer status.	Printer error. Check printer. After solving the problem, select Resume and then press the  button to resume printing.*	–
Printer error: check paper	Specified size of paper is not loaded in printer. Load the specified size of paper, select Resume , and then press the  button to resume printing.*	–
Printer error: paper jam	Paper has jammed in printer. Remove the jammed paper, select Resume , and then press the  button to resume printing.*	–
Printer error: out of paper	No paper is loaded in printer. Load the specified size of paper, select Resume , and then press the  button to resume printing.*	–
Printer error: check ink	Ink error. Check ink, select Resume , and then press the  button to resume printing.*	–
Printer error: out of ink	Running out of ink or ink cartridge is empty. Replace ink cartridge, select Resume , and then press the  button to resume printing.*	–
Printer error: file corrupt	An error caused by the image file has occurred. Select Cancel and then press the  button to cancel printing.	–

* See the documentation provided with your printer for further guidance and information.



Technical Notes and Index

Caring for the Product	2
The Camera.....	2
Batteries.....	4
Memory Cards.....	6
Cleaning and Storage	7
Cleaning.....	7
Storage.....	7
Troubleshooting	8
Specifications	15
Approved Memory Cards.....	19
Supported Standards.....	19
Index	21

Caring for the Product

The Camera

To ensure safe and continued enjoyment of your Nikon camera, observe the following precautions and the precautions noted in "For Your Safety" (📖 x - xv) when using or storing your camera.

✔ **Do Not Subject the Product to Strong Shocks**

The product may malfunction if dropped or struck. Additionally, do not touch or apply force to the lens or lens cover.

✔ **Keep Dry**

If water enters the camera, internal components may rust or otherwise become damaged, and repairing the camera may be expensive or even impossible.

✔ **Avoid Sudden Changes in Temperature**

Sudden changes in temperature, such as when entering or leaving a heated building on a cold day, can cause condensation to form inside the device. To prevent condensation, place the device in a carrying case or a plastic bag before exposing it to sudden changes in temperature.

✔ **Keep away from Strong Magnetic Fields**

Do not use or store this device in the vicinity of equipment that generates strong electromagnetic radiation or magnetic fields. Strong static charge or the magnetic fields produced by equipment such as radio transmitters could interfere with the monitor, damage data saved on the memory card, or affect the product's internal circuitry.

✔ **Do Not Point the Lens at Strong Light Sources for Extended Periods**

Avoid pointing the lens at the sun or other strong light sources for extended periods when using or storing the camera. Intense light may damage the image sensor or other components, producing a white blur effect in photographs.

Turn the Camera off Before Removing the Batteries, AC Adapter, or Memory Card

Removing the batteries, AC adapter, or memory card while the camera is on could damage the camera or memory card. If removed while the camera is saving or deleting data, data may be lost and the camera's memory or the memory card may be damaged.

Notes on the Monitor

- Monitors and electronic viewfinders are constructed with extremely high precision; at least 99.99% of pixels are effective, with no more than 0.01% being missing or defective. Hence while these displays may contain pixels that are always lit (white, red, blue, or green) or always off (black), this is not a malfunction and has no effect on images recorded with the device.
- Scraping or pressing on the surface of the monitor may result in damage or malfunction. Should the monitor break, care should be taken to avoid injury caused by broken glass and to prevent the liquid crystal from the display touching the skin or entering the eyes or mouth.
- Images in the monitor may be difficult to see under bright lighting.
- The monitor is lit by an LED backlight. Should the monitor begin to dim or flicker, contact your Nikon-authorized service representative.

Notes About Smear

White or colored streaks may be visible when bright subjects are framed in the monitor. This phenomenon, known as "smear," occurs when extremely bright light strikes the image sensor; it is characteristic of image sensors and does not indicate a malfunction. Smear may also take the form of partial discoloration in the monitor during shooting. It does not appear in images saved with the camera except in the cases of movies and of images saved with **Multi-shot 16** selected for **Continuous**. When shooting in these modes, we recommend that you avoid bright subjects such as the sun, reflected sunlight, and electric lights.

Batteries

Be sure to read and follow the warnings noted in “For Your Safety” (📖 x-xv) before use.

✔ Notes About Using Batteries

- Used batteries may overheat. Handle with caution.
- Do not use batteries beyond their recommended expiration date.
- Do not turn the camera on and off repeatedly if discharged batteries are inserted in the camera.

✔ Spare Batteries

We recommend carrying spare batteries depending on where you are shooting. It may be difficult to purchase batteries in certain areas.

✔ Charging Batteries

If using optional rechargeable batteries, charge the batteries before taking pictures. Batteries are not charged at the time of purchase.

Be sure to read and follow the warnings noted in the operating instructions included with the battery charger.

✔ Charging Rechargeable Batteries

- Do not mix batteries with different amounts of charge remaining, or batteries of a different make or model.
- When using EN-MH2 batteries with the COOLPIX L28, charge two batteries at a time using Battery Charger MH-72. When using Battery Charger MH-73, charge the batteries two or four at a time. Use only Battery Charger MH-72 or MH-73 to charge EN-MH2 batteries.
- When using Battery Charger MH-72 or MH-73, only charge EN-MH2 batteries.

✔ Notes About EN-MH1 Rechargeable Batteries and Battery Charger MH-70/71

- You can also use EN-MH1 Ni-MH rechargeable batteries with this camera.
- Use only Battery Charger MH-70 or MH-71 to charge EN-MH1 batteries.
- When using Battery Charger MH-70 or MH-71, only charge EN-MH1 batteries.
- Set the **Battery type** setting (📖 83, ⚙️ 64) to **COOLPIX (Ni-MH)**.

Notes About Rechargeable Ni-MH Batteries

- If you repeatedly charge rechargeable Ni-MH batteries while they still have some charge remaining, the message **Battery exhausted.** may be displayed prematurely when using the batteries. This is due to the “memory effect,” in which the amount of charge the batteries can hold decreases temporarily. Use the batteries until there is no charge remaining and they will return to their normal behavior.
- Rechargeable Ni-MH batteries discharge even when not being used. We recommend charging the batteries just before using them.

Cold Environment Usage

Battery performance decreases in cold environments. When using the camera in cold environments, try not to let the camera and batteries become too cold. The camera may not function if you use discharged batteries in cold environments. Keep spare batteries warm and alternate between two sets of batteries. Batteries that cannot be used because they have become too cold can often be used again when they have been warmed up.

Battery Terminals

Dirt on the battery terminals can prevent the camera from functioning. Remove dirt from the terminals using a dry cloth.



Remaining Battery Charge

If you insert discharged batteries into the camera, the camera may indicate that the batteries have adequate charge remaining. This is a characteristic of batteries.

Recycling

Used batteries are a valuable resource. Please recycle used batteries in accordance with local regulations. Cover the battery terminals with plastic tape when recycling.

Memory Cards

- Use only Secure Digital memory cards. Approved memory cards → :19
- Observe the precautions noted in the documentation included with your memory card.
- Do not affix labels or stickers to the memory card.
- Do not format the memory card using a computer.
- Before using a memory card with this camera, format the card using this camera if the card has been used with another device. Before using a new memory card, we recommend using this camera to format the card.
- Note that **formatting a memory card permanently deletes all images and other data on the memory card**. If there is data saved on the memory card that you wish to keep, copy that data to a computer before formatting.
- If the message **Card is not formatted. Format card?** is displayed when you insert a memory card, the memory card must be formatted. If there is data on the memory card that you do not want to delete, select **No**. Copy that data to a computer before formatting. To format the memory card, select **Yes** and then press the  button.
- Observe the following precautions while formatting the memory card, saving and deleting images, and copying images to a computer, otherwise data or the memory card itself may be damaged.
 - Do not open the battery-chamber/memory card slot cover or remove the memory card or batteries.
 - Do not turn off the camera
 - Do not disconnect the AC adapter

Cleaning and Storage

Cleaning

Do not use alcohol, thinner, or other volatile chemicals.

Lens	When cleaning the lens, avoid touching it directly with your fingers. Remove dust or lint with a blower. To remove fingerprints, oil, or other grime that cannot be removed with a blower, wipe the lens with a soft, dry cloth or an eyeglass cleaning cloth, using a gentle spiral motion that starts in the center and moves toward the edges. Do not wipe forcefully or wipe with a rough cloth, otherwise the camera may be damaged or malfunction. If you still cannot remove the grime, wet a soft cloth with a commercial liquid lens cleaner and gently wipe off the grime.
Monitor	Remove dust or lint with a blower. To remove fingerprints, oil, or other grime, wipe the area with a soft, dry cloth or an eyeglass cleaning cloth. Do not wipe forcefully or wipe with a rough cloth, otherwise the camera may be damaged or malfunction.
Body	<ul style="list-style-type: none">Remove dust or lint with a blower. Wipe with a soft, dry cloth.After using the camera at the beach or other sandy or dusty environment, wipe off any sand, dust, or salt with a dry cloth lightly dampened with fresh water and dry thoroughly. <p>Note that foreign matter inside the camera could cause damage not covered by the warranty.</p>

Storage









Remove the batteries if the camera will not be used for an extended period. To prevent mold or malfunction and to ensure long, trouble-free use of the camera, we recommend you insert the batteries and operate the camera approx. once a month. Do not store the camera with naphtha or camphor moth balls, or in any of the following locations:









- Next to equipment that produces strong electromagnetic fields, such as televisions or radios
- Places that are exposed to temperatures below -10°C (14°F) or above 50°C (122°F)
- Places that are poorly ventilated or subject to humidity of over 60%

Troubleshooting











If the camera fails to function as expected, check the list of common problems below before consulting your retailer or Nikon-authorized service representative.









Power, Display, Settings Issues







Problem	Cause/Solution	
The camera is on but does not respond.	<ul style="list-style-type: none">• Wait for recording to end.• If the problem persists, turn the camera off. If the camera does not turn off, remove and reinsert the battery or batteries or, if you are using an AC adapter, disconnect and reconnect the AC adapter. Note that although any data currently being recorded will be lost, data that have already been recorded will not be affected by removing or disconnecting the power source.	– 10, 11, 19,  66
Camera turns off without warning.	<ul style="list-style-type: none">• Batteries are exhausted.• Camera has turned off automatically to save power.• The camera and batteries have become too cold and cannot operate properly.	18 82,  55  5
Monitor is blank.	<ul style="list-style-type: none">• Camera is off.• Batteries are exhausted.• Standby mode for saving power: Press the power switch, the shutter-release button,  button,  button, or  button.• When flash lamp flashes, wait until flash has charged.• Camera and computer are connected via USB cable.• Camera and TV are connected via audio/video cable.	19 18 2, 19 46 65, 70 65,  12

Problem	Cause/Solution	
Monitor is hard to read.	<ul style="list-style-type: none"> Adjust monitor brightness. Monitor is dirty. Clean monitor. 	82,  47  7
Date and time of recording are not correct.	<ul style="list-style-type: none"> If camera clock has not been set,  flashes when shooting images and recording movies. Images and movies saved before clock is set are dated “00/00/0000 00:00” or “01/01/2013 00:00” respectively. Set the correct time and date using Time zone and date in the setup menu. Check camera clock regularly against more accurate timepieces and reset as required. 	14, 82,  44
No indicators displayed in monitor.	Hide info is selected for Photo info . Select Show info .	82,  47
Print date not available.	Time zone and date in the setup menu has not been set.	14, 82,  44
Date not imprinted on images even when Print date is enabled.	<ul style="list-style-type: none"> The current shooting mode is one that does not support Print date. The date cannot be imprinted on movies. 	82,  49
Screen for setting time zone and date is displayed when camera is turned on.	Clock battery is exhausted; all settings were restored to their default values.	14, 17
Camera settings reset.		
Camera becomes hot.	The camera may become hot when recording movies or uploading images from an Eye-Fi card for an extended period of time, or when the camera is used in a hot area; this is not a malfunction.	–







Shooting Issues



Problem	Cause/Solution	
Cannot switch to shooting mode.	Disconnect USB cable.	65, 70,  15
No image captured when the shutter-release button is pressed.	<ul style="list-style-type: none"> • When camera is in playback mode, press the  button, the shutter-release button, or the  ( movie-record) button. • When menus are displayed, press the MENU button. • Batteries are exhausted. • When flash lamp flashes, flash is charging. 	26 3 18 46
Camera cannot focus.	<ul style="list-style-type: none"> • Subject is too close. Try shooting using easy auto mode, Close-up scene mode, or macro mode. • The intended subject is one with which autofocus does not perform well. • Set AF assist in the setup menu to Auto. • Turn camera off and then on again. 	32, 36, 49 60 82,  53 19
Images are blurred.	<ul style="list-style-type: none"> • Use flash. • Enable electronic VR or motion detection. • Use BSS (best shot selector). • Use tripod and self-timer. 	44 82,  50,  52 36, 55,  27 47
Streaks of light or partial discoloration are visible in the monitor.	Smear occurs when extremely bright light strikes the image sensor. When shooting with Continuous set to Multi-shot 16 and when recording movies, avoiding bright objects, such as the sun, reflections of the sun, and electric lights is recommended.	55,  27,  3

Problem	Cause/Solution		
Bright specks appear in images captured with flash.	Flash is reflecting off particles in air. Set the flash mode setting to  (off).	45	
Flash does not fire.	<ul style="list-style-type: none"> • The flash mode is set to  (off). 	44	
	<ul style="list-style-type: none"> • Scene mode with which the flash does not fire is selected. 	52	
	<ul style="list-style-type: none"> • On is selected for Blink proof in smart portrait menu. 	55,  30	
	<ul style="list-style-type: none"> • Another function that restricts flash is enabled. 	56	
Digital zoom cannot be used.	<ul style="list-style-type: none"> • Digital zoom cannot be used in the following situations. 	34, 35, 38	
	<ul style="list-style-type: none"> - When Portrait, Night portrait, or Pet portrait is selected in scene mode 		39
	<ul style="list-style-type: none"> - When Continuous in the shooting menu is set to Multi-shot 16 		55,  27
Image mode not available.	Another function that restricts the Image mode option is enabled.	56	
No sound when shutter is released.	<ul style="list-style-type: none"> • Off is selected for Sound settings > Shutter sound in the setup menu. No sound is heard with some shooting modes and settings, even when On is selected. 	82,  54	
	<ul style="list-style-type: none"> • Do not block the speaker. 	3	
AF-assist illuminator does not light.	Off is selected for AF assist in the setup menu. AF-assist illuminator may not light depending on the current scene mode, even when Auto is selected.	82,  53	
Images appear smeared.	Lens is dirty. Clean lens.	 7	
Colors are unnatural.	White balance or hue is not adjusted properly.	36, 55,  24	

Problem	Cause/Solution	
Randomly spaced bright pixels (“noise”) appear in image.	The subject is dark, so shutter speed is too slow or ISO sensitivity is too high. Noise can be reduced by using flash.	44
Images are too dark (underexposed).	<ul style="list-style-type: none"> • The flash mode is set to  (off). • Flash is blocked by finger or other object. • Subject is beyond flash range. • Adjust exposure compensation. • Subject is backlit. Select Backlighting scene mode or set the flash mode setting to  (fill flash). 	44 22 46 51 37, 44
Images are too bright (overexposed).	Adjust exposure compensation.	51
Areas not affected by red-eye are corrected.	When taking pictures with  (auto with red-eye reduction) or fill flash with slow sync and red-eye reduction in Night portrait (either in easy auto mode or in scene mode), red-eye reduction may be applied to areas not affected by red-eye in rare cases. Use auto mode or any scene mode other than Night portrait , and change the flash mode to any setting other than  (auto with red-eye reduction) and try taking a picture again.	35, 44
Skin tones are not softened.	<ul style="list-style-type: none"> • In some shooting conditions, facial skin tones may not be smoothed. • Use Skin softening in the playback menu for images containing four or more faces. 	41 64, 
Saving images takes time.	It may take more time to save images in the following situations. <ul style="list-style-type: none"> • When the noise reduction function is in operation, such as when shooting in a dark environment • When the flash mode is set to  (auto with red-eye reduction) • When the skin softening function is applied while shooting 	– 46 34, 35, 55

Playback Issues

Problem	Cause/Solution	
File cannot be played back.	<ul style="list-style-type: none"> • File or folder was overwritten or renamed by computer or other make of camera. • This camera cannot play back movies recorded with another make or model of digital camera. 	<p>–</p> <p>79</p>
Cannot zoom in on image.	<ul style="list-style-type: none"> • Playback zoom cannot be used with movies, small pictures, or images that have been cropped to a size of 320 × 240 or smaller. • This camera may not be able to zoom in on images captured with another make or model of digital camera. 	<p>–</p>
Cannot use D-Lighting, skin softening, small picture, or crop.	<ul style="list-style-type: none"> • These options cannot be used with movies. • The same editing feature cannot be applied multiple times. • This camera cannot edit images captured with another make or model of digital camera. • Images captured when Image mode is set to  5120x2880 cannot be edited using the skin softening function. 	<p>–</p> <p>64, 6</p> <p>64, 6</p> <p>64, 8</p>
Cannot rotate image.	This camera cannot rotate images captured with another make or model of digital camera.	<p>–</p>
Images are not displayed on TV.	<ul style="list-style-type: none"> • Video mode in the setup menu is not correctly set. • Memory card contains no images. Replace the memory card. Remove the memory card to play back images from the internal memory. 	<p>83, 58</p> <p>12</p>
Nikon Transfer 2 does not start when camera is connected.	<ul style="list-style-type: none"> • Camera is off. • Batteries are exhausted. • USB cable is not correctly connected. • Camera is not recognized by the computer. • Confirm system requirements. • Computer is not set to start Nikon Transfer 2 automatically. For more information about Nikon Transfer 2, refer to help information contained in ViewNX 2. 	<p>19</p> <p>18</p> <p>65, 70</p> <p>–</p> <p>67</p> <p>70</p>

Problem	Cause/Solution	
Images to be printed are not displayed.	<ul style="list-style-type: none"> • Memory card contains no images. Replace the memory card. • Remove the memory card to print images from the internal memory. 	12
Cannot select paper size with camera.	<p>Paper size cannot be selected from the camera in the following situations, even when printing from a PictBridge-compatible printer. Use the printer to select paper size.</p> <ul style="list-style-type: none"> • The printer does not support the paper sizes specified by the camera. • The printer automatically selects the paper size. 	65,  18,  19 –

Specifications

Nikon COOLPIX L28 Digital Camera

Type	Compact digital camera
Number of effective pixels	20.1 million
Image sensor	$\frac{1}{2.3}$ -in. type CCD; approx. 20.48 million total pixels
Lens	NIKKOR lens with 5x optical zoom
Focal length	4.6–23.0 mm (angle of view equivalent to that of 26–130 mm lens in 35mm [135] format)
f/-number	f/3.2–6.5
Construction	6 elements in 5 groups
Digital zoom magnification	Up to 4x (angle of view equivalent to that of approx. 520 mm lens in 35mm [135] format)
Motion blur reduction	Electronic VR (still pictures), motion detection (still pictures)
Autofocus (AF)	Contrast-detect AF
Focus range	<ul style="list-style-type: none">• [W]: Approx. 50 cm (1 ft 8 in.)–∞, [T]: Approx. 80 cm (2 ft 8 in.)–∞• Macro mode: Approx. 10 cm (4 in.) (wide-angle position relative to –∞) (All distances measured from center of front surface of lens)
Focus-area selection	Center, face detection
Monitor	7.5 cm (3-in.), approx. 230k-dot, TFT LCD with anti-reflection coating and 5-level brightness adjustment
Frame coverage (shooting mode)	Approx. 98% horizontal and 98% vertical (compared to actual picture)
Frame coverage (playback mode)	Approx. 98% horizontal and 98% vertical (compared to actual picture)

Storage		
Media		Internal memory (approx. 25 MB), SD/SDHC/SDXC memory card
File system		DCF, Exif 2.3, and DPOF compliant
File formats		Still pictures: JPEG Movies: AVI (Motion-JPEG compliant)
Image size (pixels)		<ul style="list-style-type: none"> • 20M (High) [5152 × 3864 ★] • 20M [5152 × 3864] • 10M [3648 × 2736] • 4M [2272 × 1704] • 2M [1600 × 1200] • VGA [640 × 480] • 16:9 [5120 × 2880]
ISO sensitivity (Standard output sensitivity)		ISO 80–1600
Exposure		
Metering mode		Matrix, center-weighted (digital zoom less than 2×), spot (digital zoom 2× or more)
Exposure control		Programmed auto exposure and exposure compensation (–2.0 – +2.0 EV in steps of $\frac{1}{3}$ EV)
Shutter		Mechanical and charge-coupled electronic shutter
Speed		<ul style="list-style-type: none"> • $\frac{1}{2000}$–1 s • 4 s (Fireworks show scene mode)
Aperture		Electronically-controlled ND filter (–2.6 AV) selection
Range		2 steps (f/3.2 and f/8 [W])
Self-timer		Approx. 10 s
Built-in flash		
Range (ISO sensitivity: Auto)		[W]: Approx. 0.5–4.3 m (1 ft 8 in.–14 ft) [T]: Approx. 0.8–2.1 m (2 ft 8 in.–6 ft 10 in.)
Flash control		TTL auto flash with monitor preflashes

Interface	Hi-Speed USB
Data transfer protocol	MTP, PTP
Video output	Can be selected from NTSC and PAL
I/O terminal	Audio/video (A/V) output; digital I/O (USB)
Supported languages	Arabic, Bengali, Chinese (Simplified and Traditional), Czech, Danish, Dutch, English, Finnish, French, German, Greek, Hindi, Hungarian, Indonesian, Italian, Japanese, Korean, Marathi, Norwegian, Persian, Polish, Portuguese (European and Brazilian), Romanian, Russian, Spanish, Swedish, Tamil, Telugu, Thai, Turkish, Ukrainian, Vietnamese
Power sources	<ul style="list-style-type: none"> • Two LR6/L40 (AA-size) alkaline batteries • Two FR6/L91 (AA-size) lithium batteries • Two EN-MH2 rechargeable Ni-MH batteries (available separately) • AC Adapter EH-65A (available separately)
Battery life¹	
Still pictures	<ul style="list-style-type: none"> • Approx. 280 shots when using alkaline batteries • Approx. 890 shots when using lithium batteries • Approx. 530 shots when using EN-MH2 batteries
Movies (actual battery life for recording) ²	<ul style="list-style-type: none"> • Approx. 1 h 5 min when using alkaline batteries • Approx. 2 h 40 min when using lithium batteries • Approx. 1 h 30 min when using EN-MH2 batteries
Tripod socket	1/4 (ISO 1222)
Dimensions (W × H × D)	Approx. 95.4 × 59.8 × 29.0 mm (3.8 × 2.4 × 1.2 in.) (excluding projections)
Weight	Approx. 164 g (5.8 oz) (including batteries and SD memory card)
Operating environment	
Temperature	0°C–40°C (32°F–104°F)
Humidity	85% or less (no condensation)

- Unless otherwise stated, all figures assume fresh LR6/L40 (AA-size) alkaline batteries and an ambient temperature of 23 ± 3 °C (73.4 ± 5.4 °F) as specified by the Camera and Imaging Products Association (CIPA).

¹ Figures based on the Camera and Imaging Products Association (CIPA) standards for measuring the endurance of camera batteries. Performance for still pictures measured under the following test conditions: **20M 5152x3864** selected for **Image mode**, zoom adjusted with each shot, and flash fired with every other shot. Movie recording time assumes that **720p 720/30p** is selected for **Movie options**. Figures may vary with use, the interval between shots, and the length of time menus and images are displayed.

The included batteries are for trial use only. Figures listed for lithium batteries are measured using commercially available FR6/L91 (AA-size) Energizer(R) Ultimate Lithium batteries.

² Individual movie files can not exceed 2 GB in size or 29 minutes in length. Recording may end before this limit is reached if camera temperature becomes elevated.

Specifications

- Nikon will not be held liable for any errors this manual may contain.
- The appearance of this product and its specifications are subject to change without notice.

Approved Memory Cards

The following Secure Digital (SD) memory cards have been tested and approved for use in this camera.

- Memory cards with an SD Speed Class rating of 6 or faster are recommended for recording movies. When using a memory card with a lower Speed Class rating, movie recording may stop unexpectedly.

	SD memory card	SDHC memory card ²	SDXC memory card ³
SanDisk	2 GB ¹	4 GB, 8 GB, 16 GB, 32 GB	64 GB, 128 GB
TOSHIBA	2 GB ¹	4 GB, 8 GB, 16 GB, 32 GB	64 GB
Panasonic	2 GB ¹	4 GB, 8 GB, 16 GB, 32 GB	64 GB
Lexar	–	4 GB, 8 GB, 16 GB, 32 GB	64 GB, 128 GB

¹ If the memory card is used with a card reader or similar device, make sure that the device supports 2 GB cards.

² SDHC compliant.

If the memory card is used with a card reader or similar device, make sure that the device supports SDHC.



³ SDXC compliant.

If the memory card is used with a card reader or similar device, make sure that the device supports SDXC.



- Contact the manufacturer for details on the above cards. We cannot guarantee camera performance when using memory cards made by other manufacturers.

Supported Standards

- **DCF:** Design Rule for Camera File System is a standard widely used in the digital camera industry to ensure compatibility among different makes of camera.
- **DPOF:** Digital Print Order Format is an industry-wide standard that allows images to be printed from print orders saved on memory cards.
- **Exif version 2.3:** Exchangeable image file format (Exif) version 2.3 for digital still cameras is a standard that allows information saved with photographs to be used for optimal color reproduction when images are output from Exif-compliant printers.

- **PictBridge:** A standard developed cooperatively by the digital camera and printer industries, allowing photographs to be output directly to a printer without connecting the camera to a computer.

Trademark Information

- Microsoft, Windows and Windows Vista are either registered trademarks or trademarks of Microsoft Corporation in the United States and/or other countries.
- Macintosh, Mac OS, and QuickTime are trademarks of Apple Inc., registered in the U.S. and other countries.
- Adobe and Acrobat are registered trademarks of Adobe Systems Inc.
- SDXC, SDHC and SD Logos are trademarks of SD-3C, LLC.
- PictBridge is a trademark.
- All other trade names mentioned in this manual or the other documentation provided with your Nikon product are trademarks or registered trademarks of their respective holders.

FreeType License (FreeType2)





















Portions of this software are copyright © 2013 The FreeType Project (“www.freetype.org”). All rights reserved.

MIT License (Harfbuzz)









Portions of this software are copyright © 2013 The Harfbuzz Project (“<http://www.freedesktop.org/wiki/Software/HarfBuzz>”). All rights reserved.

Index







Symbols

AE/AF-L		4
T Telephoto		23
W Wide-angle		23
 Playback zoom		62
 Thumbnail playback		63
 Easy auto mode		32
 Scene mode		33
 Smart portrait mode		39
 Auto mode		42
 Playback mode		26
 Setup menu	82, 	43
 Apply selection button		3
 Shooting mode button		3
 Movie-record button		3
 Playback button		3, 26
 Delete button		3, 28
MENU button	3, 4, 54, 64, 77, 82	
 Flash mode		44
 Self-timer		47
 Macro mode		49
 Exposure compensation		51
 Help		34

A

AC adapter	11, 	66	
AF-assist illuminator	2, 82, 	53	
Alkaline batteries		10	
Aperture value		25	
Audio/video cable	66, 	12, 	66
Audio/video-in jack	66, 	12	
Auto flash		45	
Auto mode		42	
Auto off	19, 82, 	55	
Autofocus		50, 60	
Autofocus mode	77, 	42	
AVI			65

B

Backlighting 		37
Battery		10, 17
Battery chamber		3
Battery charger		66
Battery level		18
Battery type	83, 	64
Battery-chamber/memory card slot cover		3, 12
Beach 		35
Best shot selector	36, 	27
Black and white copy 		37
Black-and-white	55, 	28

Blink proof.....	55,	30
Blink warning.....	83,	58
Brightness.....		47
BSS.....	36,	27
Button sound.....		54

C

Calendar display.....		63
Charger.....		66
Close-up		36
Color options.....	55,	28
Compression ratio.....		22
Computer.....	66, 70	
Connector cover.....		3
Continuous shooting.....	55,	27
Copy.....	64,	38
Crop.....	62,	10
Cyanotype.....	55,	28

D

Date and time.....	14, 82,	44
Date format.....	15,	44
Daylight saving time.....	15,	46
Delete.....		28
Digital zoom.....		23
Direct print.....	66,	14
D-Lighting.....	64,	7
DPOF.....		19
DPOF print.....		21
DSCN.....		65

































Dusk/dawn		35
-----------	--	----

E

Easy auto mode.....		32
Electronic VR.....	82,	50
EN-MH1.....		4
EN-MH2.....	10,	66
Exposure compensation.....		51
Extension.....		65
Eye-Fi upload.....	83,	60
Eyellet for camera strap.....		2

F



Face detection.....		57
File name.....		65
Fill flash.....		45
Fireworks show		37
Firmware version.....	83,	64
Flash.....		2, 44
Flash lamp.....		3, 46
Flash mode.....		44
Flash off.....		45
Focus.....	24, 57	
Focus area.....		24
Focus indicator.....		7
Focus lock.....		59
Folder name.....		65
Food		36
Format internal memory.....	82,	56
Format memory cards.....	13, 82,	56

Formatting	13, 82, 	56	
FSCN.....		65	
Full-frame playback mode	26		
Full-time AF	77, 	42	
H			
Help	34		
I			
Identifier.....		65	
Image mode.....	55, 	22	
Internal memory.....	13		
J			
JPG.....		65	
L			
Landscape 	34		
Language.....	83, 	57	
Lens.....	2, 	15	
Lens cover.....	2		
Lithium batteries	10		
M			
Macro mode.....	49		
Memory capacity.....	18		
Memory card.....	12, 	19	
Memory card slot	3, 12		
Microphone.....	2		
Monitor.....	3, 6, 	7	
Monitor settings	82, 	47	
Motion detection.....	82, 	52	
Movie menu	77, 	40	
Movie options	77, 	40	
Movie playback.....	78		
Movie recording	74		
Movie recording time.....	74, 	41	
Movie-record button	3		
Multi selector.....	3		
Multi-shot 16.....		27	
Museum 	36		
N			
Nickel-metal hydride rechargeable batteries	10		
Night landscape 	35		
Night portrait 	35		
Nikon Transfer 2	69, 70		
Number of exposures remaining	18, 	23	
O			
Optical zoom	23		
Optional accessories.....		66	
P			
Panorama assist 	37, 	2	
Panorama Maker.....	37, 69, 	4	
Paper size		18, 	19
Party/indoor 	35		
Pet portrait auto release	38		
Pet portrait 	38		
Photo info.....		47	
PictBridge.....	66, 	14, 	19

Playback.....	26, 78	Setup menu.....	82, 43
Playback button.....	3, 26	Shooting.....	18, 22, 24
Playback menu.....	64, 31	Shooting menu.....	54, 22
Playback mode.....	26	Shooting mode button.....	3
Playback zoom.....	62	Shutter sound.....	54
Portrait	34	Shutter speed.....	25
Power.....	18, 19	Shutter-release button.....	2, 24
Power switch/power-on lamp... 2, 18, 19		Single AF.....	77, 42
Preset manual.....	25	Single-frame shooting.....	55, 27
Pressing halfway.....	25	Skin softening.....	55, 64, 8, 29
Print.....	64, 66, 17, 19, 31	Sleep mode.....	55
Print date.....	17, 82, 49	Slide show.....	64, 34
Print order.....	64, 31	Slow sync.....	45
Print order option.....	17, 32, 33	Small picture.....	64, 9
Printer.....	66, 14	Smart portrait menu.....	54, 29
Protect.....	64, 35	Smart portrait mode.....	39
R		Smile timer.....	55, 30
Rechargeable battery.....	66	Snow	35
Recording movies.....	74	Sound settings.....	82, 54
Red-eye reduction.....	45, 46	Speaker.....	3
Reset all.....	83, 61	Sports	34
Rotate image.....	64, 37	SSCN.....	65
RSCN.....	65	Standard color.....	55, 28
S		Strap.....	iii
Scene mode.....	33	Sunset	35
Self-timer.....	47	I	
Self-timer lamp.....	2, 48	Thumbnail display.....	63
Sepia.....	55, 28	Time difference.....	45

Time zone	15,  44
Time zone and date.....	14, 82,  44
Tripod socket	3,  17
TV	66,  12

U

USB cable	65, 70,  16
USB/audio/video output connector	3, 65, 70,  12,  14

V

Video mode	83,  58
ViewNX 2	67, 68
Vivid color	55,  28
Volume	79

W

Welcome screen.....	82,  43
White balance	55,  24

Z

Zoom	23
Zoom control	2, 23
Zoom in.....	23
Zoom out.....	23

No reproduction in any form of this manual, in whole or in part (except for brief quotation in critical articles or reviews), may be made without written authorization from NIKON CORPORATION.

NIKON CORPORATION

© 2013 Nikon Corporation



CT3A03(11)
6MN15911-03