

Nikon

En

The Nikon Guide to Digital Photography
with the

COOLPIX L1 L101

DIGITAL CAMERA

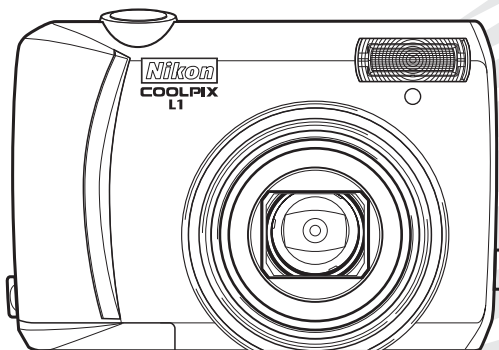

COOLPIX L1 / COOLPIX L101 (En)

CE

Trademark Information

Macintosh, Mac OS, and QuickTime are registered trademarks of Apple Computer, Inc. Microsoft and Windows are registered trademarks of Microsoft Corporation. The SD logo is a trademark of the SD Card Association. Adobe and Acrobat are registered trademarks of Adobe Systems Inc. PictBridge is a trademark. D-Lighting technology is provided by  Apical Limited. Face-priority AF technology is provided by Identix®. All other trade names mentioned in this manual or the other documentation provided with your Nikon product are trademarks or registered trademarks of their respective holders.

Symbols and Conventions

To make it easier to find the information you need, the following symbols and conventions are used:



This icon marks cautions, information that should be read before use to prevent damage to the camera.



This icon marks notes, information that should be read before using the camera.



This icon marks tips, additional information that may be helpful when using the camera.



This icon indicates that more information is available elsewhere in this manual or in the *Quick Start Guide*.

Memory Cards

Pictures taken with this camera can be stored in the camera's internal memory or on removable memory cards. If a memory card is inserted, all new pictures will be stored on the memory card and delete, playback, and format operations will apply only to the pictures on the memory card. The memory card must be removed before the internal memory can be formatted or used to store, delete, or view pictures.

Introduction

Basic Photography and Playback

Scene and Movie Modes

Viewing Pictures on the Camera

Connecting to Televisions, Computers, and Printers

**Basic Camera Setup:
The Setup Menu**

**Shooting Options:
The Shooting Menu**

**Playback Options:
The Playback Menu**

**Movie Options:
The Movie Menu**

Technical Notes

For Your Safety

To prevent damage to your Nikon product or injury to yourself or to others, read the following safety precautions in their entirety before using this equipment. Keep these safety instructions where all those who use the product will read them.

The consequences that could result from failure to observe the precautions listed in this section are indicated by the following symbol:



This icon marks warnings, information that should be read before using this Nikon product to prevent possible injury.

WARNINGS



Turn off in the event of malfunction

Should you notice smoke or an unusual smell coming from the camera or AC adapter, unplug the AC adapter and remove the batteries immediately, taking care to avoid burns. Continued operation could result in injury. After removing or disconnecting the power source, take the equipment to a Nikon-authorized service representative for inspection.



Do not disassemble

Touching the product's internal parts could result in injury. Repairs should be performed only by qualified technicians. Should the camera break open as the result of a fall or other accident, take the product to a Nikon-authorized service representative for inspection after unplugging the product and/or removing the batteries.



Do not use the camera or AC adapter in the presence of flammable gas

Do not use electronic equipment in the presence of flammable gas, as this could result in explosion or fire.



Handle the camera strap with care

Never place the strap around the neck of an infant or child.



Keep out of reach of children

Particular care should be taken to prevent infants from putting the batteries or other small parts into their mouths.



Observe caution when handling batteries

Batteries may leak or explode if improperly handled. Observe the following precautions when handling batteries for use in this product:

- Before replacing the batteries, turn the product off. If you are using an AC adapter, be sure it is unplugged.
- Use only the batteries listed on page 6 of this manual. Do not use other types. Do not mix old and new batteries or batteries of different makes or types.
- Charge and use each pair of Nikon rechargeable Nikon EN-MH1-B2 NiMH batteries together as a set. Do not mix batteries from different pairs.
- Insert batteries in the correct orientation.
- Do not short or disassemble batteries or attempt to remove or break the covering.
- Do not expose batteries to flame or to excessive heat.
- Do not immerse in or expose to water.
- Do not transport or store with metal objects such as necklaces or hairpins.
- Batteries are prone to leakage when fully discharged. To avoid damage to the product, be sure to remove the batteries when no charge remains.
- Discontinue use immediately should you notice any change in the batteries, such as discoloration or deformation.
- If liquid from damaged batteries comes in contact with clothing or skin, rinse immediately with plenty of water.

 **Observe the following precaution when handling the battery charger**

If an MH-71 battery charger is provided with the camera, observe the following precautions:

- Keep dry. Failure to observe this precaution could result in fire or electric shock.
- Dust on or near the metal parts of the plug should be removed with a dry cloth. Continued use could result in fire.
- Do not handle the power cable or go near the battery charger during thunderstorms. Failure to observe this precaution could result in electric shock.
- Do not damage, modify, forcibly tug or bend the power cable, place it under heavy objects, or expose it to heat or flame. Should the insulation be damaged and the wires become exposed, take it to a Nikon-authorized service representative for inspection. Failure to observe these precautions could result in fire or electric shock.
- Do not handle the plug or battery charger with wet hands. Failure to observe this precaution could result in electric shock.

 **Use appropriate cables**

When connecting cables to the input and output jacks, use only the cables provided or sold by Nikon for the purpose, to maintain compliance with product regulations.

 **Handle moving parts with care**

Be careful that your fingers or other objects are not pinched by the lens cover or other moving parts.

 **CD-ROMs**

The CD-ROMs supplied with this device should not be played back on audio CD equipment. Playing CD-ROMs on an audio CD player could cause hearing loss or damage the equipment.

 **Observe caution when operating the flash**

Using the flash close to your subject's eyes could cause temporary visual impairment. Particular care should be observed if photographing infants, when the flash should be no less than one meter (39 in.) from the subject.

 **Do not fire the flash while it is touching a person or object**

Such use can result in the person being burned, and/or their clothes igniting from the heat of the flash.

 **Avoid contact with liquid crystal**

Should the monitor break, care should be taken to avoid injury due to broken glass and to prevent liquid crystal from the monitor touching the skin or entering the eyes or mouth.

Notices

- No part of the manuals included with this product may be reproduced, transmitted, transcribed, stored in a retrieval system, or translated into any language in any form, by any means, without Nikon's prior written permission.
- Nikon reserves the right to change the specifications of the hardware and software described in these manuals at any time and without prior notice.
- Nikon will not be held liable for any damages resulting from the use of this product.
- While every effort has been made to ensure that the information in these manuals is accurate and complete, we would appreciate it were you to bring any errors or omissions to the attention of the Nikon representative in your area (address provided separately).

Notice for Customers in the U.S.A.

Federal Communications Commission (FCC) Radio Frequency Interference Statement

This equipment has been tested and found to comply with the limits for a Class B digital device, pursuant to Part 15 of the FCC rules. These limits are designed to provide reasonable protection against harmful interference in a residential installation. This equipment generates, uses, and can radiate radio frequency energy and, if not installed and used in accordance with the instructions, may cause harmful interference to radio communications. However, there is no guarantee that interference will not occur in a particular installation. If this equipment does cause harmful interference to radio or television reception, which can be determined by turning the equipment off and on, the user is encouraged to try to correct the interference by one or more of the following measures:

- Reorient or relocate the receiving antenna.
- Increase the separation between the equipment and receiver.
- Connect the equipment into an outlet on a circuit different from that to which the receiver is connected.
- Consult the dealer or an experienced radio/television technician for help.

Notice for Customers in Canada

CAUTION

This class B digital apparatus meets all requirements of the Canadian Interference Causing Equipment Regulations.

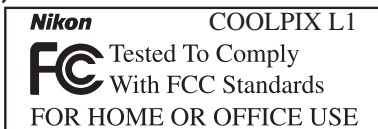

CAUTIONS

Modifications

The FCC requires the user to be notified that any changes or modifications made to this device that are not expressly approved by Nikon Corporation may void the user's authority to operate the equipment.

Interface Cables

Use the interface cables sold or provided by Nikon for your equipment. Using other interface cables may exceed the limits of Class B Part 15 of the FCC rules.

Notice for customers in the State of California

WARNING: Handling the cord on this product will expose you to lead, a chemical known to the State of California to cause birth defects or other reproductive harm. *Wash hands after handling.*

Nikon Inc.,
1300 Walt Whitman Road, Melville, New York
11747-3064, U.S.A. Tel.: 631-547-4200

ATTENTION

Cet appareil numérique de la classe B respecte toutes les exigences du Règlement sur le matériel brouilleur du Canada.

Symbol for Separate Collection in European Countries

This symbol indicates that this product is to be collected separately.



The following apply only to users in European countries:

- This product is designated for separate collection at an appropriate collection point. Do not dispose of as household waste.
- For more information, contact the retailer or the local authorities in charge of waste management.

Notice Concerning Prohibition of Copying or Reproduction

Note that simply being in possession of material that has been digitally copied or reproduced by means of a scanner, digital camera or other device may be punishable by law.

• Items prohibited by law from being copied or reproduced

Do not copy or reproduce paper money, coins, securities, government bonds, or local government bonds, even if such copies or reproductions are stamped "Sample."

The copying or reproduction of paper money, coins, or securities which are circulated in a foreign country is prohibited.

Unless the prior permission of the government has been obtained, the copying or reproduction of unused postage stamps or post cards issued by the government is prohibited.

The copying or reproduction of stamps issued by the government and of certified documents stipulated by law is prohibited.

• Cautions on certain copies and reproductions

The government has issued cautions on copies or reproductions of securities issued by private companies (shares, bills, checks, gift certificates, etc.), commuter passes, or coupon tickets, except when a minimum of necessary copies are to be provided for business use by a company. Also, do not copy or reproduce passports issued by the government, licenses issued by public agencies and private groups, ID cards, and tickets, such as passes and meal coupons.

• Comply with copyright notices

The copying or reproduction of copyrighted creative works such as books, music, paintings, woodcut prints, maps, drawings, movies, and photographs is governed by national and international copyright laws. Do not use this product for the purpose of making illegal copies or to infringe copyright laws.

Disposing of Data Storage Devices

Please note that deleting images or formatting data storage devices such as memory cards or built-in camera memory does not completely erase the original image data. Deleted files can sometimes be recovered from discarded storage devices using commercially available software, potentially resulting in the malicious use of personal image data. Ensuring the privacy of such data is the user's responsibility.

Before discarding a data storage device or transferring ownership to another person, erase all data using commercial deletion software, or format the device and then completely refill it with images containing no private information (for example, pictures of empty sky). Be sure to also replace any pictures selected for the welcome screen. Care should be taken to avoid injury or damage to property when physically destroying data storage devices.

Table of Contents

For Your Safety	ii
Introduction	1
Parts of the Camera	2
The Monitor	4
First Steps.....	6
Inserting Batteries	6
Basic Setup.....	7
Inserting Memory Cards.....	9
Basic Photography and Playback	10
📷 Mode	10
Viewing Pictures.....	13
Using the Flash	14
Taking Pictures with the Self-Timer	15
Macro Close-up Mode.....	16
Exposure Compensation	16
Scene and Movie Modes	17
Scene Mode	17
Assist Modes	18
Other Scenes	22
Movie Mode	25
Viewing Pictures on the Camera	26
Viewing Multiple Pictures: Thumbnail Playback.....	26
Deleting Pictures.....	26
Taking a Closer Look: Playback Zoom	27
Enhancing Contrast: D-Lighting.....	28
Voice Memos: Recording and Playback.....	29
Movie Playback	30
Connecting to Televisions, Computers, and Printers	31
Viewing Pictures on TV	31
Viewing Pictures on a Computer	31
Printing Pictures	34
Menus	39
Basic Camera Setup: The Setup Menu.....	41
Welcome Screen	41
Date	42
Monitor Settings.....	43
Date Imprint.....	44
Sound Settings.....	45
Blur Warning	45
Auto Off	45

Format Memory/ Format Card	46
Language	46
Interface	46
Reset all	47
Battery Type	47
Menus	47
Firmware Version	47
Shooting Options: The Shooting Menu	48
Image Mode	48
White Balance	49
Metering	50
Continuous	51
BSS	51
Color Options	52
AF-Area Mode	52
Auto-focus Mode	52
Playback Options: The Playback Menu	54
Print Set	54
Slide Show	54
Delete	55
Protect	55
Transfer Marking	55
Small Pic	56
Copy	56
Movie Options: The Movie Menu	57
Movie Options	57
Auto-focus Mode	57
Technical Notes	58
Optional Accessories	58
Caring for the Camera	59
Cleaning	60
Storage	60
Error Messages	61
Troubleshooting	63
Appendix	66
Specifications	70
Index	72

Use Only Nikon Brand Electronic Accessories

Nikon COOLPIX cameras are designed to the highest standards and include complex electronic circuitry. Only Nikon brand electronic accessories (including battery chargers, batteries, and AC adapters) certified by Nikon specifically for use with this Nikon digital camera are engineered and proven to operate within the operational and safety requirements of this electronic circuitry.

THE USE OF NON-NIKON ELECTRONIC ACCESSORIES COULD DAMAGE THE CAMERA AND MAY VOID YOUR NIKON WARRANTY.

For more information about Nikon brand accessories, contact a local authorized Nikon dealer.

Introduction

Thank you for your purchase of a Nikon COOLPIX L1/L101 digital camera. This manual has been written to help you enjoy taking pictures with your Nikon digital camera. Read this manual thoroughly before use, and keep it where all those who use the product will read it.

The documentation for this product also includes the manuals listed below. Please be sure to read all instructions thoroughly to get the most from the camera.

- *Quick Start Guide*: The Quick Start Guide takes you through the process of unpacking and setting up your Nikon digital camera, taking your first photographs, and transferring them to your computer.
- *PictureProject Reference Manual* (on CD): The *PictureProject Reference Manual* contains information on using the PictureProject software provided with your camera. For information on viewing the reference manual, see the *Quick Start Guide*.

The illustrations in this manual and the *Quick Start Guide* show the COOLPIX L1.

Before Taking Important Pictures

Before taking pictures on important occasions (such as at weddings or before taking the camera on a trip), take a test shot to ensure that the camera is functioning normally. Nikon will not be held liable for damages or lost profits that may result from product malfunction.

Life-Long Learning

As part of Nikon's "Life-Long Learning" commitment to ongoing product support and education, continually-updated information is available on-line at the following sites:

- For users in the U.S.A.: <http://www.nikonusa.com/>
- For users in Europe and Africa: <http://www.europe-nikon.com/support>
- For users in Asia, Oceania, and the Middle East: <http://www.nikon-asia.com/>

Visit these sites to keep up-to-date with the latest product information, tips, answers to frequently-asked questions (FAQs), and general advice on digital imaging and photography. Additional information may be available from the Nikon representative in your area. See the URL below for contact information:

<http://nikonimaging.com/>

Parts of the Camera

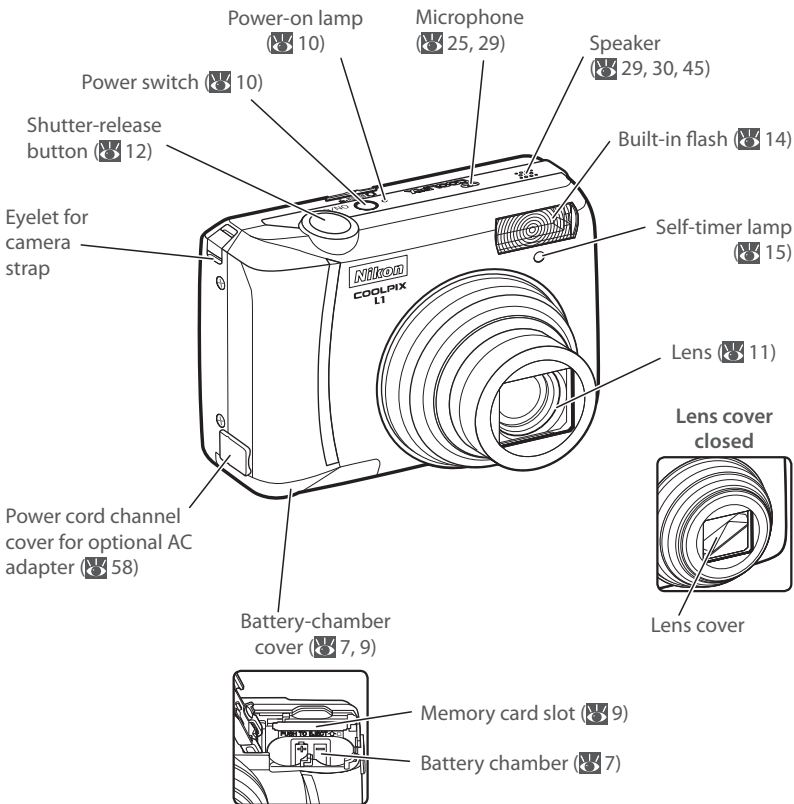

Attaching the Camera Strap

Attach the strap as shown at right.

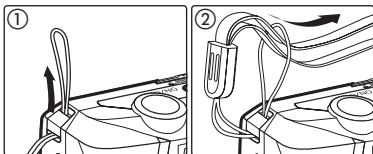

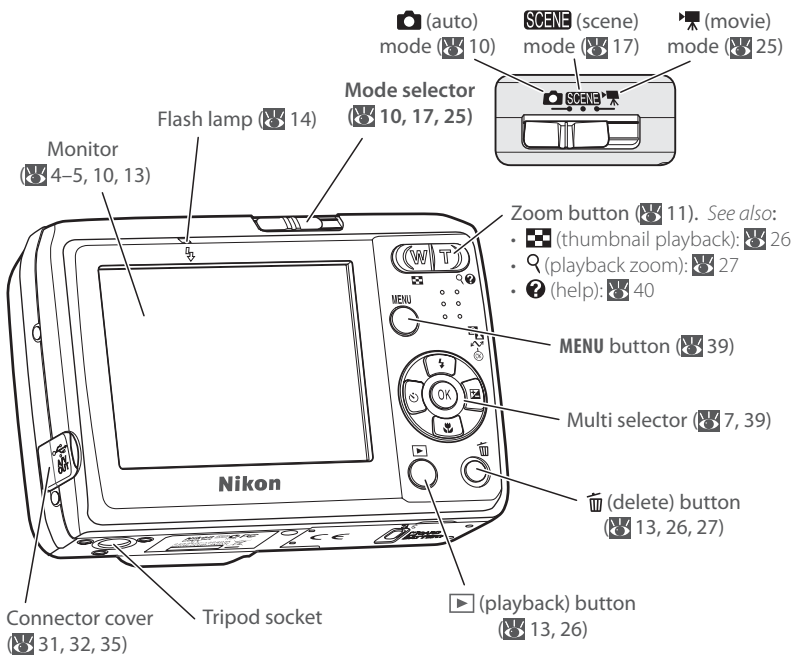

Replacing the connector cover

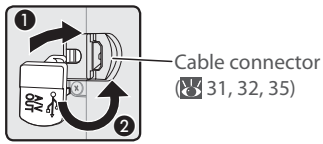

The Multi Selector

Press the multi selector up, down, left, or right to highlight pictures and menu items, then press the center to select. The buttons on the multi selector are also used to:

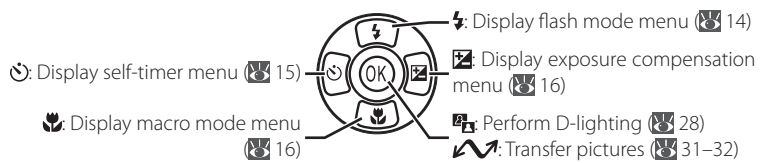

The Monitor

The following indicators may appear in the monitor during shooting and playback (actual display varies with current camera settings):

Shooting

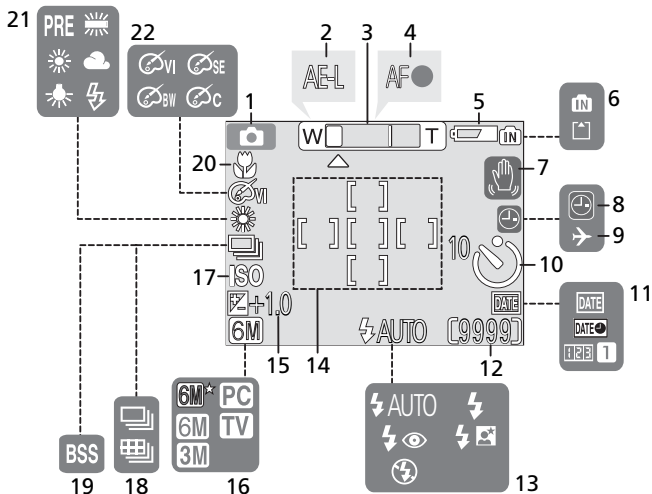

Playback

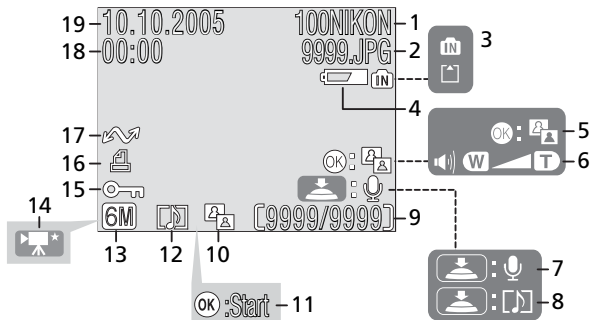

- | | | | | | |
|----|---|------------|----|-------------------------------------|--------|
| 1 | Shooting mode | 10, 17, 25 | 12 | Number of exposures remaining | 10, 67 |
| 2 | Exposure lock | 24 | | Movie length | 25, 67 |
| 3 | Zoom indicator | 11, 16 | 13 | Flash mode | 14 |
| 4 | Focus indicator | 12 | 14 | Focus areas | 12, 52 |
| 5 | Battery level indicator | 10 | 15 | Exposure compensation | 16 |
| 6 | Internal memory/memory card indicator | 9 | 16 | Image mode | 48, 67 |
| 7 | Camera shake icon | 12 | 17 | Sensitivity | 12 |
| 8 | "Date not set" indicator | 61 | 18 | Continuous shooting mode | 51 |
| 9 | Time zone indicator | 42 | 19 | Best Shot Selector (BSS) | 51 |
| 10 | Self-timer indicator | 15 | 20 | Macro close-up mode | 16 |
| 11 | Date imprint/date counter | 44 | 21 | White balance | 49 |
| | | | 22 | Color option | 52 |
| 1 | Current folder | 68 | 10 | D-Lighting icon | 28 |
| 2 | File number and type | 68 | 11 | Movie playback indicator | 30 |
| 3 | Internal memory/memory card indicator | 9 | 12 | Voice memo icon | 29 |
| 4 | Battery level indicator | 10 | 13 | Image mode | 48 |
| 5 | D-Lighting guide | 28 | 14 | Movie indicator | 30 |
| 6 | Volume indicator | 29, 30 | 15 | Protect icon | 55 |
| 7 | Voice memo recording guide | 29 | 16 | Print-order icon | 38 |
| 8 | Voice memo playback guide | 29 | 17 | Transfer icon | 32, 55 |
| 9 | Current frame number/
total number of frames | | 18 | Time of recording | 7-8 |
| | Movie length | 30 | 19 | Date of recording | 7-8 |

First Steps

Inserting Batteries

The camera uses two AA batteries. Depending on the country or region of purchase, the package will include *either* alkaline batteries *or* an MH-71 battery charger with rechargeable EN-MH1-B2 batteries.

1 Charge the batteries (EN-MH1-B2 batteries only)

If the camera came with a battery charger and rechargeable Nikon EN-MH1-B2 NiMH batteries, charge the batteries as described below. If the camera came with a pair of alkaline batteries, skip to Step 2 on the following page.

1.1 Plug the charger in

Connect the power cable to the charger (①) and then plug it into a power outlet (②). The CHARGE lamp will light (③).

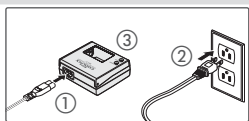

1.2 Charge the batteries

Insert the batteries as indicated on the charger. The CHARGE lamp will start to blink. Charging is complete when the CHARGE lamp stops blinking.

A pair of new or fully exhausted batteries will charge in about two and a half hours.

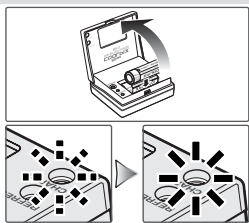

✓ Batteries

Read and follow the warnings and cautions on pages ii–iii and 59 of this manual. The camera can be used with AA alkaline (LR6) batteries, Nikon rechargeable EN-MH1-B2 NiMH batteries, ZR6 oxy-nickel batteries, and FR6/L91 lithium batteries. Do not mix old and new batteries or batteries of different makes or types. Batteries with the following defects can not be used:

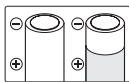

Peeling or damaged insulation



Insulation does not reach negative terminal

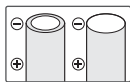

Flat negative terminal

✏ EN-MH1-B2 Batteries

Charge EN-MH1-B2 batteries before first use. Charge and use as a set: do not charge batteries one at a time or mix batteries from different pairs. Note that the batteries may tend to discharge more quickly when new or after a long period of disuse. The batteries will retain a charge longer once they have been used and recharged several times. “Memory” effects that result in reduced battery capacity can be avoided by periodically refreshing the batteries as described in the Appendix (📖 69).

2 Insert the batteries

✓ Is the Camera Off?

Confirm that the power-on lamp is off before inserting or removing batteries.

2.1 Open the battery chamber

Hold the camera upside down to prevent the batteries from falling out.

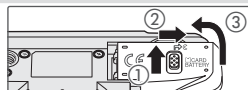

2.2 Insert the batteries

Insert the batteries as shown.

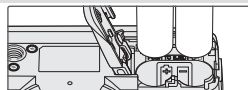

2.3 Close the battery chamber

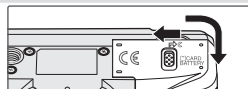

✎ The Battery Type Menu

After replacing the batteries, check that the option selected for **Battery Type** in the setup menu matches the type of battery used (47).

Basic Setup

A language-selection dialog is displayed the first time the camera is turned on. Choose a language and set the time and date as described below.

🗨 The Multi Selector

The multi selector is used in the steps that follow. The buttons needed to perform a task are shown in black; if more than one button is highlighted, any of the highlighted buttons can be used. For example, “press the multi selector up or down” is shown as illustrated at right.

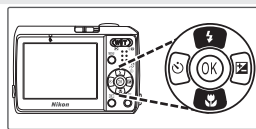

1



Turn camera on.



2



Highlight language.



3

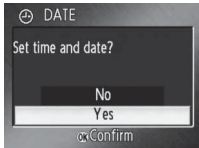

Confirmation dialog displayed.

4



TIME ZONE menu displayed.*

* If daylight saving time is in effect, press multi selector down to highlight **DaylightSaving** and press center of multi selector.

5



Display map of world time zones.

6



Select home time zone.

7



Display DATE menu.

8



Edit Day (order of Day, Month, and Year may differ in some areas).

9



Select Month. Repeat steps 8–9 to edit Month, Year, hour, and minute.

10



Highlight D M Y.

11



Choose date display order.

12



EXIT DATE menu. Camera is now ready for use.

Inserting Memory Cards

Pictures are stored in the camera's internal memory (approximately 10 MB) or on removable Secure Digital (SD) memory cards (58). Internal memory is used for recording and deleting pictures only if no memory card is inserted.

To insert a memory card:

- 1 **Turn the camera off**
Confirm that the power-on lamp is off before inserting or removing memory cards.



- 2 **Insert the memory card**
Open the battery chamber, holding the camera upside down to keep the batteries from falling out. Slide the memory card in as shown until it clicks into place. Close the battery chamber.

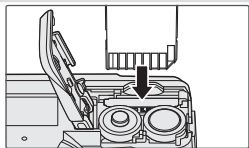

- 3 **Turn the camera on**
If no message is displayed in the monitor, the camera is ready for use.



If the message shown at right is displayed, the memory card must be formatted before use. Note that **formatting permanently deletes all pictures** and other data on the memory card. Be sure to make copies of any pictures you wish to keep before beginning formatting.

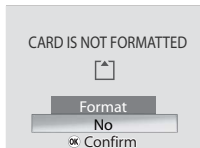

To begin formatting, press the multi selector up to highlight **Format** and then press the center of the multi selector. **Do not turn the camera off or remove the batteries or memory card until formatting is complete.**

Removing Memory Cards

Before removing memory cards, **turn the camera off** and confirm that the power-on lamp is off. Open the battery-chamber cover and press the card in to partially eject the card. The card can then be removed by hand.

The Write Protect Switch

SD cards are equipped with a write protect switch. Pictures can not be recorded or deleted and the memory card can not be formatted when this switch is in the "lock" position.

Write protect switch

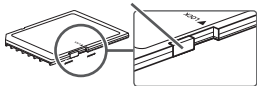

Basic Photography and Playback

Mode

This section describes how to take pictures in  (auto) mode, an automatic, “point-and-shoot” mode recommended for first-time users of digital cameras.

- 1 Select  mode
Slide the mode selector to .

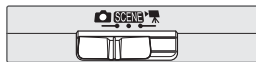

- 2 Turn the camera on

2.1 Turn the camera on

The power-on lamp will light and the monitor will turn on. To turn the camera off at any time, press the power switch again. Do not remove the batteries while the power-on lamp is lit.

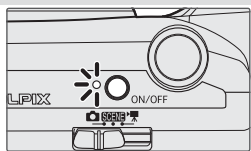

2.2 Check indicators in the monitor

Check the battery level and number of exposures remaining.

Display	Battery level
NO ICON	Batteries fully charged.
	Low battery; ready spare batteries.
WARNING!! BATTERY EXHAUSTED	Batteries exhausted. Replace batteries.

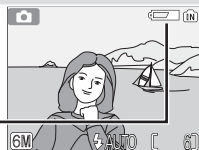

Number of exposures remaining (67)

Auto Power off (Stand-by Mode)

If no operations are performed for about a minute, the monitor will turn off and the camera will enter stand-by mode to reduce the drain on the battery. While the camera is in stand-by mode, the power-on lamp will blink and the monitor can be reactivated by pressing the shutter-release button halfway. The camera will turn off automatically if no operations are performed for another three minutes.

3 Frame a picture

3.1 Ready the camera

Hold the camera steadily in both hands, keeping your fingers and other objects away from the lens, flash, and microphone.

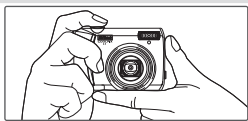

3.2 Frame the picture

Frame the subject near the center of the monitor.



Zoom

Use the **W** **T** button to frame the subject in the monitor. Press **W** to zoom out, increasing the area visible in the frame. Press **T** to zoom in up to 5 \times so that the subject fills a larger area of the frame. Pressing **T** for about two seconds at 5 \times zoom will trigger digital zoom, allowing the subject to be magnified up to 4 \times more, for a total of magnification of 20 \times . Note that unlike optical zoom, digital zoom does not increase the amount of detail visible in the picture. Instead, details visible at 5 \times zoom are simply enlarged, producing a slightly "grainy" image.



Zoom out Zoom in



Zoom indicator turns yellow when digital zoom is in effect.

4 Focus and shoot

4.1 Focus

Press the shutter-release button halfway. The camera will select the focus area (4-5) containing the subject closest to the camera. If the camera is able to focus on this subject, the focus (AF●) indicator and focus area will be displayed in green. If they blink red, the camera was unable to focus. Change the composition and try again.



4.2 Take the picture

Press the shutter release the rest of the way down to take the picture. Note that the flash may fire if the subject is poorly lit.



The Shutter-Release Button

To set focus and exposure, lightly press the shutter-release button about halfway, stopping when you feel resistance (②). Focus and exposure lock while the shutter-release button is held in this position. To release the shutter and take a picture, press the shutter-release button down the rest of the way (③). Use a gentle touch; moving the camera while pressing the shutter-release button can result in blurred pictures.

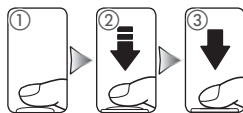

When Lighting Is Poor

If lighting is poor and the flash is off, a  icon will be displayed to warn that pictures may be blurred as a result of the slow shutter speeds. If an **ISO** icon is displayed, sensitivity has been raised to compensate for poor lighting and pictures may be affected by "noise" in the form of randomly-spaced, brightly-colored dots. The camera may process pictures to reduce noise, doubling recording times.

If the warning at right is displayed after a picture is taken, the picture may be blurred. Select **No** to exit without recording the picture.



Viewing Pictures

Press the  button to display a picture in the monitor. Use the multi selector to view additional pictures: press the multi selector down or right to view pictures in the order recorded, up or left to view pictures in reverse order. Keep the multi selector pressed to scroll quickly to the desired picture. Pictures may be displayed briefly at low resolution while being read from memory.

Press the  button again to return to shooting mode.



Deleting Unwanted Pictures

To delete the picture currently displayed in the monitor, press the  button. A confirmation dialog will be displayed; highlight one of the following options and press the center of the multi selector:

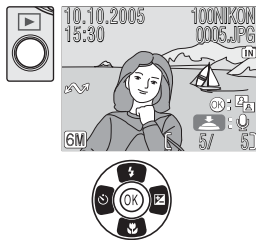

- **No:** Exit without deleting the picture.
- **Yes:** Delete the picture.



During Recording

The  or  icon will blink while pictures are recorded. Removing memory cards or batteries while these icons are blinking could affect pictures or damage the camera or card.

Auto Mode

In addition to the flash, self-timer, and macro close-up options described on pages 14–16,  (auto) mode offers a menu of shooting options controlling such settings as image size, picture color, and white balance  48–53).

Using the Flash

The flash has a range of 0.5–3.5 m (1 ft. 8 in.–11 ft. 6 in.) when the camera is zoomed all the way out. The range at maximum zoom is 0.5–2 m (1 ft. 8 in.–6 ft. 7 in.). The following flash modes are available:

Mode	Description
AUTO Auto	Flash fires automatically when lighting is poor.
Auto with red-eye reduction	Reduces “red eye” in portraits (see below).
Off	Flash will not fire even when lighting is poor.
Fill flash	Flash fires whenever picture is taken. Use to “fill-in” (illuminate) shadows and back-lit subjects.
Slow sync	Flash illuminates main subject; slow shutter speeds are used to capture background at night or under dim light.

1

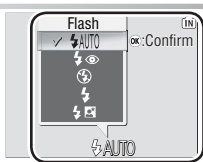

Display options.

2

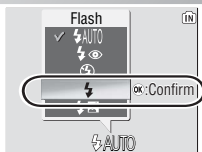

Highlight mode.

3

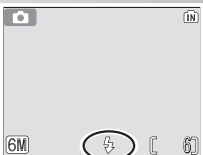

Make selection (to exit without changing mode, wait two seconds). Selection is shown by icon at bottom of display. Selection for mode is stored in memory even when camera is off.

Red-eye Reduction

The camera uses *advanced red-eye reduction*. Low-intensity light pulses cause the subject's pupils to contract before the flash fires. If the camera still detects red-eye, it will process the image to further its effects (this may slightly increase the time needed to record the picture). This mode is not recommended where a quick shutter response is required; if the desired results are not achieved, try again at a different flash setting.

The Flash Lamp

The flash lamp shows flash status when the shutter-release button is pressed halfway.

- **On:** Flash will fire when picture is taken
- **Blinks:** Flash charging. Wait a few seconds and try again.
- **Off:** Flash will not fire when picture is taken.

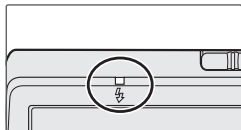

Taking Pictures with the Self-Timer

The camera is equipped with a ten-second timer for self-portraits. When using the self-timer, mount the camera on a tripod (recommended) or rest it on a flat, level surface.

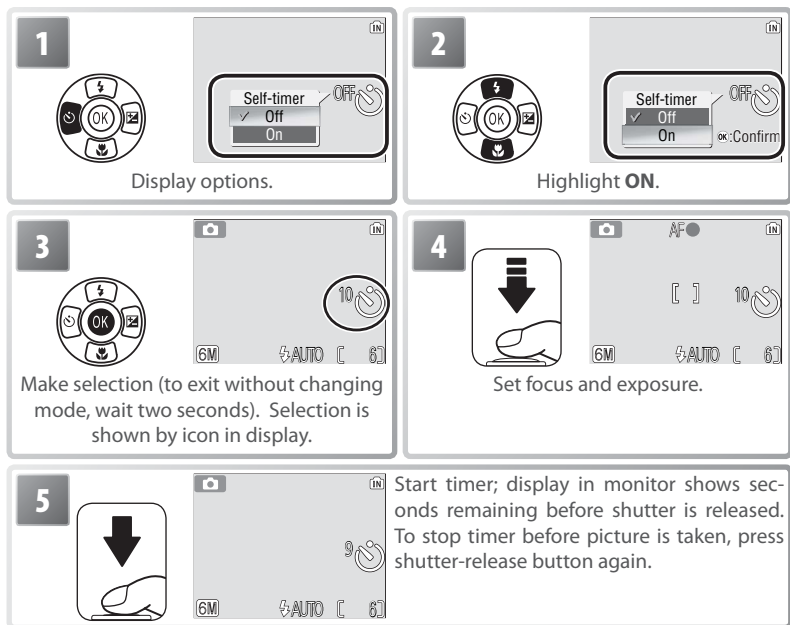

The self-timer lamp will blink until one second before the picture is taken, staying lit during the final second to warn that the shutter is about to be released.



Macro Close-up Mode

Macro close-up mode is used for taking shots of objects as close as 4 cm (1.6 in.).

1

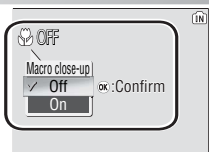

Display options.

2

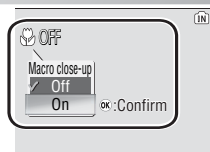

Highlight ON.

3



Make selection (to exit without changing mode, wait two seconds). Selection is shown by icon in display.

4



Frame picture. Minimum focus distance varies with zoom position; if zoom is adjusted until  icon turns green, camera can focus at distance of 4 cm (1.6 in.).

5

Focus and shoot. Note that flash may be unable to light entire subject at distances of less than 50 cm (1 ft. 8 in.); if flash fires, play picture back and check results.

Exposure Compensation

Use exposure compensation to make the entire picture brighter or darker.

1

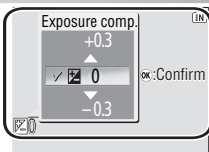

Display options.

2

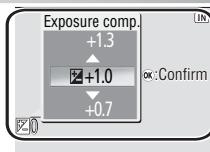

Highlight option.

3



Make selection (to exit without changing selection, wait two seconds). If positive value is selected, pictures will be brighter; if negative value is selected, pictures will be darker.  icon is displayed in monitor.

Scene and Movie Modes

Scene Mode

Scene mode offers a choice of eleven “scene” and four “assist” settings. Camera settings are automatically optimized for the selected subject type.



Assist modes offer framing assist options to help compose shots:

Mode	Description
Portrait	For portraits.
Landscape	For landscapes.
Sports	For moving subjects.
Night Portrait	For portraits taken against a backdrop of night scenery.

The remaining scene modes cover the following subject types:

Party/Indoor	Night Landscape	Copy
Beach/Snow	Close Up	Back Light
Sunset	Museum	Panorama Assist
Dusk/Dawn	Fireworks Show	

Image Mode

Image mode (48) can be adjusted by selecting from the scene mode menu.



Flash Mode, Self-Timer, Macro Close-Up, and Exposure Compensation

See the Appendix for information on the settings available in scene mode (67).



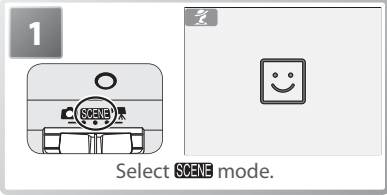

Assist Modes

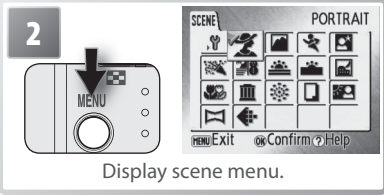
These modes offer a selection of framing assist options that allow you to compose pictures with the help of framing guides displayed in the monitor.

- 

1 Select **SCENE** mode.
- 

2 Display scene menu.
- 

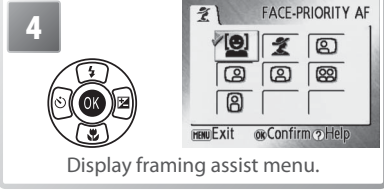
3 Highlight , , , or .
- 

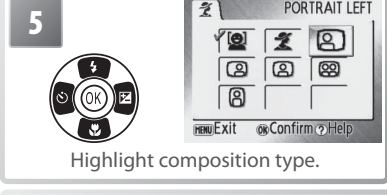
4 Display framing assist menu.
- 

5 Highlight composition type.
- 

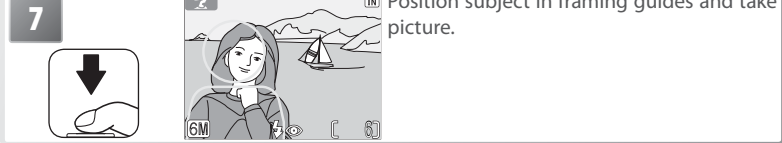







6 Framing guides displayed in monitor.
- 

7 Position subject in framing guides and take picture.

Portrait Assist

Use for smooth, natural-looking portraits. Pictures taken at slow shutter speeds are processed to reduce noise ( 12).







 Face-priority AF	Camera automatically focuses on face of portrait subject ( 20).
 PORTRAIT	Camera focuses on subject in center of monitor. No guides are displayed.
 Portrait Left	Compose shot with subject in left or right half of frame. Camera focuses on subject in framing guide.
 Portrait Right	
 Portrait Close-up	Compose shot with subject's face in top half of frame. Camera focuses on face area in framing guide.
 Portrait Couple	Compose shot with two subjects side-by-side. Camera focuses on subject in framing guide.
 Portrait Figure	Compose shot in "tall" orientation. Camera focuses on subject in framing guide.

Landscape Assist

Use for vivid landscapes or portraits that feature a landmark in the background. Pictures taken at slow shutter speeds are processed to reduce noise ( 12).





 LANDSCAPE	Camera focuses at infinity; no guides are displayed in monitor.*
 Scenic View	Use to photograph distant skylines. Camera focuses at infinity.*
 Architecture	Use to photograph buildings. Camera focuses at infinity.*
 Group Right	Compose shots with landmark to left or right of portrait subjects.
 Group Left	Camera uses portrait subjects to set focus and exposure.

* Focus indicator ( 12) is always displayed in green when shutter-release button is pressed halfway; note, however, that foreground objects may not always be in focus.

Taking Pictures with Face-Priority AF (19)

1





Highlight  and press center of multi selector.  icon blinks in monitor.

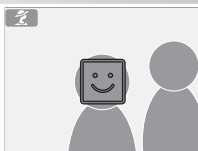

2



Frame picture using size of  icon as a guide. Closest portrait subject is indicated by double yellow border.*

* If camera detects multiple faces, closest subject will be indicated by double border, other subjects by single border. Camera will focus on closest subject. If camera can no longer detect subject (for example, because subject has looked away from camera), borders will no longer be displayed and  icon will blink in monitor.

3



Set focus and exposure.
Double border turns green.

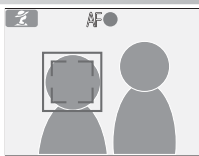

4



Take picture.

Face-Priority AF



The camera's ability to detect faces depends on a variety of factors, including whether or not the subject is facing the camera. The camera may be unable to detect faces that are hidden by sunglasses or other obstructions or that take up too much or too little of the frame. If no face is detected when the shutter-release button is pressed halfway, the camera will focus on the center of the frame.

The camera will focus continuously until a face detected. If the double border flashes yellow when the shutter-release button is pressed halfway, the camera is unable to focus; release the button and try again.

Sports Assist

Capture motion in a series of high-speed shots. No framing guides are displayed.



 SPORTS	Camera shoots about 0.7 frames per second (fps) while shutter-release button is pressed. Camera focuses continuously even when shutter-release button is not pressed.
 Sport Spectator	As above, except that camera focuses at about 1.5 m/5 ft. (20 m/65 ft. at maximum zoom) to infinity for improved shutter response.
 Sport Composite	Each time shutter-release button is pressed, camera takes 16 shots in about 2 seconds and arranges them in single picture 2,816 x 2,112 pixels in size. Camera focuses continuously even when shutter-release button is not pressed.



Night Portrait Assist

Use for a natural balance between the main subject and background lighting in portraits shot at night. With the exception of face-priority AF, this mode offers the same assist options as portrait assist mode. Pictures taken at slow shutter speeds are processed to reduce noise ( 12); to prevent blurring, mount the camera on a tripod or rest it on a flat, stable surface.

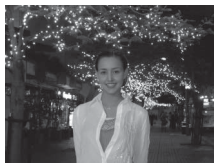





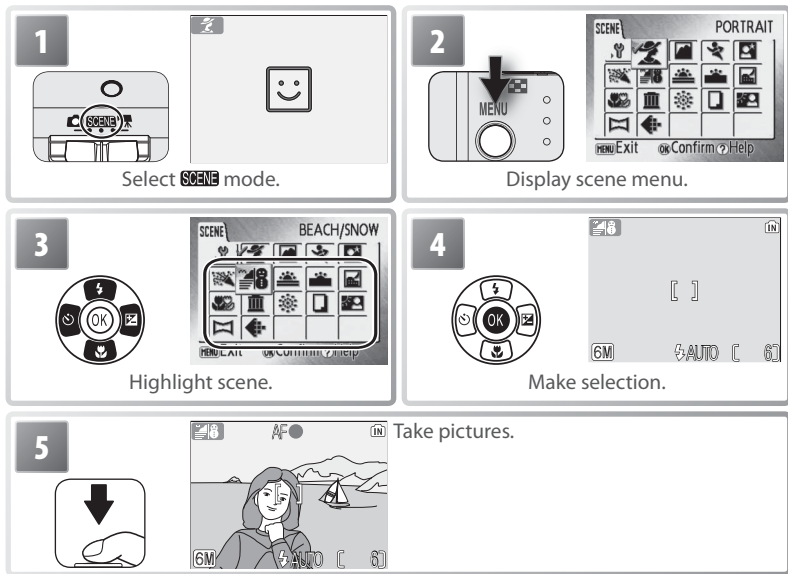

Other Scenes

To take pictures in other scene modes:



The following modes are available:

 Party/Indoor	
Captures the effects of candlelight and other indoor background lighting. Camera focuses on subject in center of frame. Hold camera steady to prevent blurring; pictures may be processed to reduce noise (12).	
 Beach/Snow	
Captures the brightness of such subjects as snowfields, beaches, or sunlit expanses of water. Camera focuses on subject in center of frame.	
 Sunset	
Preserves the deep hues seen in sunsets and sunrises. Camera focuses at infinity.* Hold camera steady to prevent blurring; pictures may be processed to reduce noise (12).	

* Focus indicator (12) is always displayed in green when shutter-release button is pressed halfway; note, however, that foreground objects may not always be in focus.

Dusk/Dawn

Preserves the colors seen in the weak natural light before sunrise or after sunset. Camera focuses at infinity.* Use of a tripod recommended to prevent blurring; pictures may be processed to reduce noise (12).

**Night Landscape**

Slow shutter speeds are used to produce stunning night landscapes. Camera focuses at infinity.* Use of a tripod recommended to prevent blurring; pictures may be processed to reduce noise (12).

**Close Up**

Photograph flowers, insects, and other small objects at close range (16). Camera focuses continuously until shutter-release button is pressed halfway to lock focus. Hold camera steady to prevent blurring; pictures may be processed to reduce noise (12).

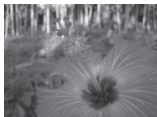
**Museum**

Use indoors where flash photography is prohibited (for example, in museums and art galleries) or in other settings in which you do not want to use the flash. Camera focuses on subject in center of frame; BSS (51) turns on automatically. Hold camera steady to prevent blurring.

**Fireworks Show**

Slow shutter speeds are used to capture the expanding burst of light from a firework. Focus is fixed at infinity.* Use of a tripod recommended to prevent blurring.

**Copy**

Provides clear pictures of text or drawings on a white board or in print. Camera focuses on subject in center of frame; use macro close-up (16) to focus at short ranges. Colored text and drawings may not show up well. Pictures may be processed to reduce noise (12).

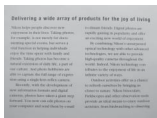
**Back Light**

Use when light is coming from behind a portrait subject, throwing their features into shadow. The flash fires automatically to “fill in” (illuminate) shadows. Camera focuses on subject in center of frame.

**Panorama Assist**

Use when taking a series of pictures that will later be joined side-by-side in PictureProject to form a panorama (24).

* Focus indicator (12) is always displayed in green when shutter-release button is pressed halfway; note, however, that foreground objects may not always be in focus.

Taking Pictures for a Panorama (P 23)

The camera focuses on the subject in the center of the frame. Use a tripod for better results.

1

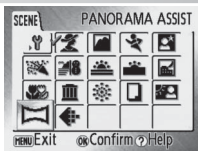

Highlight  (**Panorama assist**) and press center of multi selector.

2



Take first shot. About $\frac{1}{3}$ of picture is displayed in monitor. **AE-L** icon is displayed to show that white balance and exposure have been locked at values for first shot.

3



Compose next shot to overlap with previous picture and take next photograph. Repeat until all shots in series have been taken.

4







End series and return to Step 2.

Panorama Assist

Flash mode (P 14), self-timer (P 15), macro close-up (P 16), and exposure compensation (P 16) can not be adjusted after the first picture is taken. Pictures can not be deleted or zoom or image mode (P 48) adjusted until shooting is complete.

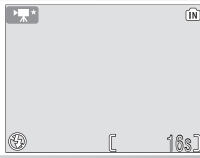

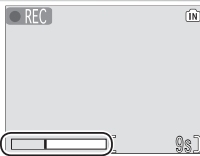

Movie Mode

Follow the steps below to shoot movies with sound recorded via the built-in microphone. Movies recorded to internal memory at the default setting of **Small Size 320★** can be up to 16 seconds long; a 256 MB memory card can hold up to 6 minutes 30 seconds.

1		Select  mode. Exposure count display shows maximum total length of movie that can be recorded.
2		Start recording. Progress bar shows amount of memory remaining.
3		End recording.



See “Movie Options: The Movie Menu”  57) for information on movie size and focus options.

Recording Movies





The flash  14), self-timer  15), exposure compensation  16), and digital zoom  11) are not available in movie mode. Macro close-up can be used  16). Zoom can not be adjusted during recording.



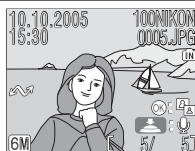

See the Appendix for information on the maximum total length of movie that can be recorded  67).

Viewing Pictures on the Camera



To view pictures full-frame in the monitor (*full-frame playback*), press the  button (if the camera is off, pressing the  button for about two seconds will turn the camera on in playback mode). The following operations can be performed:





To	Press	
View next picture		13
View previous picture		13
Delete picture		13
Zoom picture in	T (Q)	27





To	Press	
View thumbnails	W 	—
View playback menu	MENU	54
Record/play voice memo	Shutter button	29
Still: Enhance contrast		28
Movie: Play movie		30
Exit to shooting mode		—

Viewing Multiple Pictures: Thumbnail Playback

Pressing the   button in full-frame playback displays pictures in “contact sheets” of four or nine thumbnail images. The following operations can be performed while thumbnails are displayed:



To	Press	
Highlight picture		—
Change number of pictures displayed	W  / T (Q)	—

To	Press	
Delete highlighted picture		—
Exit to full-frame playback		—
View playback menu	MENU	54
Exit to shooting mode		—

Deleting Pictures

Pressing the  button in full-frame or thumbnail playback displays the dialog shown at right. Highlight **Yes** and press the center of the multi selector to delete the selected picture.

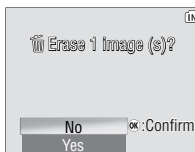

Viewing Pictures in Internal Memory

Pictures in internal memory can only be viewed if no memory card is inserted.

Taking a Closer Look: Playback Zoom

During full-frame playback (📷 26), the **T** (Q) button can be used to zoom in on pictures to a maximum of 8x. The following operations can be performed while pictures are zoomed in:



To	Press	📷
Zoom in	T (Q)	—
Zoom out	W (📷)	—
View other areas of picture		—
Delete picture		26
View playback menu	MENU	54
Exit to full-frame playback	OK	26
Create cropped copy (see below)	Shutter button	—
Exit to shooting mode		—

Creating a Cropped Copy

If a icon is displayed in the monitor during playback zoom, the portion of the picture currently visible in the monitor can be saved to a separate file. Pressing the shutter-release button displays the dialog shown at right; highlight **Yes** and press the center of the multi selector to create a new picture containing only the area visible in the monitor.



Cropped Copies

Cropped copies may not display or transfer correctly when viewed on other models of Nikon camera. See the Appendix for more information on cropped copies (📷 69).

Enhancing Contrast: D-Lighting

If a  icon appears on a picture during full-frame playback (▶ 26), D-lighting can be used to create a copy with enhanced brightness and contrast, brightening dark and backlit subjects.

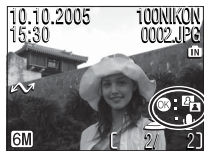

1



Confirmation dialog displayed.

2



Highlight OK.

3

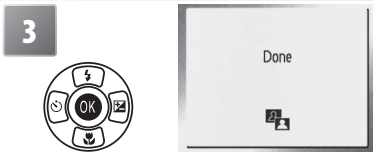

Done

Create copy.

During playback, copies created with D-lighting are indicated by a  icon.



D-Lighting

Copies created with D-lighting may not display or transfer correctly when viewed on other models of Nikon camera. See the Appendix for more information on D-lighting copies (▶ 69).

Voice Memos: Recording and Playback

The built-in microphone (🔊 2) can be used to record voice memos for pictures marked with a 🗣️ icon in full-frame playback (🔍 26).

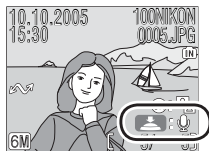

Recording Voice Memos

To record a voice memo, press and hold the shutter-release button. Recording ends after about 20 seconds or when the button is released. Do not touch the microphone during recording. Note that if a voice memo already exists for the current picture, it must be deleted before a new voice memo can be recorded.

Playing Voice Memos

During playback, pictures to which a voice memo has been appended are indicated by a 🗣️ icon. Press the shutter-release button to start and stop playback. Volume is controlled by the zoom button. Press **W** to lower volume, **T** to increase.



Deleting Voice Memos

To delete the voice memo for the current picture, press the 🗑️ button. The dialog shown at right will be displayed; press the multi selector up or down to highlight an option and press the center to select.

- **No**: Exit without deleting the picture or voice memo.
- **Yes**: Delete both picture and voice memo.
- **[J]**: Delete voice memo only.

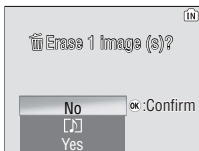

Voice Memos

Voice memos can not be added to pictures created with other types of camera. Voice memos recorded using other types of camera can not be played back on the COOLPIX L1/L101.

Movie Playback

In full-frame playback (📺 26), movies (📺 25) are indicated by a 📺 icon.

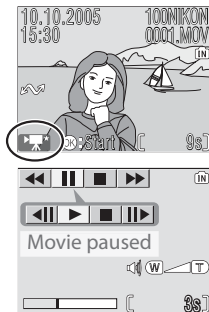

To play a movie, display it in full-frame playback and press the center of the multi selector. Playback controls appear at the top of the display; press the multi selector left or right to highlight a control, then press the center of the multi selector to perform the selected operation.

Control	Description
⏮	Movie rewinds while center of multi selector is pressed.
⏭	Movie advances while center of multi selector is pressed.
⏸	Pause playback.
⏪	Advance paused movie one frame.
⏩	Rewind paused movie one frame.
▶	Resume playback.
■	End movie and return to full-frame playback.

Volume is controlled by the zoom button. Press **W** to lower volume, **T** to increase.

Connecting to Televisions, Computers, and Printers

In addition to viewing pictures on the camera, you can also:

- View pictures on TV and record movies to video (see below)
- Copy pictures to a computer for storage and editing (📄 31–33)
- Print pictures on a home printer (🖨️ 34) or order prints from photofinisher

Before connecting the camera to another device, it may be necessary to change the **Interface** settings in the setup menu (🔍 41). See “Menus” (🔍 39–40) for more information. To prevent the camera from turning off unexpectedly during connection, use fresh batteries or an optional EH-62B AC adapter kit.

Viewing Pictures on TV

- 1 The **Interface > Video Mode** item in the setup menu offers a choice of NTSC and PAL standards for analog video output (🔍 46). Select a standard to match the television.



- 2 Turn the camera off and connect the A/V cable. Connect the black plug to the camera, the yellow plug to the video-in jack on the TV, and the white plug to the audio-in jack.

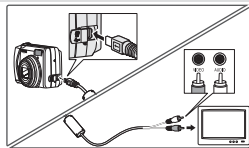

- 3 Tune the television to the video channel. If in doubt, consult the documentation for the TV.
- 4 Press the  button for about two seconds to turn the camera on. The camera monitor will remain off and the television will show the image normally shown in the monitor.

Viewing Pictures on a Computer

Before pictures can be transferred (copied) to a computer, PictureProject must be installed. For more information on installing and using PictureProject, see reference CD and *Quick Start Guide*. To transfer pictures to a computer:

- 1 Start a computer to which PictureProject has been installed.

- 2 Choose an **Interface > USB** option as described in “Choosing a USB Option for Connection to a Computer” (👁 33).



- 3 Turn the camera off and connect the USB cable as shown at right.

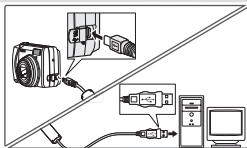

- 4 Turn the camera on.



- 5 Press the center of the multi selector to copy all marked pictures to the computer. The following messages will be displayed:

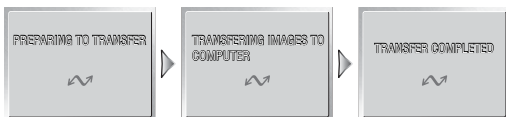

- 6 The pictures will be displayed in PictureProject when transfer is complete. Disconnect the camera as described in “Disconnecting the Camera” (👁 33).

Marking Pictures for Transfer

Pictures marked for transfer are shown by a  icon during playback. By default, all pictures are automatically marked for transfer. Two options control transfer marking:

- **Interface > Auto Transfer** (setup menu): Choose **On** to mark all new pictures for transfer (👁 46).
- **Transfer Marking** (playback menu): Change marking for existing pictures (👁 55).



The PictureProject Transfer Button

To copy both marked and unmarked pictures to the computer, click the PictureProject **Transfer** button instead of pressing the center of the multi selector in Step 5.



Choosing a USB Option for Connection to a Computer

Consult the following table when choosing a USB option for connection to a computer (32). The default option is **Mass Storage**. For more information on menu operations, see “Menu” (39–40).

Computer operating system	Pictures transferred using:	
	Camera button	PictureProject Transfer button
Windows XP Home Edition Windows XP Professional	Choose Mass Storage or PTP .	
Windows 2000 Professional Windows Millennium Edition (Me) Windows 98 Second Edition (SE)	Choose Mass Storage .*	
Mac OS X 10.1.5 or later	Choose PTP .	Choose Mass Storage or PTP .

* Do NOT select **PTP**. If **PTP** is selected when the camera is connected, wait until the Windows hardware wizard is displayed, then click **Cancel** and disconnect the camera. Select **Mass Storage** in the camera **USB** menu before reconnecting the camera.

Disconnecting the Camera

If **PTP** is selected for **USB**, turn the camera off and disconnect the USB cable.

If **Mass Storage** is selected for **USB**, remove the camera from the system as described below before turning the camera off and disconnecting the USB cable.

• **Windows XP Home Edition/Windows XP Professional:**

Click the “Safely Remove Hardware” icon (🗑️) in the taskbar and select **Safely remove USB Mass Storage Device** from the menu that appears.



• **Windows 2000 Professional:** Click the “Unplug or Eject Hardware” icon (🗑️) in the taskbar and select **Stop USB Mass Storage Device** from the menu that appears.



• **Windows Millennium Edition (Me):** Click the “Unplug or Eject Hardware” icon (🗑️) in the taskbar and select **Stop USB Disk** from the menu that appears.



• **Windows 98 Second Edition (SE):** In My Computer, right click on the removable disk corresponding to the camera and select **Eject** from the menu that appears.



• **Macintosh:** Drag the untitled camera volume (“NO NAME”) into the Trash.



Printing Pictures

Users of PictBridge-compatible printers can connect the camera directly to the printer and print pictures without using a computer.

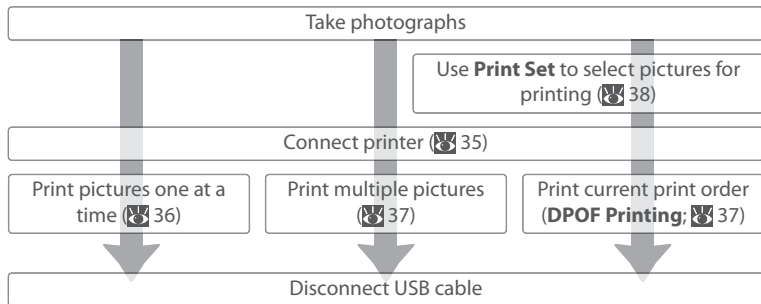

Other Ways to Print Pictures

Pictures can also be printed by:

- **Inserting a memory card in the printer:** If the printer is equipped with a card slot, a memory card can be inserted in the printer and pictures printed directly from the card. If the printer supports DPOF, the camera **Print Set** option can be used to select pictures for printing (38). See the printer manual for details.
- **Taking memory cards to a digital print service:** If the service supports DPOF, the camera **Print Set** option can be used to select pictures for printing (38).
- **Transferring pictures to a computer:** Once transferred to a computer (31–32), pictures can be printed using imaging software. See the application and printer manuals for details.

Printing the Date of Recording on Pictures

Two options are available for printing the date of recording on pictures: **Date Imprint** (44) and **Print Set > Date** (38).

Date Imprint	Print Set > Date
Must be set before picture is taken	Set after picture is taken
Date permanently imprinted on picture	Date stored separately
Date appears whenever picture is printed.	Date only appears when picture is printed on DPOF-compatible printer

The date only appears once; **Print Set > Date** can not be used to print two dates on pictures with a date imprint.

Connecting the Printer

1 Turn the printer on.

2 Set the **Interface > USB** option in the setup menu to **PTP** (P 46). See “Menus” (P 39–40) for more information on menu operations.



3 Turn the camera off and connect the USB cable as shown at right.

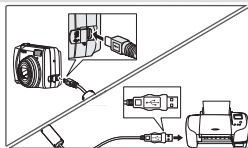

4 Turn the camera on. A PictBridge start-up screen will be displayed. The camera will then enter full-frame playback with the PictBridge logo displayed in the monitor.



Printing Pictures One at a Time

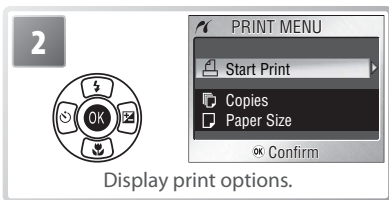
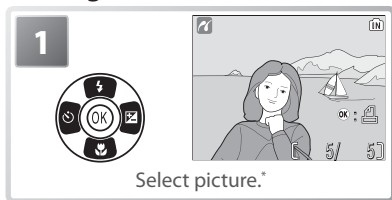

* To choose picture from thumbnail list, press **W** (🏠) and use multi selector to highlight desired picture, or press **T** (🔍) to exit to full-frame playback.



3 Press multi selector up or down to highlight option, press center to select:

Option	Description
Start Print	Start printing. To cancel before all copies have been printed, press center of multi selector. Camera returns to PictBridge playback display when printing is complete; repeat from Step 1 to print additional pictures.
Copies	Press multi selector up or down to choose number of copies (up to 9). Press center of multi selector to return to previous menu.
Paper Size	Press multi selector up or down to highlight desired page size. Press center of multi selector to return to previous menu.

COPIES

1

OK Confirm

PAPER SIZE 1/2

Default

3.5" x 5"

5 x 7"

Postcard

100mm x 150mm

OK Confirm

Paper Size

The camera supports the following page sizes: **Default** (the default page size for the current printer), **3.5"x5"**, **5"x7"**, **Postcard**, **100mmx150mm**, **4"x6"**, **8"x10"**, **Letter**, **A3**, and **A4**. Only sizes supported by the current printer will be displayed.

Printing Multiple Pictures

To print multiple pictures, press the **MENU** button while the PictBridge playback screen is displayed (35). The menu shown at right will be displayed; press the multi selector up or down to highlight an option, then press the center to select.

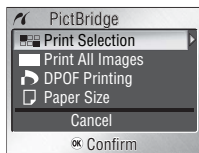

Option	Description
Print Selection	Print selected pictures (see below).
Print All Images	Print one copy of all images.
DPOF Printing	<p>Press multi selector up or down to highlight option, press center to select:</p> <ul style="list-style-type: none"> • Start Print: Print current print order (38). • Confirm: View print order. Press center of multi selector to start printing, or press MENU to exit. • Cancel: Exit without printing.
Paper Size	Choose page size (36).



Printing Selected Pictures

Choosing **Print Selection** displays the menu shown in Step 1.

1

Scroll through pictures. Current picture shown at center of display.

2

Select current picture and set number of prints to 1. Selected pictures marked by icon.

3

Choose number of prints (up to 9). To deselect picture, press multi selector down when number of prints is 1. Repeat steps 1–2 to select additional pictures.

4



Confirm selection (to return to step 1 and change selection, press **MENU** button).

5

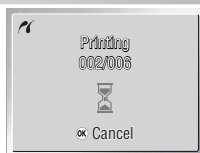

Start printing. PictBridge menu is displayed when printing is complete.*

* Press center of multi selector again to cancel before printing is complete.

Creating a DPOF Print Order: Print Set

The **Print Set** option in the playback menu (⏮ 54) is used to create digital "print orders" for printing on DPOF-compatible devices (⏮ 66). Selecting **Print Set** displays the menu shown in Step 1.

1

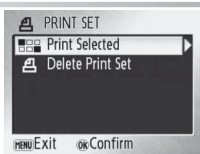

Highlight **Print Selected**.

2

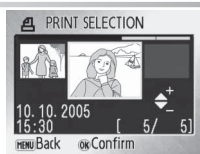

Display selection dialog.

* To delete current print order, highlight **Delete Print Set** and press center of multi selector.

3

Select pictures as described in Steps 1–4 of "Printing Selected Pictures" (⏮ 37–38).

4



Press multi selector up or down to highlight option, press center to select.







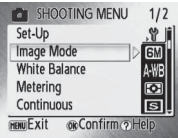
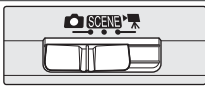
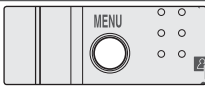

- **Date:** Print date of recording on all pictures in print order.
- **Info:** Print shutter speed and aperture on all pictures in print order.
- **Done:** Complete print order and exit.

Print Set

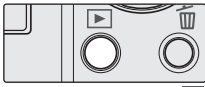
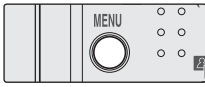
Date and **Info** are reset each time the menu shown Step 4 is displayed. **Info** is not printed when the camera is connected directly to the printer.

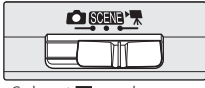
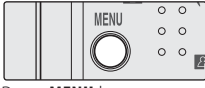
Menus

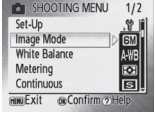
Menus are available for shooting, playback, movies, and camera setup. Press the **MENU** button to display the menus; press again to return to shooting or playback.

To display the shooting menu:		
1 	2 	
Select  mode.	Press MENU button.	
To display the playback menu:		
1 	2 	
Display picture full frame ( 26).	Press MENU button.	
To display the movie menu:		
1 	2 	
Select  mode.	Press MENU button.	
To display the setup menu:		
1 	2 	
Display scene ( 17), shooting, playback, or movie menu.	Highlight SET-UP and press center of multi selector.	

Menus

Use the multi selector to navigate the menus:

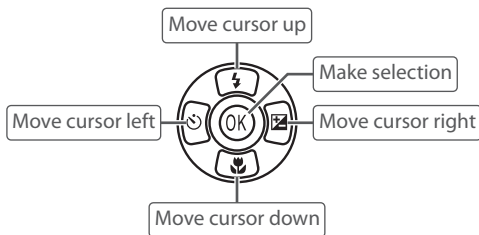

Default Settings

See the Appendix for information on menu defaults ( 66).

To make a selection from a menu:

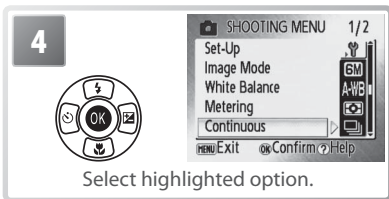
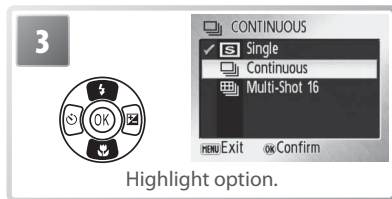
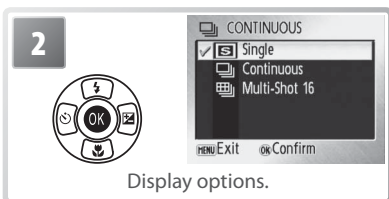
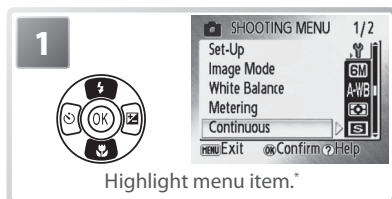

To select multiple pictures in the **Print Set** (38), **Erase Selected Images** (55), **Protect** (55), **Transfer Marking > Select Image(s)** (55), or **Copy > Selected Images** (56) menus:

Menus

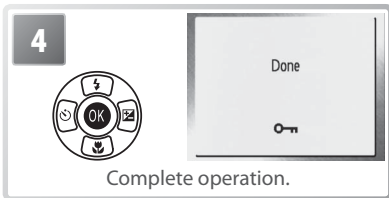
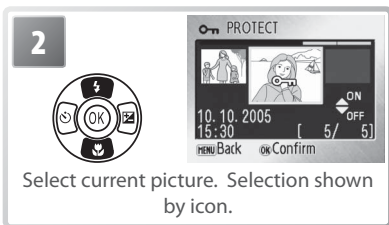
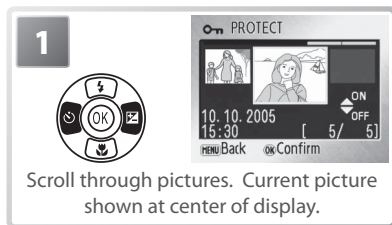

Help

For help on the highlighted item, press the **T** (?) button. Press **OK** to display the options for the highlighted item, **T** (?) to exit, or **MENU** to return to shooting or playback.

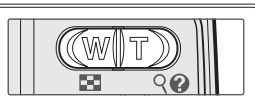

Basic Camera Setup: The Setup Menu

The setup menu contains the following options:



Option	Description	
Welcome Screen	Select screen displayed when camera is turned on.	41
Date	Set clock and choose home and destination time zones.	42
Monitor Settings	Adjust monitor brightness and choose display style.	43
Date Imprint	Imprint date or birthday counter on pictures.	44
Sound Settings	Adjust sound and volume settings.	45
Blur Warning	Turn blur warning on or off.	45
Auto Off	Choose when monitor will turn off to save power.	45
Format Memory/ Format Card	Format internal memory or memory card.	46
Language	Choose language for camera menus and messages.	46
Interface	Adjust settings for connection to television or computer.	46
Reset All	Restore camera settings to default values.	47
Battery Type	Choose type of battery inserted in camera.	47
Menus	Choose how menus are displayed.	47
Ver. Firmware Version	Display camera firmware version.	47

Welcome Screen

Choose the welcome screen displayed when the camera is turned on. To select a picture from internal memory or the memory card to use as a welcome screen, choose **Select an Image** (the image used in the welcome screen is a copy of the selected image and does not change when the original is deleted or the memory card is removed).







Default Settings

See the Appendix for information on setup menu defaults (66).

Date

Set the camera clock and to choose home and travel destination time zones.



Option	Description
Date	Set camera clock to current date and time ( 7–8).
Time Zone	Choose home () or travel destination () time zone ( 69); turn daylight saving time on or off.



To switch between home () and travel destination () time zones:

1



Highlight  or .

2



Set clock to time in selected zone. Dot marks current selection.*

* To change home or travel destination time zone, highlight and press multi selector right. Choose a time zone and daylight saving time as described in "Basic Setup" ( 7–8).

The Clock Battery

The clock battery charges when the main battery is installed or an AC adapter is connected, and can provide several days of backup power after about 10 hours of charging.

Monitor Settings

The following options are available:

Option	Description
Photo Info	Choose information displayed in monitor.
Brightness	Choose from five settings for monitor brightness.







Photo Info

The following display options are available:

Option	Description	Display	
		Shooting mode	Playback mode
Show Info	Indicators are displayed in monitor (4–5).		
Auto Info	Indicators are displayed for 5 s.		
Hide Info	Indicators are not displayed in monitor.		
Framing Grid	Indicators are displayed in monitor. In mode, framing grid is displayed to help frame pictures; other indicators are displayed for 5 s.		

DATE Date Imprint

Imprint date information on pictures as they are taken.

Option	Description
 Off	Time and date do not appear on pictures.
 Date	Date or date and time are imprinted on pictures taken while this option is in effect.
 Date and Time	Time stamp shows number of days between date of shooting and selected date (see below).
 1 Date Counter	



At settings other than **Off**, the option selected is indicated by an icon in the monitor during shooting.



1 Date Counter

Pictures taken while this option is in effect are imprinted with the number of days remaining until or the number of days elapsed since a specified date. Use it to track the growth of a child or count down the days until a birthday or wedding.

Press multi selector right to view stored dates

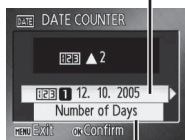

Press multi selector right to view display options

Stored dates

Up to three dates can be stored. To set, highlight, press multi selector to right, and enter date (→ 7–8). To select, highlight and press center of multi selector.

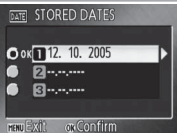

Display options

Highlight **Number of Days, Years and Days, or Yrs, Mnths, Days** and press center of multi selector.

Sample date counter time stamps are shown below.



Future date (days remaining)



Past date (days elapsed)

Date Imprint

The date is recorded in the order selected in the DATE menu (→ 42). Date imprint can not be used to print date information on existing pictures. See “Creating a DPOF Print Order: Print Set” (→ 38) for a comparison of date imprint and **Print Set > Date**.

Data imprinted at an **Image Mode** setting of **TV Screen (640)** may be difficult to read. Choose **PC Screen (1024)** or larger when using date imprint.

Sound Settings

Adjust the following sound settings:

Option	Description
Button Sound	When On is selected, beep will sound once when operations are completed successfully, three times when error is detected.
Shutter Sound	Choose volume of shutter sound.
Start-Up Sound	Choose volume of sound that plays when camera is turned on.

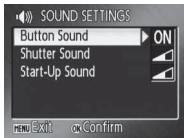

Blur Warning

Choose whether or not the blur warning is displayed (64). Note that the warning may not always be displayed (64).



Auto Off

Choose the time before the monitor turns off automatically to save power (10).

Option	Description
Auto Off	Choose delay before monitor turns off when no operations are performed.
Sleep Mode	If On is selected, monitor will turn off if no change is detected in brightness of subject for 30s (Auto Off set to 1 min. or less) or 1 min. (Auto Off set to 5 min. or more).

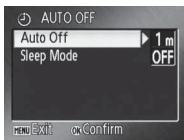

Regardless of the option selected, the monitor will remain on for a minimum of three minutes when menus are displayed, and for thirty minutes during a slide show or when the camera is powered by an optional EH-62B AC adapter.

Format Memory / Format Card

If no memory card is inserted, this option is named **Format Memory** and formats internal memory. Otherwise it is named **Format Card** and formats the memory card for use in the camera. *Note that formatting permanently deletes all pictures and other data.* Be sure to make copies as required before formatting.

Two format options are available when a memory card is inserted: **Quick Format** (formats only areas of the card on which data are stored) and **Format** (formats entire card). **Format** is not available when batteries are low.

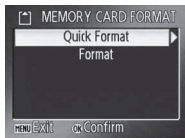

Format

Do not turn the camera off or remove the batteries or memory card during formatting. Use the **Format** option to format memory cards before first use and reformat them regularly thereafter. Without regular formatting, performance will drop with use.

Language





Choose a language for camera menus and messages from the following options:

Deutsch	German	Русский	Russian
English	English	Svenska	Swedish
Español	Spanish	日本語	Japanese
Français	French	中文(简体)	Simplified Chinese
Italiano	Italian	中文(繁體)	Traditional Chinese
Nederlands	Dutch	한글	Korean



Interface

Adjust settings for connection to a computer or video device.

Option	Description
USB	Select USB option for connection to computer ( 33) or printer ( 35).
Video Mode	Choose from NTSC and PAL ( 31).
Auto Transfer	Choose On to mark all new pictures for transfer to computer ( 32).



C Reset all

Select **Reset** to restore camera settings to their default values (66).



B Battery Type

To ensure that the camera shows the correct battery level (10), choose a type that matches the batteries currently in use.

Option	Battery Type
Alkaline	Alkaline
COOLPIX (NiMH)	EN-MH1-B2, oxy-nickel
Lithium	Lithium



MENU Menus

Choose how menus are displayed.



Text



Icon





Ver. Firmware Version











View the current camera firmware version.



Shooting Options: The Shooting Menu

With the exception of **Image mode**, the following options are available only in  mode. See “Menus” for information on viewing and using the shooting menu ( 39–40).







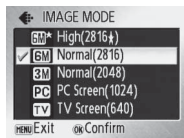

Option	Description	
 SET-UP	Display the setup menu.	41
 Image Mode	Choose image size and quality.	48
 White Balance	Match white balance to the light source.	49
 Metering	Choose how the camera sets exposure.	50
 Continuous	Take pictures one at a time or in a sequence.	51
 BSS	Use BSS to choose the sharpest picture.	51
 Color Options	Control color.	52
 AF Area Mode	Choose how the camera focuses.	52
 Autofocus Mode		52

* See the Appendix for information on restrictions that may apply to these settings ( 68).

Image Mode

Pictures taken with a digital camera are recorded as image files. The size of the files, and with it the number of images that can be recorded ( 67), depends on the *size* and *quality* of the images (image mode). Before shooting, choose an image mode according to how you plan to use the picture.



Option	Size (pixels)	Description
 High (2816*)	2,816 × 2,112	Pictures are compressed less than Normal , producing higher quality images.
 Normal (2816)	2,816 × 2,112	Best choice in most situations.
 Normal (2048)	2,048 × 1,536	Smaller size allows more pictures to be stored.
 PC Screen (1024)	1,024 × 768	Suited to computer display.
 TV Screen (640)	640 × 480	Suited to e-mail or television viewing.

The current setting is shown by an icon in the display.

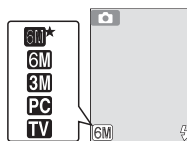





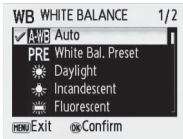

Shooting Menu Settings

See the Appendix for information on shooting menu defaults ( 66).

WB White Balance

Process pictures to produce natural colors under different types of light.



Option	Description
A-WB Auto	White balance automatically adjusted to suit lighting conditions. Best choice in most situations.
PRE White Bal. Preset	Neutral-colored object used as reference to set white balance under unusual lighting conditions (see below).
 Daylight	White balance adjusted for direct sunlight.
 Incandescent	Use under incandescent lighting.
 Fluorescent	Use under most types of fluorescent lighting.
 Cloudy	Use when taking pictures under overcast skies.
 Flash	Use with the flash.

At settings other than **Auto**, the current setting is shown by an icon in the display.

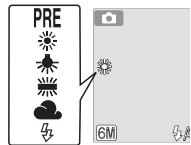

PRE Preset White Balance

Preset white balance is used with mixed lighting or to compensate for light sources with a strong color cast (for example, to make pictures taken under a lamp with a red shade look as though they had been taken under white light).

1 Place white or gray reference object under lighting that will be used during shooting.

2



Highlight **White Bal.Preset**.



3



Camera zooms in.

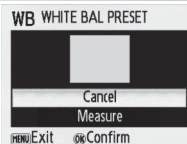

Preset White Balance

Preset white balance can not be measured with the flash.

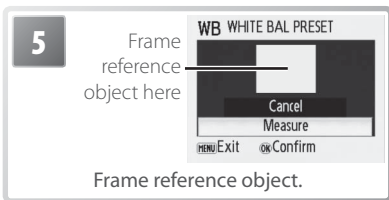
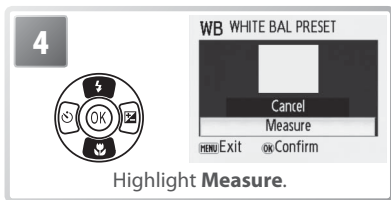

* To restore most recent value for preset white balance, highlight **Cancel** and press center of multi selector.

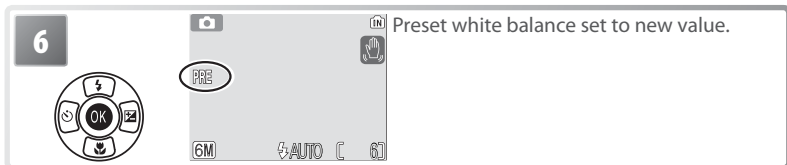

Metering

Choose how the camera sets exposure.





Option	Description
Matrix	Camera analyzes distribution of brightness over wide area of frame, producing optimal results in most situations.
Center-Weighted	Camera meters entire of frame but assigns greatest weight to center area. Classic meter for portraits.



Continuous

Capture a fleeting expression on a portrait subject, photograph a subject that is moving unpredictably, or capture motion in a series of pictures.



Option	Description
 Single	One shot is taken each time shutter-release button is pressed.
 Continuous	While shutter-release button is pressed, camera takes pictures at up to 0.7 frames per second (fps).
 Multi-Shot 16	Each time shutter-release button is pressed, camera takes 16 shots at about 3fps and arranges them in a single picture as shown at right. Image mode set to  Normal (2816) .



At settings other than **Single**, focus, exposure, and white balance are fixed at the values for the first picture in each series and the current setting is shown by an icon in the display.

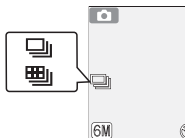

BSS

The “best shot selector” (BSS) is recommended when shooting with the flash off or the camera zoomed in, or in other situations in which inadvertent motion can result in blurred pictures. When BSS is on, the camera takes up to ten pictures while the shutter-release button is pressed. The sharpest picture in the series is saved and the others are discarded.

A **BSS** icon is displayed when BSS is on.

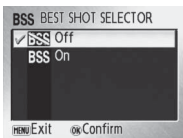





BSS

BSS may not produce the desired results if the subject moves or the composition is changed during shooting.

Color Options

Make colors more vivid or record pictures in monochrome.

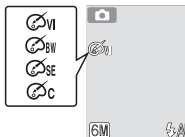

Option	Description
 Standard Color	Natural color.
 Vivid Color	Vivid, “photoprint” colors.
 Black-and-White	Take pictures in black-and-white.
 Sepia	Record pictures in sepia.
 Cyanotype	Take pictures in blue-tinted monochrome.

The effects of the selected option can be previewed in the monitor. At settings other than **Standard Color**, the current setting is also indicated by an icon in the display.



AF-Area Mode

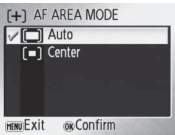

Choose where the camera focuses.

Option	Description
 Auto	Camera selects focus area (4–5, 12) containing subject closest to camera.
 Center	Camera focuses on subject at center of frame.



Autofocus Mode

Choose how the camera focuses.

Option	Description
 Single AF	Camera focuses when shutter-release button is pressed halfway.
 Continuous AF	Camera adjusts focus constantly, even when shutter-release button is not pressed.

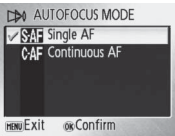

Focus Lock

With **AF-Area Mode** set to **Center** and **Single AF** selected for **Autofocus Mode**, focus lock can be used to focus on off-center subjects:

1



Position subject in center of frame.

2

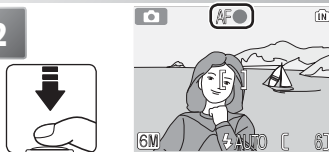

Press shutter-release button halfway and check focus.

3



Recompose picture with shutter-release button pressed halfway.

4



Take picture.

Playback Options: The Playback Menu

The playback menu contains the following options. See “Menus” for information on viewing and using the playback menu (📖 39–40).

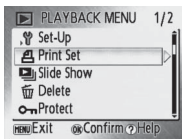

Option	Description	
SET-UP	Display the setup menu.	41
Print Set	Select pictures for printing.	38
Slide Show	View pictures in an automatic slide show.	54–55
Delete	Delete all or selected pictures.	55
Protect	Protect selected pictures from accidental deletion.	55
Transfer Marking	Change transfer marking for existing pictures.	55
Small Pic.	Create a small copy of the current picture.	56
Copy	Copy files between memory card and internal memory.	56

Print Set

Create digital “print orders” for PictBridge printers and devices that support DPOF (📖 38).

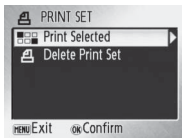

Slide Show

Play pictures back in an automated “slide show,” with about three seconds between each picture.



1

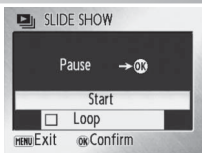

Highlight **Start**.

2



Begin slide show.

Movies

Movies appear in slide shows as still images of the first frame.

“Loop”

Select **Loop** to repeat the slide show until the center of the multi selector is pressed. Note that the monitor will turn off automatically if no operations are performed for 30 minutes.

To skip to the next picture, press the multi selector to the right, or press the multi selector to the left to return to the previous picture. Hold the multi selector down to fast forward or rewind. To pause the slide show, press the center of the multi selector. The menu shown below will be displayed.

When the slide show ends or is paused, the menu shown at right will be displayed. Highlight **Restart** and press the center of the multi selector to restart the show, or select **End** to end the show and return to the playback menu.

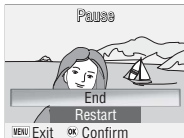



Delete

Delete all or selected pictures. Note that pictures marked with a  icon are protected and can not be deleted.



Protect



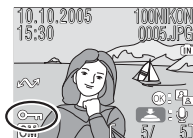
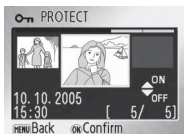

Protect selected pictures from accidental deletion. Protected pictures are marked with a  icon (see right, below) and can not be deleted using the  button or the **Delete** option in the playback menu. Note, however, that formatting *will* delete protected files ( 46).



Transfer Marking

Mark existing pictures for transfer to a computer (to mark new pictures for transfer, use the **Interface > Auto Transfer** option in the setup menu;  46).





Option	Description
 All On	Mark all images for transfer.
 All Off	Remove transfer marking from all images.
 Select Image(s)	Mark selected pictures for transfer ( 40).

Pictures selected for transfer are identified by a  icon.





Small Pic.

Create a small copy of the current picture. Choose from the following sizes:

Option	Description
 640 x 480	Suited to television playback.
 320 x 240	Suited to display on web pages.
 160 x 120	Suitable for e-mail.

A confirmation dialog will be displayed. Highlight **Yes** and press the center of the multi selector to create a copy at the chosen size.





During playback, small copies are indicated by a gray border; a , , or  icon is displayed when copies are viewed full-frame.

Small Picture

Small copies are compressed for reduced file size and may not display or transfer correctly when viewed on other models of Nikon camera. See the Appendix for more information on small copies ( 69).

Copy

Copy pictures between internal memory and a memory card.

Option	Description
 	Copy pictures from internal memory to memory card.
 	Copy pictures from memory card to internal memory.

Selecting either of the above options displays the menu shown at right. Choose **Selected Images** to select the pictures that will be copied ( 40) or **All Images** to copy all pictures.

A confirmation dialog will be displayed. Highlight **Yes** and press the center of the multi selector to copy the images.

Copy

The camera may be unable to copy pictures that were created with another make of camera or that have been modified on a computer. See pages 68–69 for more information on how copies are stored.

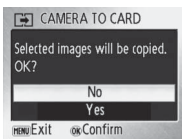
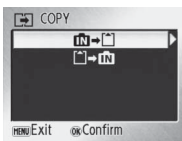
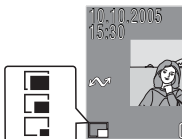

Movie Options: The Movie Menu

The movie menu contains the options shown at right. See “Menus” for information on viewing and using the movie menu (📺 39–40).

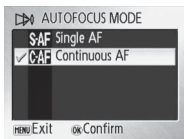
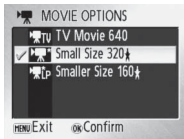

📺 Movie Options

Movies can be recorded at the following sizes:

Option	Size (pixels)	Frames per second
📺 TV TV Movie 640	640×480	15
📺* Small Size 320*	320×240	30
📺†P Smaller Size 160*	160×120	30

📺 Autofocus Mode

Choose how the camera focuses in movie mode.

Option	Description
S-AF Single AF	Camera focuses when shutter-release button is pressed halfway and locks at this position during shooting, preventing sound of camera focusing from interfering with recording.
C-AF Continuous AF	Camera constantly adjusts focus, even when shutter-release button is not pressed.

📺 Movies

See the Appendix for information on movie menu defaults (📺 66) and on the maximum total length of movie that can be recorded at different settings (📺 67).

Technical Notes

Optional Accessories

At the time of writing, the following optional accessories were available for this camera. Contact your local retailer or Nikon representative for details.

Rechargeable battery	Rechargeable EN-MH1-B2 NiMH batteries
Battery charger	MH-71 battery charger
AC adapter	EH-62B AC adapter kit (connects as shown)

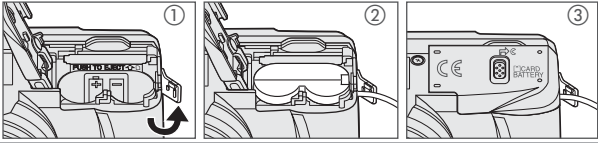

Approved Memory Cards

The following cards have been tested and approved for use with the COOLPIX L1/L101:

Panasonic	64 MB, 128 MB, 256 MB*, 512 MB*, 1 GB*
SanDisk	64 MB, 128 MB, 256 MB, 256 MB*, 512 MB, 512 MB*, 1 GB
Toshiba	64 MB, 128 MB, 128 MB*, 256 MB, 256 MB*, 512 MB

* High speed (10 MB/s)

Operation is not guaranteed with other makes of card. For more details on the above cards, please contact the manufacturer.

Memory Cards

- Use only Secure Digital (SD) memory cards.
- Format memory cards before first use (▶ 46).
- Do not eject the memory card, turn the camera off, remove the batteries, or disconnect the AC adapter during formatting or while data are being written to or deleted from the card. Failure to observe this precaution could result in loss of data or damage to the camera or card.
- Do not disassemble or modify.
- Do not drop, bend, or expose to water or strong physical shocks.
- Do not touch the metal terminals with your fingers or metal objects.
- Do not affix labels or stickers to the memory card.
- Do not leave in direct sunlight, closed vehicles, or areas exposed to high temperatures.
- Do not expose to high levels of humidity or to corrosive gas.

Caring for the Camera

To ensure continued enjoyment of this Nikon product, observe the following precautions when storing or using the device.

- ✔ **Handle the lens and all moving parts with care**
Do not apply force to the lens, monitor, or battery-chamber and lens covers. These parts are easily damaged. Force applied to the lens cover could cause malfunction or damage the lens. Should the monitor break, care should be taken to avoid injury due to broken glass and to prevent the liquid crystal from the display touching the skin or entering the eyes or mouth.
- ✔ **Do not point the lens at strong light sources for extended periods**
Avoid pointing the lens at the sun or other strong light sources for extended periods when using or storing the camera. Intense light may cause deterioration in the CCD image sensor, producing a white blur effect in photographs.
- ✔ **Turn the product off before removing or disconnecting the power source**
Do not unplug the product or remove the batteries while the product is on, or while images are being recorded or deleted. Forcibly cutting power in these circumstances could result in loss of data or in damage to product memory or internal circuitry. To prevent an accidental interruption of power, avoid carrying the product from one place to another while an AC adapter is connected.
- ✔ **Keep dry**
The device will be damaged if immersed in water or subjected to high levels of moisture.
- ✔ **Do not drop**
The product may malfunction if subjected to strong shocks or vibration.
- ✔ **Keep away from strong magnetic fields**
Do not use or store this device in the vicinity of equipment that generates strong electromagnetic radiation or magnetic fields. Strong static charges or the magnetic fields produced by equipment such as radio transmitters could interfere with the monitor, damage data stored on the memory card, or affect the product's internal circuitry.
- ✔ **Avoid sudden changes in temperature**
Sudden changes in temperature, such as occur when entering or leaving a heated building on a cold day, can cause condensation inside the device. To prevent condensation, place the device in a carrying case or a plastic bag before exposing it to sudden changes in temperature.

Batteries

- Check the battery level when taking the camera out and replace the batteries if necessary (8/10). If possible, carry spare batteries when taking pictures on important occasions.
- Battery capacity tends to decrease on cold days. Be sure that the batteries are fresh before heading outside to take pictures in cold weather. Keep spare batteries in a warm place and exchange as necessary. Once warmed, a cold battery may recover some of its charge.
- Dirt on the battery terminals can prevent the camera from functioning.
- Used batteries are a valuable resource. Please recycle used batteries in accordance with local regulations.

Cleaning

Lens	Avoid touching glass parts with your fingers. Remove dust or lint with a <i>blower</i> (typically a small device with a rubber bulb attached to one end that is pumped to produce a stream of air out the other). To remove fingerprints or other stains that can not be removed with a blower, wipe the lens with a soft cloth, using a spiral motion that starts in the center of the lens and works out to the edges. If this fails, clean the lens using a cloth lightly dampened with commercial lens cleaner.
Monitor	Remove dust or lint with a blower. To remove fingerprints and other stains, clean the monitor with a soft, dry cloth, being careful not to apply pressure.
Body	Use a blower to remove dust, dirt, or sand then wipe gently with a soft, dry cloth. After using the camera at the beach or seaside, wipe off any sand or salt with a dry cloth lightly dampened with fresh water, then dry thoroughly. Note that foreign matter inside the camera could cause damage not covered under warranty.

Do not use alcohol, thinner, or other volatile chemicals.

Storage

Turn the camera off when not in use. Check that the power-on lamp is off before putting the camera away and remove the batteries if the camera will not be used for an extended period. Do not store the camera with naphtha or camphor moth balls or in locations that:

- are next to equipment that produces strong electromagnetic fields, such as televisions or radios
- are exposed to temperatures below -10°C (14°F) or above 50°C (122°F)
- are poorly ventilated or subject to humidities of over 60%













To prevent mold or mildew, take the camera out of storage at least once a month. Turn the camera on and release the shutter a few times before putting the camera away again.





Notes on the Monitor

- The monitor may contain a few pixels that are always lit or that do not light. This is a characteristic common to all TFT LCD displays, and does not indicate a malfunction. Images recorded using the product will not be affected.
- When you frame bright subjects, vertical comet-like streaks that whiten toward either end may appear in the display. This phenomenon, known as “smear,” does not appear in the final photograph and does not indicate a malfunction. Some smear may appear in movies.
- Images in the monitor may be difficult to see in a bright light.
- The monitor is lit by an LED backlight. Should the monitor begin to dim or flicker, contact your Nikon service representative.

Error Messages



The following table lists the error messages and other warnings that appear in the monitor and how to deal with them.

Display	Problem	Solution	
 (blinks)	Clock not set.	Set clock.	42
	Batteries running low.	Ready spare batteries.	6–7
WARNING!! BATTERY EXHAUSTED	Batteries exhausted.	Replace batteries.	7, 47
AF  (blinks red)	Camera cannot focus.	Use focus lock to focus on another subject at same distance, then recompose picture.	12, 53
 (blinks)	Slow shutter speed. Pictures may be blurred.	Use flash, or steady camera using tripod, by placing camera on level surface, or by holding camera in both hands with elbows against torso.	11, 12, 14
WARNING!! Please wait for camera to finish recording 	Camera cannot perform other operations until recording is complete.	Message clears from display automatically when recording is complete.	—
MEMORY CARD IS WRITE PROTECTED	Write-protect switch is in “lock” position.	Slide write-protect to “write” position.	9
THIS CARD CANNOT BE USED 	Error accessing memory card.	<ul style="list-style-type: none"> • Use approved card. • Check that connectors are clean. • Confirm that memory card is correctly inserted. 	58
WARNING!! THIS CARD CANNOT BE READ 			9
CARD IS NOT FORMATTED  FORMAT NO	Memory card has not been formatted for use in camera.	Highlight FORMAT and press  to format card, or turn camera off and replace card.	9, 46
IMAGE CANNOT BE SAVED  or 	Error occurred while recording picture.	Format internal memory or memory card.	46
	Camera has run out of file numbers.	<ul style="list-style-type: none"> • Insert new memory card. • Format internal memory or memory card. 	9 46
	Cannot create cropped, D-lighting, or small copy.	Select picture that supports crop, D-lighting, or small picture.	69
	Picture cannot be used for welcome screen.	Choose picture 640 × 480 pixels or larger.	—
	Cannot copy picture.	Delete pictures from destination.	55

Display	Problem	Solution	
CANNOT RECORD MOVIE	Time out error while recording movie.	Choose memory card with faster write speed.	58
OUT OF MEMORY  or 	Memory card is full.	<ul style="list-style-type: none"> • Choose smaller image size. • Delete pictures. • Insert new memory card. • Remove memory card and use internal memory. 	48 55 9 9
CARD CONTAINS NO IMAGES	No pictures available for playback.	—	—
FILE CONTAINS NO IMAGE DATA	File not created with COOLPIX L1/L101.	View file on computer or other device.	—
ALL IMAGES ARE HIDDEN	No pictures available for display in welcome screen or slide show.	—	—
THIS IMAGE CANNOT BE DELETED	Picture is protected.	Remove protection.	55
NEW CITY IS IN THE CURRENT TIME ZONE	Destination in same time zone as home.	No need to change time zones if destination is in same time zone as home.	42
LENS ERROR	Lens error.	Turn camera off and then on again. If error persists, contact retailer or Nikon representative.	10
COMMUNICATIONS ERROR	USB cable disconnected during transfer or printing.	If PictureProject displays error, click OK to exit. Resume operation after turning camera off and reconnecting cable.	31–32
	USB option incorrect.	Choose correct USB option.	33
	PictureProject did not start.	See the PictureProject reference manual (on CD) for more information.	—
NO IMAGES ARE MARKED FOR TRANSFER	No pictures selected for transfer.	Select pictures for transfer and try again.	55
TRANSFER ERROR	Transfer error.	<ul style="list-style-type: none"> • Check battery level. • Check that USB cable is connected. 	10 32
SYSTEM ERROR	Error has occurred in camera's internal circuitry.	Turn camera off, remove and reinsert batteries, and turn camera on. If error persists, contact retailer or Nikon representative.	7, 10
PRINTER ERROR CHECK PRINTER STATUS	Printer error.	Check printer. To resume, highlight Resume (if available) and press  .	—

















Troubleshooting

If the camera fails to function as expected, check the list of common problems below before consulting your retailer or Nikon representative. Refer to the page numbers in the right-most column for more information.

Problem	Solution	
Camera turns off without warning	<ul style="list-style-type: none"> • Batteries are low. • Batteries are cold. 	10 60
Monitor is blank	<ul style="list-style-type: none"> • Camera is off. • Batteries are exhausted. • Standby mode: press shutter-release button halfway. • Flash lamp blinks: wait until flash has charged. • USB cable is connected. • A/V cable is connected. 	10 10 10, 45 14 32, 35 31
No indicators appear in monitor	Hide Info is selected for Photo Info . Select Show Info .	43
Monitor is hard to read	<ul style="list-style-type: none"> • Adjust monitor brightness. • Monitor is dirty: clean monitor. 	43 60
Camera clock is not correct	Check camera clock regularly against more accurate timepieces and reset as required.	42
Camera settings reset	Clock battery exhausted: recharge clock battery. Pictures recorded before clock has been set will have time stamp of "00.00.0000 00:00"; movies will be dated "01.01.2005 00:00."	42
No picture taken when shutter-release button is pressed	<ul style="list-style-type: none"> • Camera is in playback mode: press  button. • Menus are displayed: press MENU button. • Batteries are exhausted. • Flash lamp blinks: flash is charging. 	26 39 10 14
Camera can not focus using autofocus	<ul style="list-style-type: none"> • Subject is low in contrast, dominated by repeating geometric patterns, covers too small an area of the frame, or contains many fine details, objects of sharply differing brightness, or objects at different distances from the camera. Use focus lock to focus on another subject at same distance. • Focus error. Turn camera off and then on again. 	53 10

Electronically Controlled Cameras

In extremely rare instances, unusual characters may appear in the monitor and the camera may stop functioning. In most cases, this phenomenon is caused by a strong external static charge. Turn the camera off, remove and replace the batteries, and then turn the camera on again. In the event of continued malfunction, contact your retailer or Nikon representative. Note that disconnecting the power source as described above may result in the loss of any data not recorded to internal memory or the memory card at the time the problem occurred. Data already recorded will not be affected.

Problem	Solution	
Pictures are blurred	<ul style="list-style-type: none"> • Use flash. • Use BSS. • Use tripod and self-timer. 	14 51 15
Pictures are too dark (underexposed)	<ul style="list-style-type: none"> • Flash is off. • Flash window is blocked. • Subject is outside range of flash. • Exposure compensation is too low. • Subject is backlit: select  (scene mode) or use fill flash. 	14 11 14 16 14, 23
Pictures are too bright (overexposed)	Exposure compensation is too high.	16
Randomly-spaced bright pixels (“noise”) appear in image	Shutter speed too slow. Noise can be reduced by: <ul style="list-style-type: none"> • Using flash • Choosing         or  in scene mode 	14 19–23
Pictures are smeared	Lens is dirty. Clean lens.	60
Colors are unnatural	White balance does not match light source.	49
Flash does not fire	Flash is off. Note that flash turns off automatically in  mode and some scene modes or when option other than Single is selected for Continuous or BSS is on.	14, 51, 67
Bright specks in pictures taken with flash	Flash is reflecting from particles in air. Turn flash off.	14
Blur warning is not displayed	Blur warning is not displayed in self-timer mode or when  ,  or  is selected in scene mode, option other than Single is selected for Continuous , or BSS is on.	15, 21, 23, 51
No sound when shutter is released	Off selected for Sound Settings > Shutter Sound .	45
Optical zoom cannot be used	Optical zoom cannot be used while shooting movies.	25
Digital zoom cannot be used	Digital zoom is not available in  or framing assist modes or when option other than Single is selected for Continuous .	17, 25, 51
Image Mode not available	Image Mode cannot be adjusted when Multi Shot 16 is selected for Continuous or “Sports composite” is selected in scene mode.	21, 51
Metering not available	Metering cannot be changed when digital zoom is in effect.	11
Date Imprint not available	Camera clock has not been set.	42, 61
Date not appearing on pictures	Date does not appear on movies or on pictures taken using panorama assist.	23–24, 30
File cannot be played back	File has been overwritten or renamed by computer or other make of camera.	—





Problem	Solution	
Cannot zoom in on picture	Playback zoom cannot be used with movies, small pictures, or pictures that have been cropped to below 320 × 240.	—
Cannot record voice memo	Voice memos cannot be appended to movies.	—
Cannot use crop, D-lighting, or small picture options	These options cannot be used with movies and may not be available with pictures created with other cameras. Select picture that supports crop, D-lighting, or small picture.	69
Cannot mark pictures for transfer	No more than 999 pictures can be marked for transfer. Use PictureProject Transfer button to transfer pictures.	32
Transfer marking does not appear	Pictures were marked for transfer using another model of camera. Mark pictures for transfer using COOLPIX L1/L101.	—
PictureProject does not start when camera is connected	<ul style="list-style-type: none"> • Camera is off. • Batteries are exhausted. • USB cable is not correctly connected. • Appropriate USB option is not selected. • Camera is not registered in Device Manager (Windows only). See the PictureProject reference manual (on CD) for further information.	10 10 32 33 —
Pictures not displayed on television	Choose correct video mode.	31
Format Memory > Format option not available	Batteries are low.	10, 46

Appendix

Defaults (🔑 39, 41, 48, 57)

Choosing **Reset** for **Reset All** restores the following default settings:

Option	Default
mode	
Flash mode (🔑 14)	Auto
Self timer (🔑 15)	Off
Macro close-up (🔑 16)	Off
Exposure compensation (🔑 16)	0.0
Setup menu	
Welcome Screen (🔑 41)	Animation
Photo Info (🔑 43)	Show info
Brightness (🔑 43)	3
Date Imprint (🔑 44)	Off
Button Sound (🔑 45)	On
Shutter Sound (🔑 45)	Normal
Start-up Sound (🔑 45)	Normal
Blur Warning (🔑 45)	On
Auto Off (🔑 45)	1 min.
Sleep Mode (🔑 45)	On
Auto Transfer (🔑 46)	On
Menus (🔑 47)	Text

Option	Default
Scene mode	
	Portrait
Portrait assist (🔑 19)	
Landscape assist (🔑 19)	
Sports assist (🔑 21)	
Night portrait assist (🔑 21)	
Shooting menu	
Image Mode (🔑 48)	Normal (2816)
White Balance (🔑 49)	Auto
Metering (🔑 50)	Matrix
Continuous (🔑 51)	Single
BSS (🔑 51)	Off
Color Options (🔑 52)	Standard color
AF-Area Mode (🔑 52)	Auto
Autofocus Mode (🔑 52)	Single AF
Movie menu	
Movie Options (🔑 57)	Small size 320*
Autofocus Mode (🔑 57)	Continuous AF
PictBridge	
Paper Size (🔑 36, 37)	Default

Choosing **Reset** also clears the current file number (🔑 68) from memory. Numbering will continue from the lowest number available (to reset file numbering to 0001, delete all pictures before selecting **Reset**). All other settings are unaffected, including **Date** (🔑 42), **Date Counter** (🔑 44), **Language** (🔑 46), **USB** (🔑 46), **Video Mode** (🔑 46), and **Battery Type** (🔑 47).

Supported Standards

- **DCF:** Design Rule for Camera File System (DCF) is standard widely used in the digital camera industry to ensure compatibility among different makes of camera.
- **DPOF:** Digital Print Order Format (DPOF) is an industry-wide standard that allows pictures to be printed from print orders stored on the memory card.
- **Exif version 2.2:** This camera supports Exif (Exchangeable Image File Format for Digital Still Cameras) version 2.2, a standard that allows information stored with photographs to be used for optimal color reproduction when images are output on Exif-compliant printers.
- **PictBridge:** A standard developed by in cooperation with the digital camera and printer industries, allowing photographs to be output directly to a printer without connecting the camera to a computer.

Scene Mode Settings (📷 17)

The following table lists the default flash mode, self-timer, macro close-up, and exposure compensation settings for each scene. These settings are restored when the camera is turned off, 📷 or 📺 mode is selected, pictures are played back, or **Reset** is selected for **Reset All** in the setup menu. Settings in parentheses can be changed.

Mode	Flash mode (📷 14)	Self-timer (🕒 15)	Macro close-up (📷 16)	Exp. comp. (📷 16)
Portrait	⚡👁	(OFF)	OFF	(0.0)
Landscape	📷	(OFF)	OFF	(0.0)
Sports	📷	OFF	OFF	(0.0)
Night portrait	⚡👁	(OFF)	OFF	(0.0)
Party/Indoor	⚡👁	(OFF)	OFF	(0.0)
Beach/Snow	⚡ AUTO	(OFF)	(OFF)	(0.0)
Sunset	📷	(OFF)	OFF	(0.0)
Dusk/Dawn	📷	(OFF)	OFF	(0.0)
Night landscape	📷	(OFF)	OFF	(0.0)
Close up	(📷)	(OFF)	ON	(0.0)
Museum	📷	(OFF)	(OFF)	(0.0)
Fireworks show	📷	OFF	OFF	0.0
Copy	(📷)	(OFF)	(OFF)	(0.0)
Back light	⚡	(OFF)	OFF	(0.0)
Panorama assist	(📷)	(OFF)	(OFF)	(0.0)

* Default for **Portrait right** and **Portrait left** is ⚡ AUTO. Other modes can be selected.

Image Mode (📷 48) and Movie Options (📺 57)

The following table lists the number of pictures or maximum total movie length that can be stored in internal memory and on a 256MB memory card, together with the size of still pictures printed at 300 dpi.

Image mode/movie options	Internal memory (10 MB)	256 MB memory card	Print size (cm / in.)
📷* High (2816*)	3	80	24×18/9½×7
📷 Normal (2816)	6	160	24×18/9½×7
📷 Normal (2048)	12	300	17×13/7×5
📷 PC Screen (1024)	43	1030	9×7/3½×2½
📷 TV Screen (640)	90	2220	5×4/2×1½
📺 TV Movie 640	14 s	5 min. 40 s	—
📺 Small Size 320*	16 s	6 min. 30 s	—
📺 Smaller Size 160*	1 min. 2 s	25 min.	—

* All figures are approximate. Maximum total movie length and number of pictures that can be stored varies with make of memory card and, in the case of JPEG images, with the type of scene recorded. If memory remains for more than 9999 pictures, exposure count display will show 9999.

Restrictions on Camera Settings (📷 48)

Restrictions apply to the following settings in 📷 mode:

Flash mode	Flash turns off at Continuous settings other than Single or when BSS is on. Original mode is restored when Single is selected or BSS is turned off.
Self timer	If self-timer is on, only one shot will be taken when shutter is released, regardless of settings chosen for Continuous and BSS . Original Continuous and BSS settings are restored when picture is taken or self-timer is turned off.
Continuous	Selecting Continuous or Multi-Shot 16 turns BSS off. Original BSS setting is not restored when Single is selected.
BSS	Continuous is set to Single when BSS is on. Original setting is not restored when BSS is turned off.
White balance	White balance is set to Auto and can not be adjusted when Black-and-White , Sepia , or Cyanotype is selected for Color Options . Original white balance is restored when Standard Color or Vivid Color is selected.

Image File and Folder Names

Pictures, movies, and voice memos are assigned file names with three parts: a four letter identifier, a four-digit file number assigned automatically by the camera in ascending order, and a three-letter extension (e.g., "DSCN0001.JPG").

Originals	Identifier	Extension	Copies	Identifier	Extension
Still picture	DSCN	.JPG	Cropped copy	RSCN	.JPG
Movie	DSCN	.MOV	Small copy	SSCN	.JPG
Voice memo	Same as picture	.WAV	D-lighting copy	FSCN	.JPG

Pictures are stored in folders named with a three-digit folder number followed by a five-character identifier: "P_" plus a three-digit sequence number for pictures taken using panorama assist (e.g., "101P_001"; 📷 23–24) and "NIKON" for all other pictures (e.g., "100NIKON"). Folders can hold up to 200 pictures; if a picture is taken when the current folder contains 200 pictures, a new folder will be created by adding one to the current folder number. If a picture is taken when the current folder is numbered 999 and contains 200 pictures or a picture numbered 9999, no further pictures can be taken until the medium is formatted (📷 46) or a new memory card inserted.

Files copied using **Copy > Selected Images** are copied to the current folder, where they are assigned new file numbers in ascending order starting from the largest file number in memory. **Copy > All Images** copies all folders from the source device; file names do not change but new folder numbers are assigned in ascending order starting from the largest folder number on the destination device (📷 56).

Copies (🔍 27, 28, 56)

Copies created using crop (🔍 27), D-lighting (🔍 28), and small picture (🔍 56) have the same transfer marking as the original but are not marked for printing or protection. Copies created using **Copy** (🔍 56) have the same protection marking as the original but are not marked for printing or transfer. The crop and small picture options can not be used with copies created with crop or small picture; D-lighting is not available with copies created with D-lighting.

Time Zones (🔍 7–8, 42)

The camera supports the time zones listed below. Increments of less than one hour are not supported; when travelling to or from destinations at half- or quarter-hour increments from Greenwich Mean Time (GMT), such as Afghanistan, Central Australia, India, Iran, Nepal, or Newfoundland, set the camera clock to local time (🔍 7–8, 42).

GMT +/-	Location	GMT +/-	Location
-11	Midway, Samoa	+1	Madrid, Paris, Berlin
-10	Hawaii, Tahiti	+2	Athens, Helsinki
-9	Alaska, Anchorage	+3	Moscow, Nairobi
-8	PST (PDT): Los Angeles, Seattle, Vancouver	+4	Abu Dhabi, Dubai
-7	MST (MDT): Denver, Phoenix, La Paz	+5	Islamabad, Karachi
-6	CST (CDT): Chicago, Houston, Mexico City	+6	Colombo, Dhaka
-5	EST (EDT): New York, Toronto, Lima	+7	Bangkok, Jakarta
-4	Caracas, Manaus	+8	Beijing, Hong Kong (HK), Singapore
-3	Buenos Aires, São Paulo	+9	Tokyo, Seoul
-2	Fernando de Noronha	+10	Sydney, Guam
-1	Azores	+11	New Caledonia
±0	London, Casablanca	+12	Auckland, Fiji

Refreshing Nikon EN-MH1-B2 Rechargeable NiMH Batteries (🔍 6, 58)

An MH-71 battery charger and rechargeable EN-MH1-B2 NiMH batteries are provided with the camera in some regions and are also available as options (🔍 58). NiMH batteries may suffer a temporary drop in capacity if charged after long periods of disuse or before being fully discharged. They will return to normal after being refreshed a few times as described below.

- 1 Insert both batteries into the charger (🔍 6).
- 2 Press the REFRESH button until the REFRESH lamp lights and close the lid. The REFRESH lamp turns off when the batteries are fully discharged. The batteries can now be removed or left in the MH-71 to recharge (🔍 6). Unplug the charger after removing the batteries.

To resume charging before the batteries are fully discharged, or to refresh the batteries once charging has begun, press the REFRESH button for about two seconds.

Batteries that retain a charge for only short periods after being refreshed have reached the end of their working life and can no longer be used.

Specifications

Nikon COOLPIX L1/L101 Digital Camera

Type	Compact digital camera	
Effective pixels	6.2 million	
CCD	1½-s-in. CCD; total pixels: 6.37 million	
Image size (pixels)	<ul style="list-style-type: none"> • 2,816 × 2,112 (2816*, 2816) • 2,048 × 1,536 (2048) 	<ul style="list-style-type: none"> • 1,024 × 768 (1024) • 640 × 480 (640)
Lens	Zoom-Nikkor with 5 × optical zoom	
Focal length	F=6.3–31.4 mm (35-mm [135] camera-format equivalent: 38–190 mm)	
f/-number	f/2.9–f/5.0	
Construction	9 elements in 7 groups	
Digital zoom	Up to 4 × (35-mm [135] camera-format equivalent: 760 mm)	
Autofocus (AF)	Contrast-detect AF	
Focus range (from lens)	50 cm (1 ft. 8 in.)–∞	Macro mode: 4 cm (1.6 in.)–∞ (W)
Focus-area selection	Center; auto multi AF with 5 focus areas	
Monitor	2.5 in., 115,000-dot, TFT LCD monitor with brightness adjustment	
Approximate frame coverage	Shooting mode: 98% horizontal and 98% vertical Playback: 100% horizontal and 100% vertical	
Storage		
Media	Internal memory (approx.10MB); SD (Secure Digital) memory cards	
File system	DCF, Exif 2.2, and DPOF compliant	
File formats	Compressed: JPEG-baseline-compliant Movies: QuickTime Sound files: WAV	
Exposure		
Metering	Matrix, center-weighted	
Exposure control	Programmed auto exposure with exposure compensation (–2.0–+2.0 EV in steps of ½ EV)	
Range	W: +2.5–+16.0 EV	T: +4.0–+17.5 EV
Shutter	Mechanical and charge-coupled electronic shutter	
Speed	4–1/2000 s	
Aperture	Magnetically controlled	
Range	f/2.9 and f/4.9 (W)	
ISO sensitivity (Recommended Exposure Index)	Approximately equivalent to ISO 50 (auto gain to ISO 200)	
Self-timer	Approximately 10 seconds	
Built-in flash		
Range (approx.)	W: 0.5–3.5 m/1 ft. 8 in.–11 ft. 6 in.	T: 0.5–2 m/1 ft. 8 in.–6 ft. 7 in.
Sync method	Sensor flash system	

I/O terminals	Audio video out/digital IO (USB)
Interface	USB
Video output	Can be selected from NTSC and PAL
Supported languages	Chinese (Simplified and Traditional), Dutch, English, French, German, Italian, Japanese, Korean, Russian, Spanish, Swedish
Power sources	<ul style="list-style-type: none"> • Two AA alkaline, oxy-nickel, or lithium batteries • Two rechargeable EN-MH1-B2 NiMH batteries • EH-62B AC adapter kit
Battery life	Approximately 100 shots with alkaline, 400 shots with lithium, or 230 shots with EN-MH1-B2 batteries*
Approximate dimensions	89.5 × 60.5 × 47 mm/3.5 × 2.4 × 1.9 in. (W × H × D)
Approximate weight	180 g (6.3 oz.) without battery or memory card
Operating environment	
Temperature	0–+40 °C (+32–104 °F)
Humidity	Less than 85% (no condensation)

* Based on Camera and Imaging Products Association (CIPA) standard for measuring life of camera batteries. Measured at 25 °C (77 °F); zoom adjusted with each shot, flash fired with every other shot, image mode set to NORMAL.

Unless otherwise stated, all figures are for a camera with fully-charged EN-MH1-B2 batteries operated at an ambient temperature of 25 °C (77 °F).

MH-71 Battery Charger (Option; Supplied with Camera in Some Regions)	
Rated input	AC 100–240V, 0.11–0.065 A, 50/60 Hz
Charging output	DC 1.2V/2000 mA
Applicable batteries	Nikon EN-MH1-B2 rechargeable Ni-MH batteries
Discharge time	Approximately 5 hours
Charging time	Approximately 2.5 hours
Operating temperature	5–35 °C (+41–95 °F)
Approximate dimensions	70 × 79 × 30 mm/2.8 × 3.1 × 1.2 in. (W × H × D)
Length of cord	Approximately 1800 mm (70.9 in.)
Approximate weight	110 g (3.9 oz.), excluding power cable

Specifications

Nikon will not be held liable for any errors this manual may contain. The appearance of this product and its specifications are subject to change without notice.

EN-MH1-B2 NiMH Batteries

The capacity of NiMH batteries will drop if they are charged repeatedly without first being fully discharged. The batteries will return to normal once fully discharged. Note that NiMH batteries gradually lose their charge when not in use; refresh the batteries immediately before use.

Index

Symbols

- (auto) mode, 10–12
- (delete) button, 13, 26, 27, 29
- (movie) mode, 25
- (playback) button, 13, 26–30
- (scene) mode
- (wait) icon, 61

A

- Accessories, 58
- AE-L, 24
- AF , *see* Focus, indicator
- AF-area mode, 52
- Assist modes, 18–21
- Autofocus, *see* Focus
- Auto-focus mode**
 - movie menu, 57
 - shooting menu, 52
- Auto off**, 10, 45
- Auto transfer**, *see* **Interface**
- A/V cable, 31
- A/V-out connector, 3, 31

B

- Backlit subjects, 14, 23
- Batteries, 6–7, 47
- Battery level indicator, 10, 61
- Battery type**, 47
- Best Shot Selector, 23, 51
- Black-and-white, 52
- Blur, 12, 45, 61, 64
- Blur warning**, 45
- Brightness**, *see* **Monitor settings**
- BSS**, *see* Best Shot Selector
- Burst shooting, *see* **Continuous**;
Scene, Sports ()
- Button sound**, *see* **Sound settings**

C

- Clock, *see* **Date**
- Close-ups, 16, 23
- Color options**, 52, 68
- Computer, 31–33, 46
 - copying pictures to, 31–33
- Continuous**, 51
- Continuous AF, *see* Focus, mode

- Copies, 69. *See also* **Copy** (playback menu); Cropping pictures; D-lighting; **Small pic.**
- Copy** (playback menu), 56
- Cropping pictures, 27
- Cyanotype, 52

D

- Date**, 7–8, 42, 44
- Date and time, *see* **Date**
 - printing, 38, 44
- Date counter**, *see* **Date imprint**
- Date imprint**, 44
- Daylight saving time, *see* **Date**
- DCF, *see* Design rule for Camera File system
- Default settings, 66, 67
- Delete**, 55
- Deleting pictures, 13, 26, 55
 - in full-frame playback, 13, 26
 - selected pictures, 55
- Design rule for Camera File system, 66
- Digital Print Order Format, 37–38, 66
- Direct Print, *see* PictBridge
- D-lighting, 28
- DPOF, *see* Digital Print Order Format

E

- E-mail, 48
- Error messages, 61–62
- Exif 2.2, 66
- Exif Print, *see* Exif 2.2
- Exposure compensation, 16
- Extension, 68

F

- Face-priority AF, 19–20
- Fill flash, 14
- Firmware, 47
- Firmware version**, 47
- Flash, 14, 67
 - mode, 14, 66, 67
- Flash lamp, 3, 14
- Focus, 4–5, 12, 52, 53, 57
 - area, 4–5, 12, 52
 - face-priority, 19–20
 - indicator, 5, 12
 - lock, 53

- mode, 52, 57
- movie, 57
- shooting, 52
- Format, 9, 46
- Format card**, 46
- Format memory**, 46
- Framing, 11, 18–21, 43, 52, 53
 - assist, 18–21
 - guides, 18–21, 43

H

- Help, 40

I

- Image mode**, 17, 48
- Image size, *see* **Image mode**
- Indoor photography, 12, 14, 22
- Interface**, 31–35, 46
- Internal memory, 4–5, 9, 46, 67
 - capacity of, 67
 - formatting, 46

J

- JPEG, 68
- JPG, 68

L

- Landscapes, 19, 22–23
- Language**, 7, 46
- Language, choosing, 7
- Lens, 2, 60

M

- Macro close-up, 16
- Memory cards, 4–5, 9, 46, 58, 67
 - approved, 58
 - capacity of, 67
 - formatting, 46
 - inserting and removing, 9
- Memory card slot, 2, 9
- Menus, 39
- MENU** button, 3, 39
- Menus**, 47
- Metering**, 50
- Mode selector, 3
- Monitor, 3, 4–5, 10, 43, 60
 - brightness, 43
 - indicators in, 4–5
- Monitor settings**, 43
- MOV, 68
- Movies, 25, 30, 57
 - recording, 25, 57

viewing, 30
MOVIE menu, 57
Moving subjects, 21, 51
Multi selector, 3, 7, 39

N
Night photography, 14, 21, 22–23
Noise reduction, 12, 19–23
NTSC, *see* Video mode
Number of exposures remaining,
10, 67

O
On/off, *see* Power switch

P
PAL, *see* Video mode
Panorama, 23–24

Photo info, *see* **Monitor settings**

PictBridge, 34–38, 66
PictureProject, 1, 31–33
PLAYBACK MENU, 39, 54–56
Playback, 13, 26–30
 full-frame, 13, 26
 menu, 39, 54–56
 movies, 30
 on TV, 31
 thumbnail, 26
 voice memo, 29
 zoom, 27

Portraits, 19–20, 21
Power-on lamp, 2, 10
Power switch, 2, 10, 45
Printing pictures, 34–38. *See also* Date and time, printing;
Date imprint; Digital Print Order Format; PictBridge; **Print set**
Print set, 38, 54
Print size, 36, 37, 67
Protect, 55
Protected pictures, 55, 69

Q
QuickTime, 70

R
Red-eye reduction, *see* Flash, mode
Reset all, 47, 66–67

S
SCENE (scene) mode, 17–24
 Back light (🌙), 23
 Beach/Snow (🏖️), 22
 Close-up (👤), 23
 Copy (📄), 23
 Dusk/Dawn (🌅), 23
 Fireworks show (🎆), 23
 Landscape (🏞️), 19
 Museum (🏛️), 23
 Night landscape (🌃), 23
 Night portrait (👤), 21
 Panorama assist (📷), 23
 Party/Indoor (🎉), 22
 Portrait (👤), 19–20
 Sports (🏃), 21
 Sunset (🌅), 22

Secure Digital (SD), *see* Memory cards
Self-timer, 15, 68
Self-timer lamp, 2, 15
Sepia, 52

SET-UP MENU, 39, 41–47
SHOOTING MENU, 39, 48–53
Shutter-release button, 2, 12
Shutter sound, *see* **Sound settings**

Single AF, *see* Focus, mode
Size, *see* **Image mode**
Sleep mode, *see* **Auto off**
Slide show, 54
Slow sync, *see* Flash, mode
Small pic., 56, 69
Smear, 60
Sound, 2, 25, 29, 30, 45

Sound settings, 45
Speedlight, *see* Flash
Standby mode, *see* Auto off
Start-up sound, *see* **Sound settings**
Strap, camera, 2
Support information, 1

T
Telephoto, *see* Zoom
Television, 31, 46
 connecting to, 31, 46
Thumbnail playback, 26
Time, *see* **Date**
Time zone, 7–8, 42, 69
Timer, *see* Self-timer

Transfer, 31–33
 mark, 32, 46, 55
 marking pictures for, 46, 55

Transfer marking, 55
Tripod, 3
T button, *see* Zoom buttons

U
USB, 46. *See also* **Interface**
USB, 31–35, 46
 cable, 31, 32, 35
 connection, 31–35, 46
 connector, 3

V
VCR, 31
Video mode, 31, 46. *See also* **Interface**
Vivid color, 52
Voice memo, 29
Volume, 29, 30, 45

W
WAV, 68
Welcome screen, 41
White balance, 49–50
White balance, 49–50, 68
 preset, 49–50
Wide angle, *see* Zoom
W button, *see* Zoom buttons

Z
Zoom, 11
 digital, 11
 indicator, 4–5, 11
 optical, 11
 playback, 27
Zoom buttons, 3, 11

No reproduction in any form of this manual, in whole or in part (except for brief quotation in critical articles or reviews), may be made without written authorization from NIKON CORPORATION.