

Canon

# EOS-1D

## Mark II N DIGITAL



**Exif Print**

**DPOF**

**PictBridge**

**DIRECT  
PRINT**

**BUBBLE JET  
DIRECT**

**ENGLISH**

**INSTRUCTION  
MANUAL**

Canon

EOS-1D

Mark II N

INSTRUCTION MANUAL

# Thank you for purchasing a Canon product.

The EOS-1D Mark II N is a high-performance, digital AF SLR camera with a large, fine-detail, 8.20-megapixel CMOS sensor. The camera is compatible with all Canon EF lenses (except the EF-S lenses) and designed for quick shooting at will. Besides high-precision Area AF, the camera has many features for all types of photography, from fully automatic snapshotting to professional-level, creative work.

Read this Instruction Manual to familiarize yourself with the proper operation of this camera.

## Test the Camera Before Using

Before using the camera, take a few test shots and check that the images are properly recorded on the memory card.

If the camera or memory card is faulty and the images cannot be recorded or read by a personal computer, Canon cannot be held liable for any loss or inconvenience caused.

## Copyrights

Copyright laws in your country may prohibit the use of images of people and certain subjects for anything but private enjoyment. Also be aware that certain public performances, exhibitions, etc. , may prohibit photography.

- Canon and EOS are trademarks of Canon Inc.
- Adobe is a trademark of Adobe Systems Incorporated.
- CompactFlash is a trademark of SanDisk Corporation.
- Windows is a trademark or registered trademark of Microsoft Corporation in the United States and other countries.
- Macintosh is a registered trademark of Apple Corporation in the United States and other countries.
- SD is a trademark.
- All other corporate names and trademarks mentioned in this manual are the property of their respective owners.

\* This digital camera supports Design rule for Camera File System 2.0 and Exif 2.21 (also called "Exif Print"). Exif Print is a standard that enhances compatibility between digital cameras and printers. By connecting to an Exif Print-compliant printer, the camera setting information is incorporated and optimized to obtain better print output quality.

## Item Check List

---

Check that all the following items have been included with your camera. If anything is missing, contact your dealer.

The accessories included can also be checked in the System Map (p.184).

---

- EOS-1D Mark II N** / Camera body (Eyecup, body cap, and battery compartment cap attached. Built-in lithium battery for date/time.)
  - Ni-MH Pack NP-E3** (protective cover included)
  - Ni-MH Charger NC-E2**
  - DC Coupler Kit DCK-E1**
  - Wide Strap L5**
  - Interface Cable IFC-200D4**
  - Cable Protector**
  - Interface Cable IFC-400PCU**
  - Video Cable VC-100**
- 

- EOS DIGITAL Solution Disk** (CD-ROM)
  - Software Instruction Manual** (CD-ROM, PDF)
- 

### **Pocket Guide**

Quick start guide to shooting.

- EOS-1D Mark II N Instruction Manual** (this booklet)

### **Software Guide**

Gives an overview of the bundled software and explains the software installation procedure.

---

### **Warranty card**

---

\* Be careful not to lose any of the above items.

\* No memory card (for recording images) is included. Please purchase it separately. Memory cards made by Canon are recommended.

# Contents

## Introduction

Item Check List.....	3
Contents at a Glance.....	6
Handling Precautions.....	10
Quick Start Guide.....	12
Nomenclature.....	14
Conventions Used in this Manual.....	20

## 1 Getting Started

21

Recharging the Battery.....	22
Installing and Removing the Battery.....	25
Using a Household Power Outlet.....	27
Mounting and Detaching a Lens.....	29
Installing and Removing the Memory Card.....	30
Basic Operation.....	33
Menu Operations.....	38
Restoring the Default Settings.....	42
Dioptric Adjustment.....	43
Holding the Camera.....	43
Setting the Language.....	44
Set the power-off time/Auto power off.....	45
Setting the Date and Time.....	46
Replacing the Date/Time Battery.....	47
Cleaning the CMOS sensor.....	48
Attaching the Neck Strap and Hand Strap.....	50

## 2 Image Settings

51

Setting the Image-recording Quality.....	52
Setting the ISO Speed.....	55
Selecting a Picture Style.....	56
Customizing the Picture Style.....	58
Registering the Picture Style.....	61
Setting the Color Space.....	63
Selecting the White Balance.....	64
Custom White Balance.....	65
Setting the Color Temperature.....	67
White Balance Correction.....	68
White Balance Auto Bracketing.....	69
Setting the Folder and Memory Card.....	71
Creating a New Folder.....	71
Selecting a Folder.....	72
Selecting the Memory Card.....	72
Recording Identical Images on Both Cards (Dual image recording).....	73
Record RAW+JPEG Images Separately (RAW+JPEG separate recording).....	74
Setting the File Name.....	75
File Numbering Methods.....	76
Noise Reduction of Long Exposures.....	78

<b>3</b>	<b>Autofocus and Drive Modes</b>	<b>79</b>	
	Selecting the AF Mode.....	80	
	Selecting the AF Point.....	82	
	Registering and Switching the AF Point.....	84	
	AF Point Activation Area .....	86	<b>1</b>
	AF Sensitivity and Lens' Maximum Aperture .....	87	
	When Autofocus Fails (Manual Focusing) .....	89	
	Selecting the Drive Mode.....	91	
	Self-timer Operation .....	92	
<b>4</b>	<b>Exposure Control</b>	<b>93</b>	<b>2</b>
	Selecting a Metering Mode .....	94	
	Program AE.....	98	
	Shutter-Priority AE .....	100	
	Aperture-Priority AE .....	102	<b>3</b>
	Depth-of-field Preview.....	103	
	Manual Exposure .....	104	
	Setting Exposure Compensation.....	106	
	Auto Exposure Bracketing.....	107	
	AE Lock.....	109	<b>4</b>
	Bulb Exposures .....	110	
	LCD Panel Illumination.....	110	
	Mirror Lockup .....	111	
	Eyepiece Shutter.....	111	
	Flash Photography .....	112	<b>5</b>
<b>5</b>	<b>Image Playback</b>	<b>115</b>	
	Reviewing Images.....	116	
	Auto Image Rotation .....	118	
	Setting the LCD Brightness.....	119	<b>6</b>
	Image Playback.....	120	
	Changing the Image Display Format.....	121	
	Shooting Information Display .....	122	
	Magnified View .....	124	
	Rotating an Image.....	125	<b>7</b>
	Viewing the Images on TV .....	126	
	Image Protection.....	127	
	Sound Recording for an Image .....	129	
	Erasing Images .....	130	
	Formatting a Memory Card .....	133	<b>8</b>
	About Low-level Formatting .....	134	
<b>6</b>	<b>Direct Printing from the Camera</b>	<b>135</b>	
<b>7</b>	<b>DPOF: Digital Print Order Format</b>	<b>151</b>	<b>9</b>
<b>8</b>	<b>Customizing the Camera</b>	<b>159</b>	
<b>9</b>	<b>Reference</b>	<b>175</b>	

# Contents at a Glance

## Image Quality

- **Set picture effects** → p.56 (Selecting a Picture Style)

---

- **Set custom picture effects** → p.58  
(Customizing the Picture Style)

---

- **Print the image to a large size** → p.52, 54  
(**L**, **RAW**, Compression rate ▲)

---

- **Take many photos** → p.52, 54  
(**S**, Compression rate ▲)

---

- **Adjust the color tone** → p.68, 69  
(WB correction, WB bracketing)

---

- **Take black-and-white or sepia photos**  
→ p.57 (Monochrome)

## Focusing

- **Change the AF point** → p.82 (⌂ Selecting the AF point)

---

- **Photograph a still subject** → p.80 (One-Shot AF)

---

- **Photograph a moving subject** → p.80 (AI Servo AF)

---

- **Set the number of AF points from 45 to 11 or 9**  
→ p.166 (C.Fn-13-1, 2, 3, 4)

---

- **Enhance subject tracking with AI SERVO AF**  
→ p.86 (AF point expansion)

## Drive

- **Change the continuous shooting speed**  
→ p.91 (Drive)

## Shooting

- **Freeze or blur the action** → p.100 (**Tv** Shutter-priority AE)



---

- **Blur or the background or make everything look sharp**  
→ p.102 (**Av** Aperture-priority AE)

---

- **Set the ISO speed to suit the scene's brightness**  
→ p.55 (ISO speed)

---

- **Adjust the image brightness (exposure)**  
→ p.106, 107 ( Exposure compensation,  AEB)

---

- **Set mirror lockup** → p.111 (Mirror lockup)

---

- **Create a new folder to save images**  
→ p.71 (Creating a folder)

---

- **Image backup on another card** → p.73 (Dual image recording)

---

- **Save RAW and JPEG images separately**  
→ p.74 (RAW+JPEG separate recording)

---

- **Restore camera's default settings**  
→ p.42 (Reset camera settings)

## Image Playback and Printing

- **Check the shooting data** → p.122 (Shooting information display)

---

- **Check the focus precision** → p.124 (Magnified zoom display)

---

- **Prevent accidental erasure of an image**  
→ p.127 ( Protect)

---

- **Erase an image** → p.130 ( Erase)

## Safety Warnings

Follow these safeguards and use the equipment properly to prevent injury, death, and material damage.

### Preventing Serious Injury or Death

- To prevent fire, excessive heat, chemical leakage, and explosions, follow the safeguards below:
  - Do not use any batteries, power sources, and accessories not specified in this booklet. Do not use any home-made or modified batteries.
  - Do not short-circuit, disassemble, or modify the battery pack or back-up battery. Do not apply heat or apply solder to the battery pack or back-up battery. Do not expose the battery pack or back-up battery to fire or water. And do not subject the battery pack or back-up battery to strong physical shock.
  - Do not install the battery pack or back-up battery in reversed polarity (+ -). Do not mix new and old or different types of batteries.
  - Do not recharge the battery pack outside the allowable ambient temperature range of 0°C - 40°C. Also, do not exceed the recharging time.
  - Do not insert any foreign metallic objects into the electrical contacts of the camera, accessories, connecting cables, etc.
- Keep the back-up battery away from children. If a child swallows the battery, consult a physician immediately. (Battery chemicals may harm the stomach and intestines.)
- When disposing of a battery pack or back-up battery, insulate the electrical contacts with tape to prevent contact with other metallic objects or batteries. This is to prevent fire or an explosion.
- If excessive heat, smoke, or fumes are emitted during battery pack recharging, immediately unplug the battery charger from the power outlet to stop the recharging and prevent a fire.
- If the battery pack or back-up battery leaks, changes color, deforms, or emits smoke or fumes, remove it immediately. Be careful not to get burned in the process.
- Prevent any battery leakage from contacting your eyes, skin, and clothing. It can cause blindness or skin problems. If the battery leakage contacts your eyes, skin, or clothing, flush the affected area with lots of clean water without rubbing it. See a physician immediately.
- During the recharging, keep the equipment away from the reach of children. The cord can accidentally choke the child or give an electrical shock.
- Do not leave any cords near a heat source. It can deform the cord or melt the insulation and cause a fire or electrical shock.
- Do not fire the flash at someone driving a car. It may cause an accident.
- Do not fire the flash near a person's eyes. It may impair the person's vision. When using flash to photograph an infant, keep at least 1 meter away.
- Before storing the camera or accessory when not in use, remove the battery pack and disconnect the power plug. This is to prevent electrical shock, heat generation, and fire.
- Do not use the equipment where there is flammable gas. This is to prevent an explosion or fire.



- 
- If you drop the equipment and the casing breaks open to expose the internal parts, do not touch the internal parts due to the possibility of electrical shock.
  - Do not disassemble or modify the equipment. High-voltage internal parts can cause electrical shock.
  - Do not look at the sun or an extremely bright light source through the camera or lens. Doing so may damage your vision.
  - Keep the camera from the reach of small children. The neck strap can accidentally choke the child.
  - Do not store the equipment in dusty or humid places. This is to prevent fire and electrical shock.
  - Before using the camera inside an airplane or hospital, check if it is allowed. Electromagnetic waves emitted by the camera may interfere with the plane's instruments or the hospital's medical equipment.
  - To prevent fire and electrical shock, follow the safeguards below:
    - Always insert the power plug all the way in.
    - Do not handle a power plug with wet hands.
    - When unplugging a power plug, grasp and pull the plug instead of the cord.
    - Do not scratch, cut, or excessively bend the cord or put a heavy object on the cord. Also do not twist or tie the cords.
    - Do not connect too many power plugs to the same power outlet.
    - Do not use a cord whose insulation has been damaged.
  - Occasionally unplug the power plug and use a dry cloth to clean off the dust around the power outlet. If the surrounding is dusty, humid, or oily, the dust on the power outlet may become moist and short-circuit the outlet to cause a fire.
- 

## Preventing Injury or Equipment Damage

- Do not leave equipment inside a car under the hot sun or near a heat source. The equipment may become hot and cause skin burns.
  - Do not carry the camera around while it is attached to a tripod. Doing so may cause injury. Also make sure the tripod is sturdy enough to support the camera and lens.
  - Do not leave a lens or lens-attached camera under the sun without the lens cap attached. Otherwise, the lens may concentrate the sun's rays and cause a fire.
  - Do not cover or wrap the battery-recharging apparatus with a cloth. Doing so may trap heat within and cause the casing to deform or catch fire.
  - If you drop the camera in water or if water or metal fragments enter inside the camera, promptly remove the battery pack and back-up battery. This is to prevent fire and electrical shock.
  - Do not use or leave the battery pack or back-up battery in a hot environment. Doing so may cause battery leakage or a shorter battery life. The battery pack or back-up battery can also become hot and cause skin burns.
  - Do not use paint thinner, benzene, or other organic solvents to clean the equipment. Doing so may cause fire or a health hazard.
- 

**If the product does not work properly or requires repair, contact your dealer or your nearest Canon Service Center.**

# Handling Precautions

## Camera Care

- This camera is a precision instrument. Do not drop it or subject it to physical shock.
- The camera is not waterproof and cannot be used underwater. If you accidentally drop the camera into water, remove the battery and promptly consult your nearest Canon Service Center. Wipe off any water droplets with a dry cloth. If the camera has been exposed to salty air, wipe with a well-wrung wet cloth.
- Never leave the camera near anything having a strong magnetic field such as a magnet or electric motor. Also avoid using or leaving the camera near anything emitting strong radio waves such as a large antenna. Strong magnetic fields can cause camera misoperation or destroy image data.
- Do not leave the camera in excessive heat such as in a car in direct sunlight. High temperatures can cause the camera to malfunction.
- The camera contains precision electronic circuitry. Never attempt to disassemble the camera yourself.
- Use a blower to blow away dust on the lens, viewfinder, mirror, and focusing screen. Do not use cleaners that contain organic solvents to clean the camera body or lens. For stubborn dirt, take the camera to a Canon Service Center.
- Do not touch the camera's electrical contacts with your fingers. This is to prevent the contacts from corroding. Corroded contacts can cause camera misoperation.
- If the camera is suddenly brought in from the cold into a warm room, condensation may form on the camera and internal parts. To prevent condensation, first put the camera in a sealed plastic bag and let it adjust to the warmer temperature before taking it out of the bag.
- If condensation forms on the camera, do not use the camera. This is to avoid damaging the camera. If this occurs, remove the lens, memory card and battery from the camera, and wait until the condensation has evaporated before using the camera.
- If the camera will not be used for an extended period, remove the battery and store the camera in a cool, dry, well-ventilated location. Even while the camera is in storage, press the shutter button a few times once in a while to check that the camera is still working.
- Avoid storing the camera where there are corrosive chemicals such as a darkroom or chemical lab.
- If the camera has not been used for an extended period, test all its functions before using the camera. If you have not used the camera for some time or if there is an important shoot coming up, have the camera checked by your Canon dealer or check the camera yourself and make sure it is working properly.

## LCD Panels and LCD Monitor

- Although the LCD monitor is manufactured with very high precision technology with over 99.99% active pixels, there might be a few dead pixels among the remaining 0.01% or less pixels. Dead pixels displaying only black or red, etc., are not a malfunction. They do not affect the images recorded.
- At low temperatures, the liquid-crystal display response may become slower. And at high temperatures, the display may blacken. In either case, the display will return to normal at room temperature.

## Memory Cards

- Memory cards are precision device. Do not drop the memory card or subject it to vibration. Doing so could damage the images recorded on them.
- Do not store or use a memory card near anything having a strong magnetic field such as a TV set, speakers, or magnet. Also avoid places prone to having static electricity. Otherwise, the images recorded on the memory card might be lost.
- Do not leave memory cards in direct sunlight or near a heat source. Doing so can warp the cards and make them unusable.
- Do not spill any liquid onto the memory card.
- Always store your memory cards in a case to protect the data stored on them.
- Non-Canon memory cards may not be able to record and playback images. Using Canon memory cards is recommended.
- Do not bend the card or subject it to any excessive force or physical shock.
- Do not store memory cards in hot, dusty, or humid locations.

## Lens Electrical Contacts

After detaching the lens from the camera, attach the lens caps or put down the lens with the rear end up to avoid scratching the lens surface and electrical contacts.

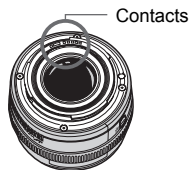

## Cautions for Prolonged Use

When the  switch is left <ON> for a prolonged period, the camera may become hot. Although this is not a malfunction, holding the hot camera for a long period can cause slight skin burns.

# Quick Start Guide

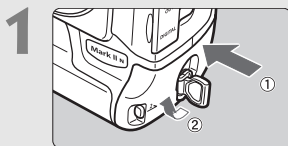

## Insert the battery. (p.25)

Take off the cap and insert a fully-charged battery.



## Attach the lens. (p.29)

Align the red dot.

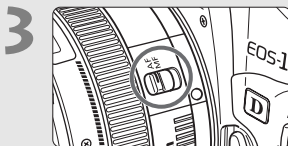

## Set the lens focus mode switch to <AF>. (p.29)

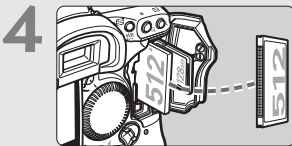

## Insert a memory card. (p.30)

Insert a CF card into the left slot and/or insert an SD card into the right slot.

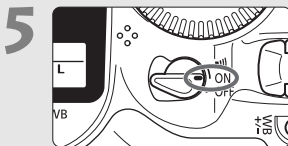

## Set the power switch to <ON>. (p.33)

6

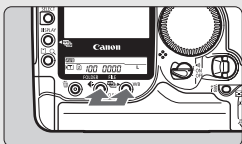

### Set the camera to the default settings. (p.42)

Press the **<P>** and **<WB>** buttons together for 2 sec.

- The **<P>** Program AE mode will be set.

7



### Focus the subject. (p.34)

Aim the AF point over the subject and press the shutter button halfway to autofocus.

8

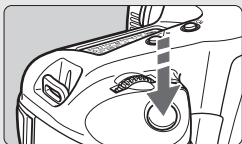

### Take the picture. (p.34)

Press the shutter button fully to take the picture.

9



### View the image. (p.116)

The image will be displayed for about 2 sec.

- Shooting will be possible only when a CF card or SD card is in the camera.
- To view images captured so far, see “Image Playback” (p.120).
- To delete an image, see “Erasing Images” (p.130).

# Nomenclature

For detailed information, reference page numbers are provided in parentheses (p. \*\*).

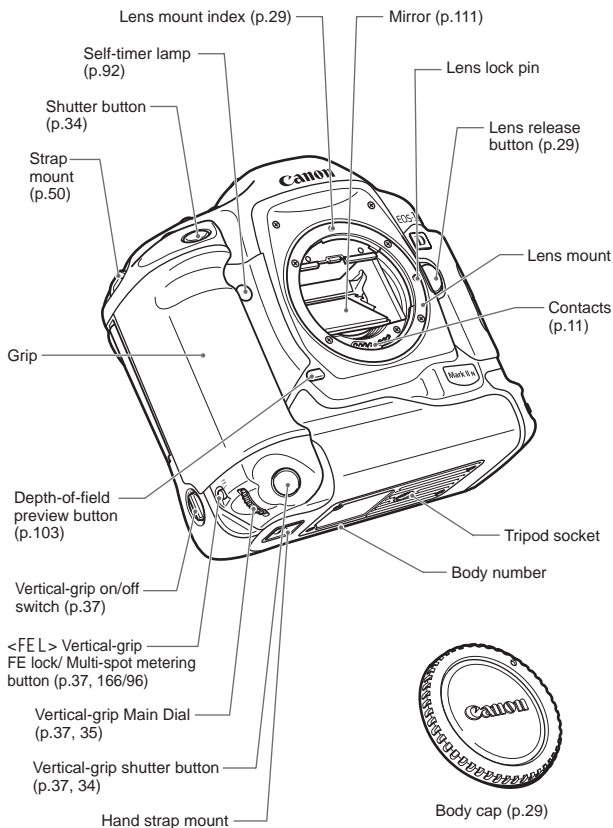

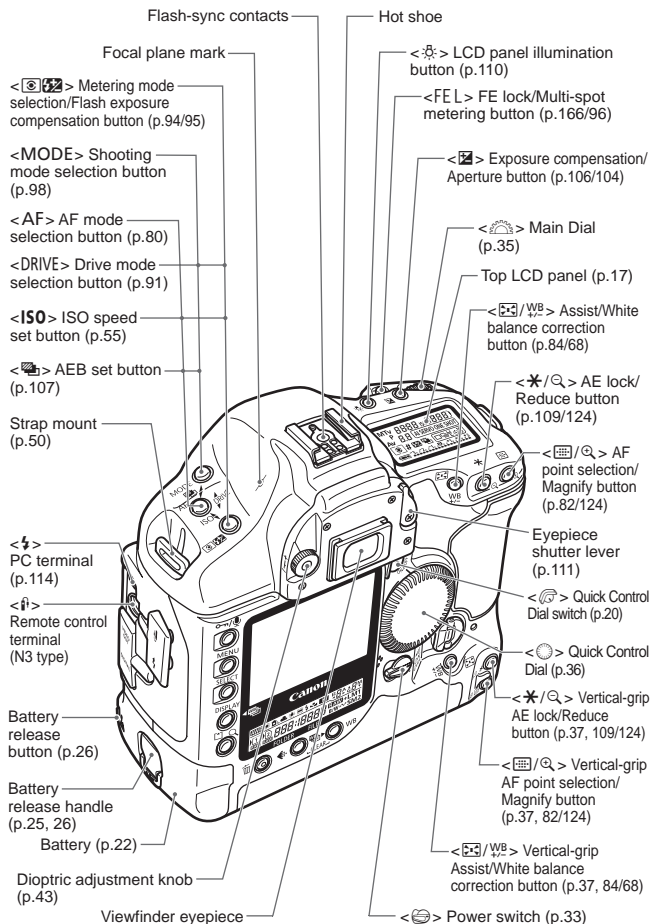

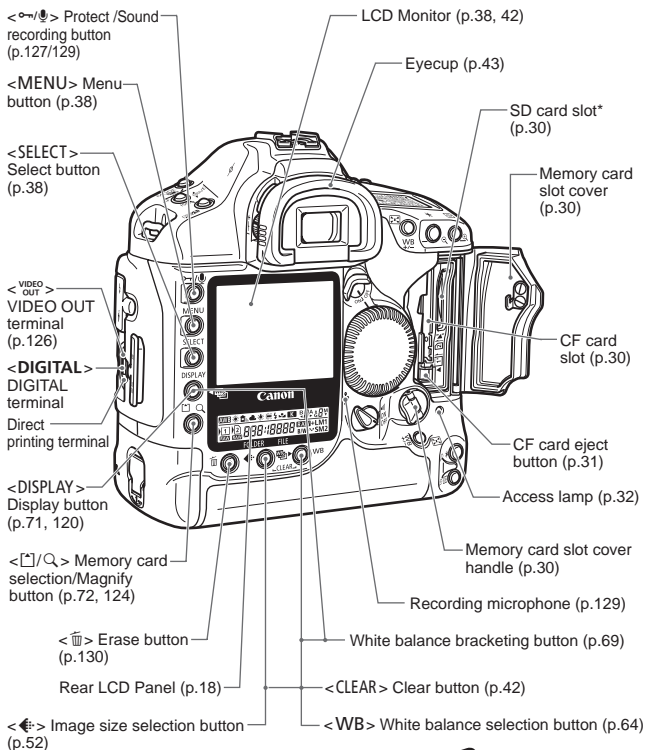

Battery compartment cap (p.25)



\* In this manual, "SD card" refers to the SD memory card.



## Top LCD Panel

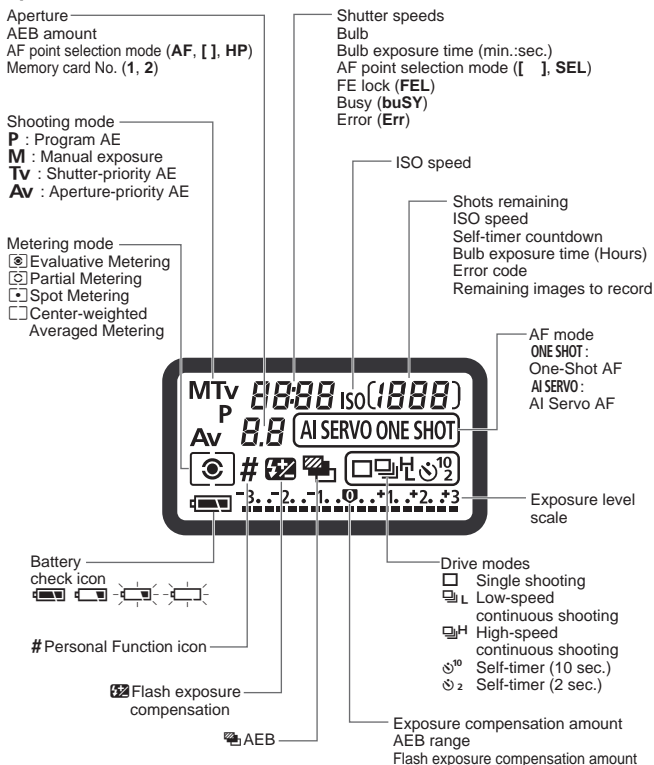

The actual display will show only the applicable items.

## Rear LCD Panel

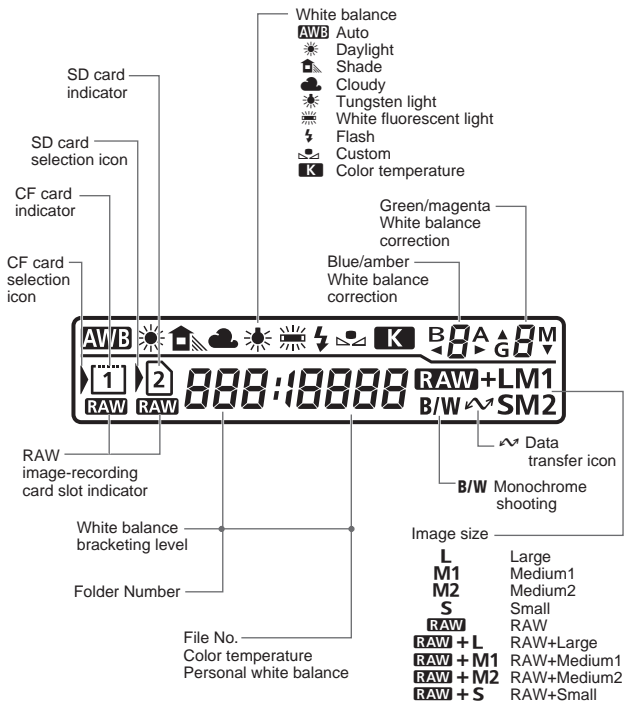

The actual display will show only the applicable items.

## Viewfinder Information

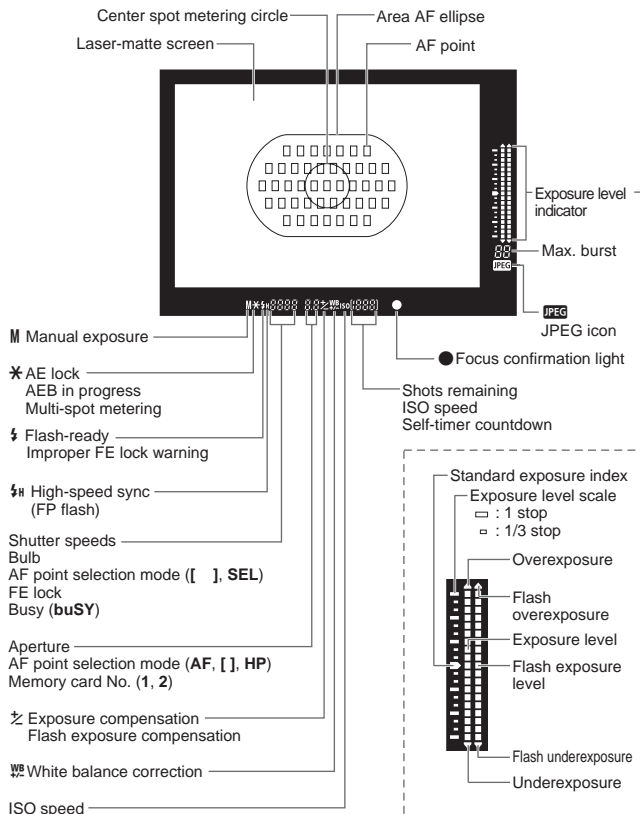

The actual display will show only the applicable items.

## Conventions Used in this Manual

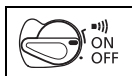

- In the text, the <img alt="power switch icon" data-bbox="255 108 285 138"/> icon indicates the power switch. All operations described in this manual assume that the <img alt="power switch icon" data-bbox="255 155 285 185"/> switch is set to <ON> or <■||>.



- The <img alt="Main Dial icon" data-bbox="325 212 365 232"/> icon indicates the Main Dial.





- The <img alt="Quick Control Dial icon" data-bbox="325 290 355 310"/> icon indicates the Quick Control Dial.



- The <img alt="Quick Control Dial switch icon" data-bbox="325 346 365 376"/> icon indicates the Quick Control Dial switch.
- Operations with the <img alt="Quick Control Dial icon" data-bbox="325 290 355 310"/> dial assume that the <img alt="Quick Control Dial switch icon" data-bbox="325 346 365 376"/> switch is already set to <ON>. Be sure it is set to <ON>.

- In this manual, the icons and markings indicating the camera's buttons, dials, and settings correspond to the icons and markings on the camera.
- For more information, reference page numbers are provided in parentheses (p.\*\*).
- The Canon EF50mm f/1.4 USM lens is used as the demonstration lens in this Instruction Manual.
- The procedures assume that the menu settings and Custom Functions are set to the default settings.
- The **MENU** icon indicates that the setting can be changed with the menu.
- (6) or (16) indicates that the relevant function remains active for 6 sec. or 16 sec. respectively after you let go of the button.
- This manual uses the following alert symbols:

: The Caution symbol indicates a warning to prevent shooting problems.

: The Note symbol gives supplemental information.

# 1

## Getting Started

---

This chapter explains a few preparatory steps and basic operations with the EOS-1D Mark II N.

# Recharging the Battery

To charge the Ni-MH Pack NP-E3, connect it to Ni-MH Charger NC-E2.

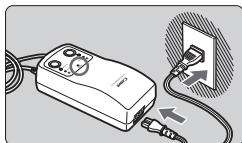
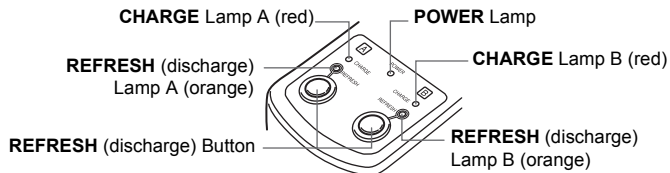

## 1 Connect the power cord.

- Connect the AC plug to a power outlet and connect the power cord to the charger.
- ▶ The <POWER> lamp will light.

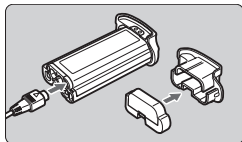

## 2 Detach the protective cover and connect the battery.

- Connect the charger's charge/discharge plug to the battery's socket.
- Attach the cover to the battery compartment cap and store it.

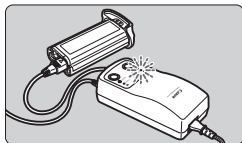

## 3 Recharge the battery.

- ▶ When you connect the battery, the recharging will start automatically and the red <CHARGE> lamp will light.
- **It takes about 120 minutes to fully recharge a completely exhausted battery.**
- When the battery is fully charged, the <CHARGE> lamp will blink quickly (twice per sec.).
- After recharging the battery, disconnect it and unplug the power cord from the power outlet.

## Refreshing the Battery

If the Ni-MH battery is repeatedly recharged before it has discharged completely, the capacity degrades due to the memory effect. To eliminate this memory effect, follow the procedure below.

### 1 Connect the battery.

### 2 Hold down the button until the orange <REFRESH> lamp lights.

- ▶ The battery will begin to discharge.
- The discharge time will vary depending on the remaining capacity. Discharging a fully-charged battery will take about 8.5 hours.
- When the discharge is completed, charging will start automatically.
- To interrupt the discharge, press the <REFRESH> button until the red <CHARGE> lamp lights.



- When two batteries are connected, the battery which was connected first will be charged first. After the first battery is fully charged, the other battery will start charging automatically. The battery waiting to be charged will have the <CHARGE> lamp blinking slowly (every other second). And when two batteries are to be discharged, the battery waiting to be discharged will have the <REFRESH> lamp blinking slowly.
- Also, with two batteries connected, one can be charging while the other is discharging.
- If you only want to discharge the battery, you need not connect the power cord to a power outlet. Press the <REFRESH> button. When the discharge is completed, the <REFRESH> lamp will turn off.
- The NC-E2 is compatible with 100-240 V AC. It can also be used with a commercially-available AC plug compatible with the respective country's power outlet.
- Whenever the battery is out of the camera, be sure to attach the protective cover to prevent a short circuit.
- The Ni-MH battery discharges naturally even while it is not used. You should charge the battery at least once every 6 months.
- The NP-E3 is dedicated to the EOS-1D series camera. It cannot be used with Power Drive Booster PB-E2.



## Lamp Indications

	Lights	Slow Blinking (every other second)	Fast Blinking (twice per second)	Off
<b>CHARGE</b> lamp	Charging	Waiting to be charged	Fully charged	Battery not connected
<b>REFRESH</b> lamp	Discharging	Waiting to be discharged	–	Fully discharged

### Charge and Discharge Indications

#### <CHARGE> lamp does not light

If the battery temperature is not within 0°C to 40°C when you connect it, charging is disabled for safety reasons. Battery charging will be possible after the battery temperature returns to normal.

#### <CHARGE> lamp and <REFRESH> lamp both blink during charging

An abnormally-high battery temperature was detected so the charging was terminated. Consult your dealer or nearest Canon Service Center.

#### <REFRESH> lamp does not light

If the battery cannot be discharged even if it has some charge left, there might be a problem with the battery. Consult your dealer or your nearest Canon Service Center.



# Installing and Removing the Battery

## Installing the Battery

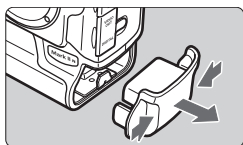

### 1 Detach the battery compartment cap.

- Grasp both sides of the cap and pull it off.

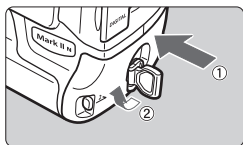

### 2 Insert the battery.

- Insert the battery and while pushing it in, turn the release handle as shown by the arrow.



If the battery's rubber lining (to repel water) is not clean, use a moist cotton swab to wipe it clean.

Rubber lining



## Checking the Battery Level

When the  switch is set to <ON> (p.33), the battery level will be indicated at one of four levels:

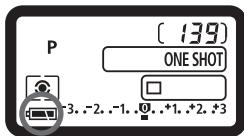

 : Battery level OK.

 : Battery level is low.

 : Battery will be exhausted soon.

 : Battery must be recharged.

## Battery Life

Temperature	Shots remaining
At 20°C	Approx. 1200
At 0°C	Approx. 800

The figures above are based on CIPA (Camera & Imaging Products Association) testing criteria.



- The actual number of shots may be fewer than indicated above depending on the shooting conditions.
- The number of possible shots will decrease with more frequent use of the LCD monitor.
- Pressing the shutter button halfway for long periods or operating the autofocus only can reduce the number of possible shots.

## Removing the Battery

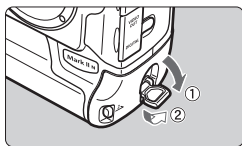

- 1** Flip out the battery release handle and turn it as shown by the arrow.

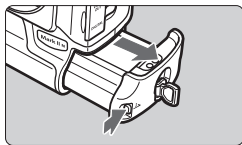

- 2** Press the battery release button and take out the battery.

# Using a Household Power Outlet

With DC Coupler Kit DCK-E1, you can connect the camera to a household power outlet and not worry about the battery level.

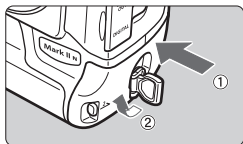
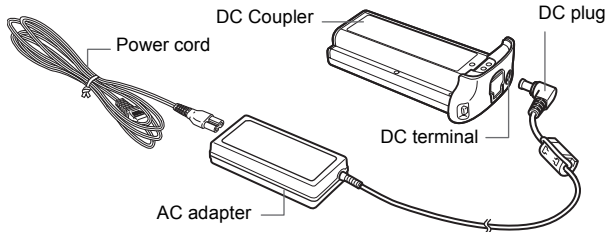

## 1 Insert the DC Coupler.

- Insert the coupler and while pushing it in, turn the release handle as shown by the arrow.

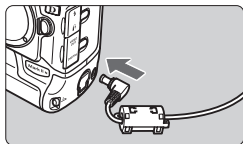

## 2 Connect the DC plug.

- Connect the AC Adapter's DC plug to the DC terminal.

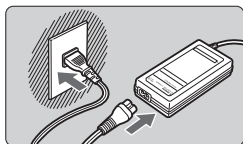

## 3 Connect the power cord.

- Connect the AC plug to the power outlet, then connect the power cord to the AC adapter.
- Turn the <ON> switch to <ON>.
- After you finish using the camera, set the <ON> switch to <OFF> and disconnect the plug from the power outlet.

- The DC Coupler is not water-resistant, so do not get it wet when using it outdoors.
- The DCK-E1 is dedicated to the EOS-1D series camera only. It cannot be used with any other camera.
- When the  switch is set to <ON>, do not disconnect the DC plug or AC adapter's power cord from the power outlet. Otherwise, the camera may stop operating. If the camera stops operating, remove the DC Coupler from the camera and reinstall it.



When connecting to and using a household power outlet, use only DC Coupler Kit DCK-E1 (rated input: 100-240 V AC 50/60 Hz, rated output: 13 V DC). Using anything else can cause fire, overheating, or electrical shock.

# Mounting and Detaching a Lens

## Mounting a Lens

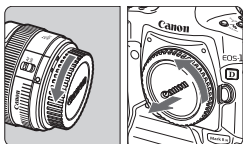

### 1 Remove the caps.

- Remove the rear lens cap and the body cap by turning them as shown by the arrow.

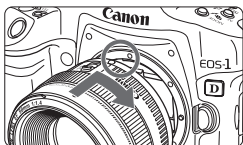

### 2 Attach the lens.

- Align the red dots on the lens and camera and turn the lens as shown by the arrow until it snaps in place.

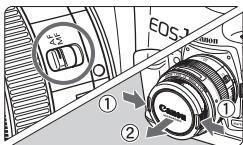

### 3 On the lens, set the focus mode switch to <AF>.

- If it is set to <MF>, autofocus will not be possible.

### 4 Remove the front lens cap.

## Detaching the Lens

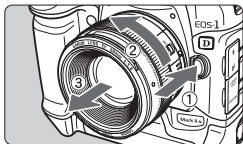

**While pressing the lens release button, turn the lens as shown by the arrow.**

- Turn the lens until the red dot is at the top, then detach the lens.



When attaching or detaching the lens, take care to prevent dust from entering the camera through the lens mount.

# Installing and Removing the Memory Card ■

The camera can use both a CF card and SD card. There must be at least one card installed to enable shooting.

If both cards are installed, you can select which card to record the images. (p.72)

- 🔊 **If you use an SD card, be sure the write protect switch is set upward to enable writing/erasing.**

## Installing the Card

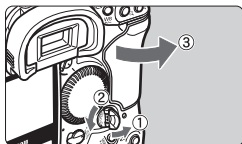

### 1 Open the cover.

- Flip up and turn the cover release handle as shown by the arrow.

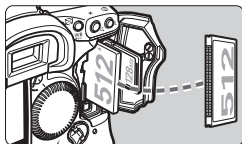

### 2 Insert the memory card into the camera.

- The left slot is for the CF card, and the right slot is for the SD card.
- **If the CF card is inserted in the wrong way, it may damage the camera. As shown by the arrow, face the label side toward you and insert the end with the small holes into the camera.**

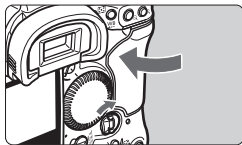

### 3 Close the cover.

- Push in the cover until the cover release handle returns to its original position.

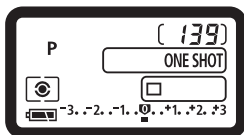

CF card indicator

SD card indicator



Memory card selection icon

## 4 Turn the <☺> switch to <ON>.

- ▶ The number of possible shots will be displayed on the top LCD panel and in the viewfinder.
- ▶ The folder No. and file No. will be displayed on the rear LCD panel. The <▶> icon for the memory card in use will also be displayed.



The camera is compatible with Type I and Type II CF cards.

## Removing the Card

### 1 Open the cover.

- Turn the <☺> switch to <OFF>.
- Make sure the access lamp is off and “buSY” is not displayed on the top LCD panel. Then open the cover.

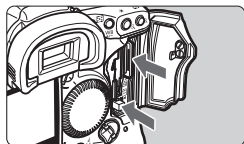

### 2 Take out the memory card.

- To remove the CF card, press the Eject button.
- To remove the SD card, push it in and release it.

- The access lamp lights or blinks while the picture is taken, when data is being transferred to the memory card and when data is being recorded, read, or erased on the memory card. Never do the following while the access lamp is lit or blinking. Such actions may destroy the image data. It may also damage the memory card or camera.
  - Shaking or banging the camera around.
  - Open the memory card slot cover.
  - Removing the battery.
- After image capture, you cannot do any menu operation while the image is processed and recorded onto the memory card (lit or blinking access lamp).
- When the memory card becomes full, the “**Card Full**” warning will appear on the LCD panel and in the viewfinder. Shooting will be disabled. Replace the memory card with one that is not full.
- If “**Card Err** (Card error)” is displayed on the LCD panel, see page 134.

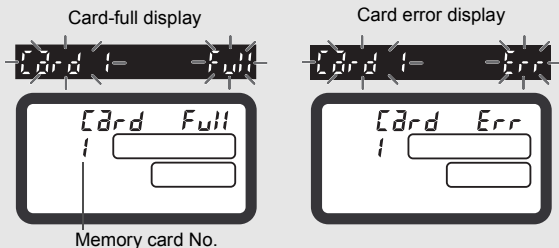

- If you use a low-capacity memory card, it might not be able to record large images.
- Microdrive cards are more vulnerable to vibration and physical shock. If you use a microdrive, be careful not to subject the camera to vibration or physical shock while recording or playing images.
- Do not touch the SD card's contacts with your fingers or metal objects.



# Basic Operation

## Power Switch

The camera can operate only after the  switch is turned on.

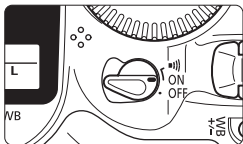

- <OFF> : The camera is turned off and does not operate.
- <ON> : To turn on the camera, set to this position.
-  > : This is the same as <ON> except that the beeper sounds when focus is achieved in the One-Shot AF mode or with manual focus.



- To save battery power, the camera turns off automatically after 1 minute of non-operation (p.45). To turn on the camera again, just press the shutter button halfway.
- If you turn the  switch to <OFF> while the captured images are being recorded onto the memory card, the remaining number of captured images to be recorded will be displayed on the top LCD panel. When all the images are finished recording, the display will turn off and the camera will turn off.

## Shutter Button

The shutter button has two steps. You can press the shutter button halfway. Then you can further press the shutter button completely.



### Pressing halfway (ⓘ6)

This activates autofocus (AF) and automatic exposure (AE) that sets the shutter speed and aperture.

The exposure setting (shutter speed and aperture) is displayed on the top LCD panel and in the viewfinder.

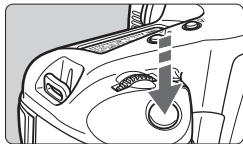

### Pressing completely

This releases the shutter and takes the picture.

- If you press the shutter button halfway and (ⓘ6) elapse, you must press it halfway again and wait a moment before pressing it completely to take a picture. If you press the shutter button completely without pressing it halfway first or if you press the shutter button halfway and then press it completely immediately, the camera will take a moment before it takes the picture.
- Regardless of the camera's current operation (image playback, menu operation, image recording, etc.), you can instantly go back to shooting by pressing the shutter button halfway. (Except during direct printing and low-level formatting.)

## Using the < > Dial

The <  > dial is mainly used for shooting-related settings. There are three ways to use this dial:

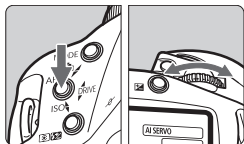

- (1) **While pressing a button, turn the <  > dial until the desired setting appears on the top LCD panel.**

When you release the button, the selected setting takes effect and the camera will be ready to shoot.

- In this way, you can set the shooting mode, AF mode, metering mode, drive mode, etc.

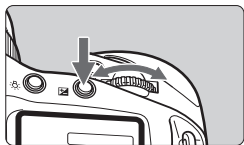

- (2) **After pressing a button, turn the <  > dial.**

When you press a button, its function remains selected for 6 seconds (ⓘ6).

During this time, you can turn the <  > dial to set the desired setting. After the button turns off or if you press the shutter button halfway, the camera will be ready to shoot.

- In this way, you can select the AF point or press the <  > button to set the exposure compensation amount.

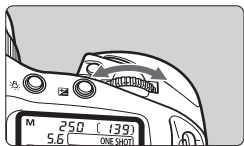

- (3) **Turn the <  > dial only.**

While referring to the top LCD panel, turn the <  > dial.

- In this way, you can set the shutter speed, aperture, etc.

## Using the <⦿> Dial

The <⦿> dial is used for AF point selection and selecting the desired setting on the LCD monitor. This <⦿> dial works only when the <⦿> switch is set to <ON>.

There are three ways to use this <⦿> dial:

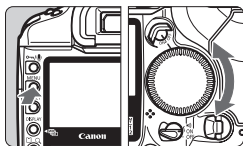

### (1) While pressing a button, turn the <⦿> dial.

- In this way, you can select and set various menu settings or set flash exposure compensation. When you let go of the button, the selected setting takes effect.
- You can also review and select images on the LCD monitor with this dial.

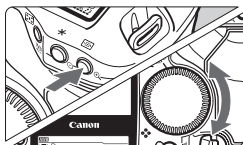

### (2) After pressing a button, turn the <⦿> dial.

When you press a button, its function remains on for 6 seconds (⦿6). During this time, you can turn the <⦿> dial to set the desired setting.

After the button turns off or if you press the shutter button halfway, the camera will be ready to shoot.

- In this way, you can select the AF point or set the exposure compensation.

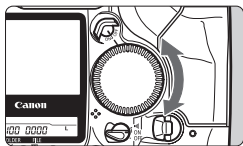

### (3) Turn the <⦿> dial only.

While turning the <⦿> dial, look at the setting in the viewfinder or on the top LCD panel.

- In this way, you can set the aperture in the camera's manual exposure mode.

## Vertical Shooting

For vertical shooting, the vertical grip (camera bottom) has a shutter button, Main Dial, AF point selection button, AE lock button, Assist button, and FE lock/multi-spot metering button.



- Before using the vertical grip controls, turn on the vertical-grip on/off switch.
- When you are not using the vertical grip, be sure to turn off the vertical-grip on/off switch to prevent inadvertent operation of the vertical grip controls.

# Menu Operations

By setting various optional settings with the menus, you can set Picture Style, the date/time, Custom Functions, etc. While looking at the LCD monitor, you use the <MENU> button, <SELECT> button, and <◂◃> dial on the camera back.

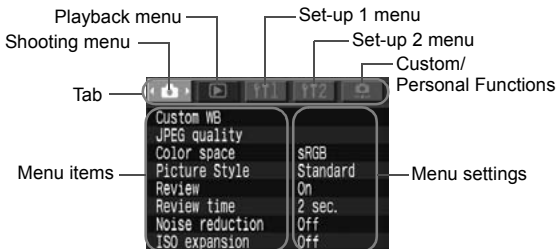
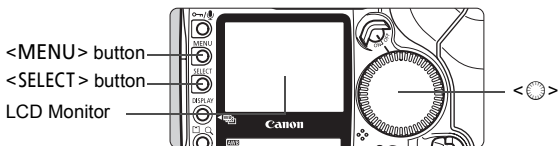

Icon	Color	Category	Description
	Red	Shooting menu	Shooting-related menu
	Blue	Playback menu	Image playback-related menu
	Yellow	Set-up menu	Camera's basic settings
	Orange	Custom Functions and Personal Functions	

- Even while the menu is displayed, you can instantly go back to shooting by pressing the shutter button halfway.
- The explanation of menu functions hereinafter assumes that the menu items or settings are displayed.

## Menu Setting Procedure

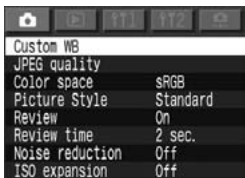

### 1 Display the menu.

- Press the <MENU> button to display the menu. To turn off the menu, press the button again.
- With the menu displayed, follow the procedure below.

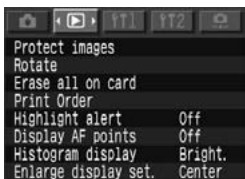

### 2 Select a menu tab (CAMERA, PLAYBACK, T1, T2, MENU).

- Hold down the <MENU> button and turn the <DIAL> to select a tab, then let go of the button.

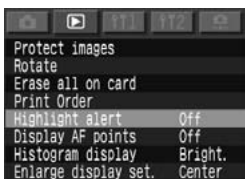

### 3 Select a menu item.

- Hold down the <SELECT> button and turn the <DIAL> to select a menu item, then let go of the button.

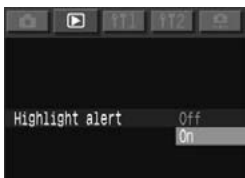

### 4 Select the desired menu setting.

- Hold down the <SELECT> button and turn the <DIAL> to select the desired setting, **then let go of the button. The setting will take effect immediately.**



## 5 Exit the menu.

- Press the <MENU> button to exit.

## Menu Settings

### <CAM> Shooting menu (Red)

Reference pages

Custom WB	Manual setting of white balance	65
JPEG quality	Compression rate for <b>L</b> , <b>M1</b> , <b>M2</b> , <b>S</b> .	54
Color space	sRGB / Adobe RGB	63
Picture Style	Standard / Portrait / Landscape / Neutral / Faithful / Monochrome / User Def. 1 / User Def. 2 / User Def. 3 / Detail set.	56, 58, 61
Review	Off / On / On (INFO.)	116
Review time	2 sec. / 4 sec. / 8 sec. / Hold	117
Noise reduction	Off / Auto / On	78, 110
ISO expansion	Off / On	55

### <PLAY> Playback menu (Blue)

Protect images	Protect image	127
Rotate	Rotate image	125
Erase all on card	Erase all data in the card	132
Print Order	Specifies images to be printed (DPOF)	151
Highlight alert	Off / On	122
Display AF points	Off / On	122
Histogram display	Bright. / RGB	123
Enlarge display set.	Enlarge from image center / Enlarge from selected AF point	124



## &lt;fT1&gt; Set-up 1 menu (Yellow)

Auto power off	1 min. / 2 min. / 4 min. / 8 min. / 15 min. / 30 min. / Off	45
File numbering	A-Reset / Continuous / M-Reset	76
File name setting	Preset camera code: **** / User setting file name: **** / Change user setting file name	75
BackUp	[Step 1] Off / [1]→ (Image 1 is displayed) / [1]→2 (Image 2 is displayed) [Step 2] Same image recorded to [1] 2 / [1]: RAW 2: JPEG / [1]: JPEG 2: RAW	73, 74
Auto rotate	On / Off	118
Save camera settings	Save camera settings to memory card	173
Loading camera settings	Read camera settings saved in memory card	174
Format	Format and erase data in memory card	133

## &lt;fT2&gt; Set-up 2 menu (Yellow)

LCD Brightness	5 levels	119
Date/Time	Date/time setting	46
Language	15 languages provided (English, German, French, Dutch, Danish, Finnish, Italian, Norwegian, Swedish, Spanish, Russian, Simplified Chinese, Traditional Chinese, Korean, and Japanese.)	44
Video system	NTSC / PAL	126
Firmware	Select to update the firmware	-
Sensor cleaning	Select to clean the image sensor	48

## &lt;fT3&gt; Custom / Personal Functions menu (Orange)

Custom Functions(C.Fn)	Customize the camera	160
Personal Functions(P.Fn)	Group registration of Custom Functions, cancel or reset Personal Functions set or registered with the bundled software	171, 172
Clear all Custom Functions	Clears all Custom Functions	160
Clear all Personal Functions	Clears all Personal Functions	172

## About the LCD Monitor

- When using the LCD monitor, you can use the  $\langle \text{Q} \rangle$  dial even while the  $\langle \text{Fn} \rangle$  switch is  $\langle \text{OFF} \rangle$ .
- The LCD monitor cannot be used as a viewfinder to shoot.
- To adjust the LCD monitor's brightness, select the  $\langle \text{Fn} \rangle$  menu tab and select [LCD Brightness]. (p.119)

## Restoring the Default Settings

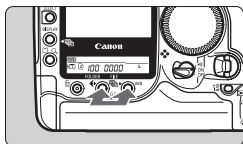

Press the  $\langle \text{Fn} \rangle$  button and  $\langle \text{WB} \rangle$  button simultaneously for 2 sec.

- ▶ The camera's default settings will be as shown below.

### Shooting Settings

Shooting mode	$\langle \text{P} \rangle$ Program AE
AF Mode	One-Shot AF
Metering mode	Evaluative metering
Drive mode	Single
AF point selection	Automatic
Exposure compensation	0 (Zero)
AEB	Canceled
AE lock	Canceled
Flash exposure compensation	0 (Zero)
FE lock	Canceled
Custom Functions	Current settings retained
AF point registration	Center AF point

### Image-Recording Settings

Image size	<b>L</b> (Large)
JPEG quality (Compression rate)	Current settings retained
ISO speed	Current settings retained
White balance	<b>AWB</b>
WB compensation	0 (Zero)
WB bracketing	Off
Color space	sRGB
Picture Style	Standard

## Dioptric Adjustment

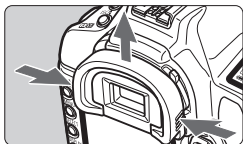

### 1 Remove the eyecup.

- While grasping both sides of the eyecup, slide it upward to remove.

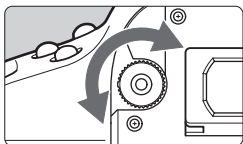

### 2 Turn the dioptic adjustment knob.

- Turn the knob to the right or left until the AF point or the center spot metering circle looks sharp in the viewfinder.

### 3 Reattach the eyecup.



If the camera's dioptic adjustment still cannot provide a clear viewfinder image, using Dioptic Adjustment Lens E (10 types, optional) is recommended. (p.183)

## Holding the Camera

To obtain sharp images, hold the camera still to minimize camera shake.



Horizontal shooting      Vertical shooting

- Firmly grasp the camera grip with your right hand, and press your both elbows lightly against your body.
- Hold the lens at the bottom with your left hand.
- Press the camera against your face and look through the viewfinder.
- To maintain a stable stance, place one foot in front of the other instead of lining up both feet.

## MENU Setting the Language

The LCD monitor's interface language can be set to one of fifteen languages.



### 1 Select [Language].

- Select the <fT2> tab.
- Hold down the <SELECT> button and turn the <⦿> dial to select [Language]. Then let go of the <SELECT> button.
- ▶ The Language screen will appear.



### 2 Set the desired language.

- Hold down the <SELECT> button and turn the <⦿> dial to select the Language. Then let go of the <SELECT> button.
- ▶ The language will change.

English	English
Deutsch	German
Français	French
Nederlands	Dutch
Dansk	Danish
Suomi	Finnish
Italiano	Italian
Norsk	Norwegian
Svenska	Swedish
Español	Spanish
Русский	Russian
简体中文	Simplified Chinese
繁體中文	Traditional Chinese
한국어	Korean
日本語	Japanese

## **MENU** Set the power-off time/Auto power off

You can set the auto power-off time for the camera to turn off automatically after a set time of idle operation. If you do not want the camera to turn off automatically, set this to **[Off]**. After the power turns off, you can turn on the camera again by pressing the shutter button or other button.

### **1** Select **[Auto power off]**.

- Select the <fT1> tab.
- Hold down the <SELECT> button and turn the <◉> dial to select **[Auto power off]**. Then let go of the <SELECT> button.



### **2** Set the desired time.

- Hold down the <SELECT> button and turn the <◉> dial to select the desired time. Then let go of the <SELECT> button.

## MENU Setting the Date and Time



### 1 Select [Date/Time].

- Select the <T2> tab.
- Hold down the <SELECT> button and turn the <DIAL> dial to select [Date/Time]. Then let go of the <SELECT> button.



### 2 Set the date and time.

- The selection shifts each time you press the <SELECT> button.
- Hold down the <SELECT> button and turn the <DIAL> dial to select the correct number. Then let go of the <SELECT> button.



### 3 Set the date display format.

- Hold down the <SELECT> button and turn the <DIAL> dial to select one of the following display formats: [mm/dd/yy], [dd/mm/yy], [yy/mm/dd]. Then let go of the button.

### 4 Press the <MENU> button.

- ▶ The date and time will be set and the menu will reappear.

ⓘ Each captured image is recorded with the date and time it was taken. If the date and time are not properly set, the wrong date/time will be recorded. Make sure you set the date and time correctly.

# Replacing the Date/Time Battery

The date/time (back-up) battery's service life is about 5 years. If the date/time is reset when the battery is replaced, replace the back-up battery with a new CR2025 lithium battery as described below.

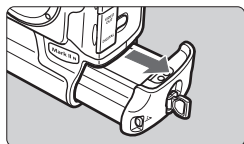

## 1 Set the <OFF> switch to <OFF> and remove the battery pack.

- The back-up battery is on the ceiling of the battery compartment.

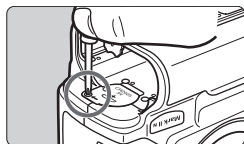

## 2 Remove the back-up battery cover.

- Use a small Philips screwdriver.
- As shown in the diagram, loosen the screw to remove the cover.
- Be careful not to lose the screw.



## 3 Remove the battery.

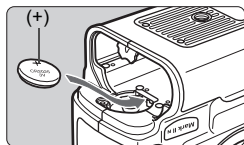

## 4 Install a new back-up battery.

- The plus side of the battery must face up.

## 5 Attach the cover.

- Install the battery and turn the <OFF> switch to <ON>. The date/time will be displayed on the LCD monitor. Set the date/time.

## **MENU** Cleaning the CMOS sensor

The image sensor is like the film in a film camera. If any dust adheres on the image sensor, it may show up as a dark speck on the images. To avoid this, detach the lens and follow the procedure below to clean the image sensor.

Using the DC Coupler Kit DCK-E1 (p.27) is recommended. If you use a battery, make sure the battery level is sufficient.

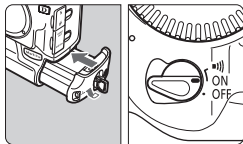

- 1 Install the DC Coupler or a battery and turn the <ON> switch to <ON>.**



- 2 Select [Sensor cleaning].**
  - Select the <fT2> tab.
  - Hold down the <SELECT> button and turn the <DIAL> dial to select [Sensor cleaning]. Then let go of the <SELECT> button.



- 3 Select [OK].**
  - Hold down the <SELECT> button and turn the <DIAL> dial to select [OK]. Then let go of the <SELECT> button.
  - ▶ The LCD monitor will turn off.

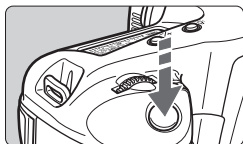

- 4 Press the shutter button completely.**
  - ▶ The mirror will lock up and the shutter will open.



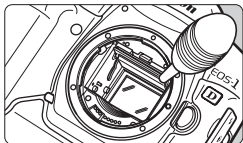

## 5 Clean the image sensor.

- Use a rubber blower to carefully blow away any dust, etc., on the surface of the image sensor.

## 6 Exit the sensor cleaning.

- Turn the <☺> switch to <OFF>.
- ▶ The camera will turn off, the shutter will close, and the mirror will go back down.
- Set the <☺> switch to <ON>. The camera will be ready to shoot.



- **During the sensor cleaning, never do any of the following that would turn off the power. If the power is cut off, the shutter will close and it may damage the shutter curtains and image sensor.**
  - Turn the <☺> switch to <OFF>.
  - Open the memory card slot cover.
  - Remove the battery.
- The surface of the image sensor is extremely delicate. Be very careful when cleaning the sensor.
- Be sure not to turn off the camera while cleaning the image sensor. If the power is turned off, the shutter will close and the shutter curtains might be damaged.
- Use a blower not attached with a brush. A brush can scratch the sensor.
- Do not insert the blower tip inside the camera beyond the lens mount. If the power goes out, the shutter curtains will close and the blower tip may damage them.
- Never use canned air or gas to clean the sensor. The blowing force can damage the sensor or the spray gas can freeze on the sensor.

If you cannot remove all of the dust, consult a Canon Service Center.

# Attaching the Neck Strap and Hand Strap

## Attaching the Neck Strap

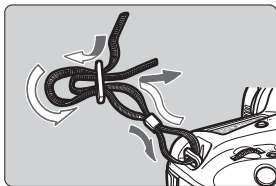

## Attaching the Hand Strap (optional)

1

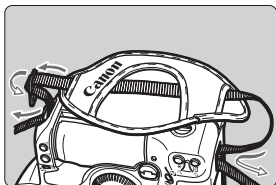

4

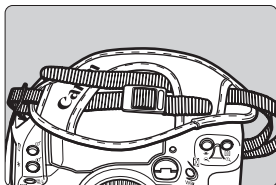

2

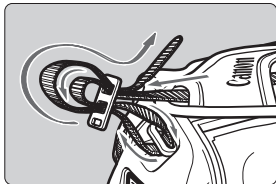

5

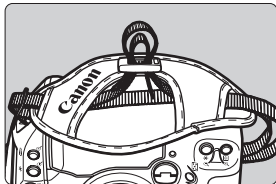

3

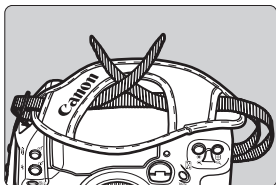

6

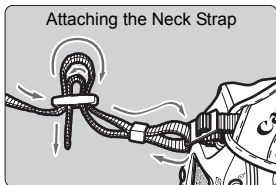

After attaching the strap, pull it at the buckle to take up the slack and to make sure it does not loosen.

# 2

## Image Settings

---

This chapter explains the settings for shooting digital images: Image-recording quality, ISO speed, white balance, color space, and Picture Style.

## **MENU** Setting the Image-recording Quality

You can select the image size (recorded pixels) and JPEG quality (compression rate). The simultaneous recording of RAW and JPEG images can be selected when you select the image size.

### Select the Image Size

Except for <RAW>, high-quality JPEGs will be recorded. <RAW> images will require processing with the software provided. **RAW + S/ M2/M1/L** modes record RAW and JPEG images simultaneously.

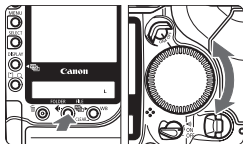

### Selecting the Image Size

- Hold down the <⏏> button and turn the <⌚> dial to select the desired image size. Then let go of the <⏏> button.

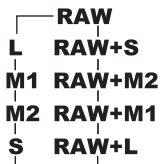

### Image Size Guide

Image Size (Approx. megapixels recorded)	Image Type	Print Size
<b>L</b> (Large)	JPEG	A3 or larger
<b>M1</b> (Medium1)		A4 or larger
<b>M2</b> (Medium2)		A5 - A4
<b>S</b> (Small)		A5 or smaller
<b>RAW</b> (RAW)	RAW	A3 or larger

- JPEG images will have the “jpg” extension, and RAW images will have the “cr2” extension.
- For simultaneous RAW+JPEG image recordings, the same image will be saved as a RAW (cr2) and JPEG (jpg) having the same file number in the same folder.
- The JPEG image can be used for direct printing and print ordering (DPOF).
- If you select **L**, **M1**, **M2**, or **S**, <JPEG> will be displayed in the viewfinder on the right. (Except for RAW and JPEG simultaneous recordings.)

## About the RAW

The RAW assumes that the image will undergo post-processing with a personal computer. Special knowledge is required, but you can use the bundled software to obtain the desired effect.

< **RAW** > images are processed according to the white balance and Picture Style set at the time of shooting.

Image processing refers to adjusting the RAW image's white balance, contrast, etc. , to create the desired image.

Note that direct printing and print ordering (DPOF) will not work with RAW images.

### Image File Size and Memory Card Capacity

Image Size	File Size (Approx. MB)	Possible Shots	Max. Burst
<b>L</b>	3.2	139	48
<b>M1</b>	2.6	175	59
<b>M2</b>	1.9	229	77
<b>S</b>	1.1	396	135
<b>RAW</b>	7.9	47	22
<b>RAW + L</b>	–	34	19
<b>RAW + M1</b>	–	36	19
<b>RAW + M2</b>	–	38	19
<b>RAW + S</b>	–	42	19

- The number of possible shots and maximum burst apply to a Canon 512MB memory card.
- The single image size, number of possible shots, and maximum burst during continuous shooting are based on Canon's testing criteria (JPEG quality: 8, Picture Style: Standard, ISO 100, etc. ). The actual file size and number of possible shots will depend on the subject, JPEG quality, shooting mode, ISO speed, Picture Style, etc.
- With memory cards featuring high-speed writing, the maximum burst may be higher than the figures in the table above.
- On the top LCD panel, you can check the remaining number of shots the memory card can record.
- The maximum burst for continuous shooting can be displayed up to 99 in the viewfinder.

## Setting the JPEG Quality (Compression rate)

You can set the recording quality for the **L/M1/M2/S** modes.

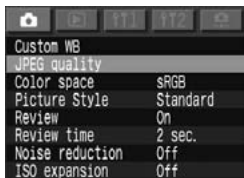

### 1 Select [JPEG quality].

- Select the <📷> tab.
- Hold down the <SELECT> button and turn the <🌀> dial to select the desired [JPEG quality]. Then let go of the <SELECT> button.

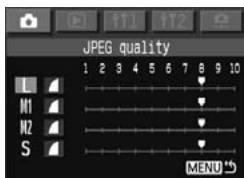

### 2 Select the image size.

- Hold down the <SELECT> button and turn the <🌀> dial to select the desired image size (**L/M1/M2/S**). Then let go of the button.



### 3 Set the desired recording quality (compression rate).

- Hold down the <SELECT> button and turn the <🌀> dial to select the desired [JPEG quality] (compression rate). Then let go of the button.
- The larger the number, the higher the quality will be (lower compression).

- The higher the recording quality (compression rate), the fewer the number of possible shots will be. On the other hand, the lower the recording quality (compression rate), the higher the number of possible shots will be.
- JPEG quality levels 1 to 5 are indicated by <▶>, and levels 6 to 10 are indicated by <▲>.

# Setting the ISO Speed

The ISO speed is a numeric indication of the sensitivity to light. A higher ISO speed number indicates a higher sensitivity to light. Therefore, a high ISO speed is suited for low light and moving subjects. However, the image may look more coarse with noise, etc. On the other hand, a low ISO speed is not suited for low light or action shots, but the image will look finer.

The camera can be set between ISO 100 and 1600 in 1/3-stop increments.



## 1 Hold down the <AF> and <AE-L/AF-L> buttons simultaneously.

- ▶ The current ISO speed will be displayed on the LCD panel.

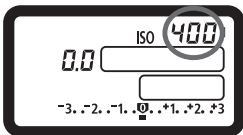

## 2 Turn the <ISO> dial.

- While looking at the LCD panel or viewfinder, turn the <ISO> dial until the desired ISO speed appears, then let go of the buttons.
- ▶ The ISO speed will be set.



- At higher ISO speeds and higher ambient temperatures, the image will have more noise.
- High temperatures, high ISO speeds, or long exposures may cause irregular colors in the image.

## ISO speed extension



Under the <camera> tab, set **[ISO expansion]** to <On> to enable ISO 50 or 3200 to be set. When set, ISO 50 is indicated by L and ISO 3200 by H.

## MENU Selecting a Picture Style

By selecting a Picture Style, you can obtain the desired image effects. You can also adjust the settings of each Picture Style to obtain custom image effects.



### 1 Select [Picture Style].

- Select the <📷> tab.
- Hold down the <SELECT> button and turn the <🌀> dial to select [Picture Style]. Then let go of the button.
- ▶ The Picture Style selection screen will appear.

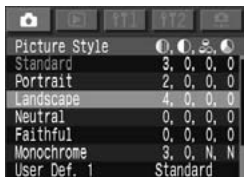

### 2 Select the style.

- Hold down the <SELECT> button and turn the <🌀> dial to select the desired style. Then let go of the button.

## Picture Style Effects

### Standard

The image looks vivid, sharp, and crisp.

### Portrait

For nice skin tones. The image looks slightly sharp and crisp.

By changing the [Color tone] (p.58), you can adjust the skin tone.

### Landscape

For vivid blues and greens, and very sharp and crisp images.

### Neutral

For natural colors and subdued images. No sharpness is applied.

### Faithful

When the subject is photographed under a color temperature of 5200K, the color is adjusted colorimetrically to match the subject's color. No sharpness is applied.



## Monochrome

You can take black-and-white photos.



- To obtain natural-looking, black-and-white images, set a suitable white balance.
- JPEG black-and-white images captured with the **[Monochrome]** setting cannot be converted into color images even with image-editing software.



- RAW images captured with the **[Monochrome]** setting can be converted into color images with the bundled software.
- When **[Monochrome]** is selected, **<B/W>** will appear on the rear LCD panel.

## User Def. 1-3

You can register your own Picture Style settings in **[Detail set.]** (p.61). If any User Defined Picture Style has not been registered, the shot will be taken with the same settings as the **[Standard]**.

## Detail set.

You can change and modify the parameters (such as **[Sharpness]**) of each style from their default settings. You can also select a base Picture Style, adjust its parameters to suit your preferences and register it in User Defined 1 to 3 as your own Picture Style.

## About the Picture Style selection screen

The symbols on the upper right of the Picture Style selection screen refer to parameters such as **[Sharpness]**, **[Contrast]** etc. The numerals indicate the settings of parameters for each Picture Style.

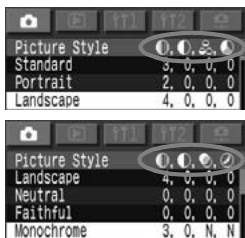

## Symbols

	Sharpness
	Contrast
	Color saturation
	Color tone
	Filter effect (Monochrome)
	Color toning (Monochrome)

## MENU Customizing the Picture Style

You can customize the Picture Style by changing the individual parameters like **[Sharpness]** and **[Contrast]** from their default settings to suit your preferences. To customize **[Monochrome]**, see page 59.

### 1 Select **[Detail set.]**.

- Follow step 2 on page 56 to select **[Detail set.]**.
- ▶ The Detail set. screen will appear.



### 2 Select the style.

- Hold down the <SELECT> button and turn the <DIAL> dial to select a style except **[Monochrome]** and **[User Def. 1/2/3]**, then let go of the button.



### 3 Select the parameter.

- Hold down the <SELECT> button and turn the <DIAL> dial to select a parameter like **[Contrast]**, then let go of the button.



### 4 Set the desired setting.

- Hold down the <SELECT> button and turn the <DIAL> dial to set the desired setting, then let go of the button.
- Press the <MENU> button to save the setting. The Picture Style selection screen will reappear.

## Parameters and Their Settings

Sharpness	[0] : Less sharp outline	[+7] : Sharp outline
Contrast	[-4] : Low contrast	[+4] : High contrast
Color saturation	[-4] : Low saturation	[+4] : High saturation
Color tone	[-4] : Reddish skin tone	[+4] : Yellowish skin tone

## Monochrome Adjustment

For Monochrome, you can also set **[Filter effect]** and **[Toning effect]** in addition to **[Sharpness]** and **[Contrast]**.

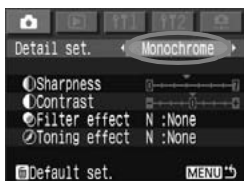

### 1 Select **[Monochrome]**.

- Follow step 2 on page 58 to select **[Monochrome]**.

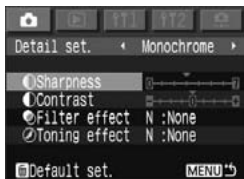

### 2 Select the parameter.

- Hold down the <SELECT> button and turn the <◂> dial to select a parameter like **[Sharpness]**, then let go of the button.
- To set the **[Filter effect]** or **[Toning effect]**, see page 60.

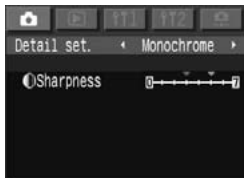

### 3 Set the desired setting.

- Hold down the <SELECT> button and turn the <◂> dial to set the desired setting, then let go of the button.
- Press the <MENU> button to save the setting. The Picture Style selection screen will reappear.



- With the Detail set screen displayed, you can reset all the Picture Styles to their default settings by pressing the <⌫> button.
- Any settings different from the default will be displayed in blue.
- To shoot with the Picture Style you modified, follow step 2 on page 56 to select the Picture Style and then shoot.

## Filter effects

The same effect as using filters with black-and-white film can be obtained with digital images. A color can be brightened by using a filter having a similar or same color. At the same time, the complementary colors will be darkened.

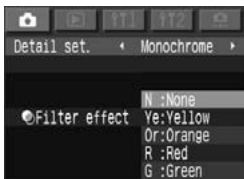

Filter	Sample effects
N: None	Normal black-and-white image with no filter effects.
Ye: Yellow	The blue sky will look more natural, and the white clouds will look clearer.
Or: Orange	The blue sky will look slightly darker. The sunset will look more brilliant.
R: Red	The blue sky will look quite dark. Fall leaves will look crisper and brighter.
G: Green	Skin tones and lips will look fine. Tree leaves will look crisper and brighter.

 Setting the **[Contrast]** to the plus side will make the filter effect more pronounced.

## Toning Effect

When color toning is set, color toning will be applied to the captured black-and-white image before being recorded to the memory card. It can make the image look more impressive.

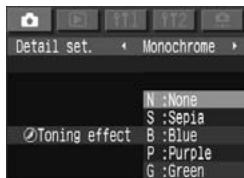

The following can be selected:  
**[N:None] [S:Sepia] [B:Blue] [P:Purple]**  
**[G:Green]**

## MENU Registering the Picture Style

You can select a base Picture Style such as [Portrait] or [Landscape], adjust its parameters to suit your preferences and register it in User Defined 1 to 3. You can also select a Picture Style already set with the provided software.

### 1 Select [Detail set.].

- Follow step 2 on page 56 to select [Detail set.].
- ▶ The Detail set. screen will appear.

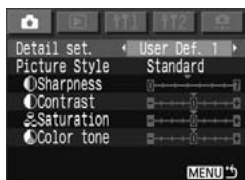

### 2 Select [User Def. 1/2/3]

- Hold down the <SELECT> button and turn the <◉> dial to select [User Def. 1/2/3], then let go of the button.



### 3 Select the base Picture Style.

- Press the <SELECT> button, then let go of the button.
- Hold down the <SELECT> button and turn the <◉> dial to select the base Picture Style, then let go of the button.
- If you have set your own Picture Style with the software provided, select it in this step.

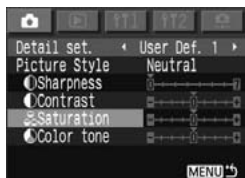

### 4 Select the parameter.

- Hold down the <SELECT> button and turn the <◉> dial to select a parameter like [Saturation], then let go of the button.



## 5 Set the desired setting.

- Hold down the <SELECT> button and turn the <DIAL> dial to set the desired setting, then let go of the button.
- Press the <MENU> button to register the new Picture Style. The Picture Style selection screen will then reappear.
  - ▶ The base Picture Style will be displayed on the right of **[User Def. 1/2/3]**.
  - ▶ The name of the Picture Style having any modified settings (different from the default) registered in the **[User Def. 1/2/3]** will be displayed in blue.
- To shoot with the registered Picture Style, follow step 2 for selecting **[User Def. 1/2/3]** on page 56.

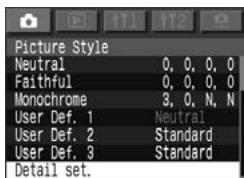

### Changing the Picture Style setting inadvertently

If a User Defined Picture Style is already registered with your own Picture Style, following the procedure on page 61 up to step 3 for that User Defined Picture Style will revert it back to the default setting.

If you do not want to change the User Defined Picture Style, do not repeat this procedure.

## MENU Setting the Color Space

The color space refers to the range of reproducible colors. With this camera, you can set the color space for captured images to sRGB or Adobe RGB. For general shooting, sRGB is recommended.

### 1 Select [Color space].

- Select the <📷> tab.
- Hold down the <SELECT> button and turn the <🌀> dial to select [Color space]. Then let go of the button.



### 2 Set the desired color space.

- Hold down the <SELECT> button and turn the <🌀> dial to select [sRGB] or [Adobe RGB]. Then let go of the button.

### About Adobe RGB

This is mainly used for commercial printing and other industrial uses. This setting is not recommended if you do not know about image processing, Adobe RGB, and Design rule for Camera File System 2.0 (Exif 2.21).

Since the image will look very subdued with sRGB personal computers and printers not compatible with Design rule for Camera File System 2.0 (Exif 2.21), post-processing of the image with software will be required.



- If the captured image was shot in the Adobe RGB color space, the first character in the file name will be an underscore (\_).
- The ICC profile is not appended. The ICC profile is explained in the Software Instruction Manual (PDF).

## MENU Selecting the White Balance

Normally, the <AWB> setting will set the optimum white balance automatically. If natural-looking colors cannot be obtained with <AWB>, you can set the white balance manually to suit the respective light source.

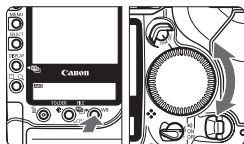

### Select the white balance setting.

- Hold down the <WB> button and turn the <◉> dial to select the desired white balance. Then let go of the button.

AWB

Display	Mode	Color temperature (Approx. K)
AWB	Auto	3000 - 7000
	Daylight	5200
	Shade	7000
	Cloudy, twilight, sunset	6000
	Tungsten	3200
	White fluorescent light	4000
	Flash	6000
	Custom*	2000 - 10000
K	Color temperature	2800 - 10000
PC-1, PC-2, PC-3	Personal white balance**	-

\* To set the optimum white balance for the specific lighting type. (p.65)

\*\* Register it with the bundled software. (Not displayed if not registered in the camera.)

### About White Balance

The three RGB (red, green, and blue) primary colors exist in the light source in varying proportions depending on the color temperature. When the color temperature is high, there is more blue. And when the color temperature is low, there is more red.

To the human eye, a white object looks white regardless of the type of lighting. With a digital camera, the color temperature can be adjusted with software so that the colors in the image look more natural. The subject's white color is used as the criteria for adjusting the other colors. The camera's <AWB> setting uses the CMOS sensor for auto white balance.



## MENU Custom White Balance

With custom white balance, you shoot a white object that will serve as the basis for the white balance setting. By selecting this image, you import its white balance data for the white balance setting.

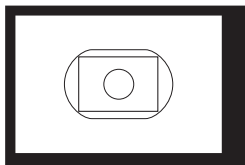

### 1 Photograph a white object.

- Make sure the plain, white subject fills the entire center spot metering circle.
- Set the lens focus mode switch to <MF>, then focus manually. (p.90)
- Set any white balance setting. (p.64)
- Shoot the white object so that a standard exposure is obtained. If it is underexposed or overexposed, a correct white balance setting might not be obtained.

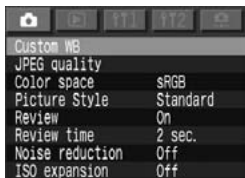

### 2 Select [Custom WB].

- Select the <CAMERA> tab.
- Hold down the <SELECT> button and turn the <DISP/NAV> dial to select [Custom WB]. Then let go of the button.
  - ▶ The 9-image index display will appear.



### 3 Select the image.

- Hold down the <SELECT> button and turn the <DISP/NAV> dial to select the image you shot in step 1. Then let go of the button.



#### 4 Import the white balance data.

- Hold down the <SELECT> button and turn the <DISP> dial to select [OK]. Then let go of the <SELECT> button.
- ▶ The image's white balance data will be imported.

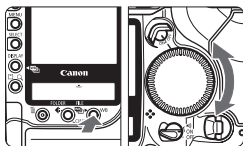

#### 5 Select <CAM>.

- Hold down the <WB> button and turn the <DISP> dial to select <CAM>. Then let go of the <WB> button.
- ▶ The custom white balance will be set.



 If an image was captured while the Picture Style was set to **[Monochrome]** (p.57), it cannot be selected in step 3.

 Instead of a white object, an 18% gray card (commercially available) can produce a more accurate white balance.

# Setting the Color Temperature

You can numerically set the white balance's color temperature.

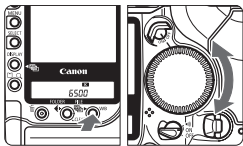

## 1 Select <K> for the white balance.

- Hold down the <WB> button and turn the <☀> dial to select <K>.

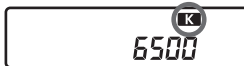

## 2 Set the color temperature.

- Hold down the <WB> button and turn the <☀> dial to set the desired color temperature. Then let go of the button.
- The color temperature can be set from 2800K to 10000K in 100K increments.



- When setting the color temperature for an artificial light source, set white balance correction (magenta or green) as necessary.
- If you want to set <K> to the reading taken with a color temperature meter, take test shots and adjust the setting to compensate for the difference between the color temperature meter's reading and the camera's color temperature reading.

# White Balance Correction

You can correct the color temperature for the white balance setting. This adjustment will have the same effect as using a color temperature conversion or color compensating filter. Each color can be corrected to one of nine levels.

Users familiar with using color temperature conversion or color compensating filters will find this feature handy.

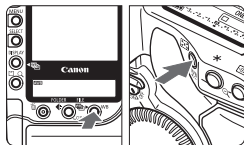

## 1 Hold down the <WB> button and press the <WB> button.

- Hold down the <WB> button. You can let go of the <WB> button.

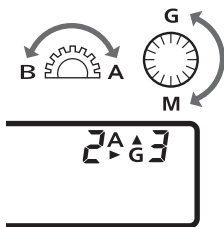

## 2 Hold down the <WB> and turn the <WB> or <WB> dial.

- The <WB> dial adjusts blue (B) and amber (A), and the <WB> dial adjusts magenta (M) and green (G).
- You can adjust both blue (B)/amber (A) and magenta (M)/green (G).
- To cancel white balance correction, return the setting to "0".

- During the adjustment, <WB> will be displayed in the viewfinder.
- One level of the blue/amber correction is equivalent to 5 mireds of a color temperature conversion filter. (Mired: measuring unit indicating the density of a color temperature conversion filter.)
- You can also set white balance bracketing and AEB shooting in addition to the white balance correction.

# White Balance Auto Bracketing

With just one shot, three images having a different color tone can be recorded simultaneously. Based on the white balance mode's standard color temperature, the image will be bracketed with a blue/amber bias or magenta/green bias. This is called white balance bracketing. It can be set up to  $\pm 3$  levels in single-level increments.

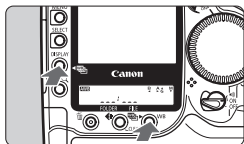

## 1 Hold down the <WB> button and press the <DISPLAY> button.

▶ The rear LCD panel will be as follows:

- **Hold down the <DISPLAY> button.**  
You can let go of the <WB> button.

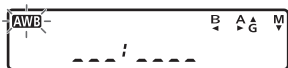

## 2 Hold down the <DISPLAY> and turn the <gear> or <dial> dial.

- Turn the <gear> dial to set the blue (B) or amber (A) bracketing amount or turn the <dial> dial to set the magenta (M) or green (G) bracketing amount.
- The blue (B) or amber (A) bracketing amount cannot be set together with the magenta (M) or green (G).

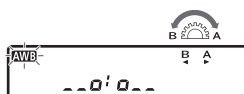

B(-) ← 0 → (+) A

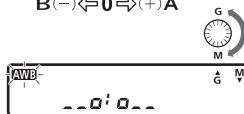

M(-) ← 0 → (+) G

--- : OFF  
- 0 - :  $\pm 1$  level  
- 0 0 - :  $\pm 2$  levels  
- 0 0 0 - :  $\pm 3$  levels

- ▶ The number of remaining shots displayed on the LCD panel will be one-third the normal count.

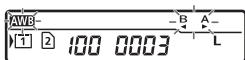

### 3 Take the picture.

- ▶ Three bracketed images will be recorded in the memory card in the following sequence: standard color temperature, decreased color temperature, and increased color temperature.
- To cancel white balance bracketing, return the setting to < \_ \_ \_ ; \_ \_ \_ >.



- One level of the blue/amber correction is equivalent to 5 mireds of a color temperature conversion filter.
- You can also set white balance correction and AEB shooting in addition to the white balance bracketing. If you set AEB in combination with white balance bracketing, a total of nine images will be recorded for a single shot.
- During continuous shooting, the number of images recorded will be three times the number of shots taken.
- Since three images are recorded for one shot, the memory card will take longer to record the shot.

## Setting the Folder and Memory Card

You can create and select folders.

If you have both the CF card and SD card installed in the camera, you can select which card to save captured images or use both cards to save identical images. For RAW+JPEG images recorded simultaneously, you can save the RAW images separately on one card and JPEG images on the other.

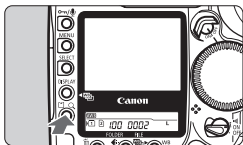

### Set the camera to the folder mode.

- With the LCD monitor turned off, press the  $\langle \square \rangle$  button. (You can also hold down the  $\langle \text{DISPLAY} \rangle$  button and turn the  $\langle \odot \rangle$  dial to select  $\langle \blacksquare \rangle$ .)

### Creating a New Folder

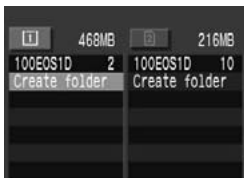

- Hold down the  $\langle \text{SELECT} \rangle$  button and turn the  $\langle \odot \rangle$  dial to select **[Create folder]**. Then let go of the button.
- ▶ The Create folder screen will appear.
- Hold down the  $\langle \text{SELECT} \rangle$  button and turn the  $\langle \odot \rangle$  dial to select **[OK]**. Then let go of the button. A new folder will be created.



- The left  $\langle \text{1} \rangle$  tab shows the folders in the CF card, and the right  $\langle \text{2} \rangle$  tab shows the folders in the SD card.
- The number next to the  $\langle \text{1} \rangle$  and  $\langle \text{2} \rangle$  tabs indicate the respective card's remaining capacity.
- "100EOS1D" is the folder No. and the number on the right is the number of images contained in the folder.

 A folder cannot be created beyond folder No. 999.

### Creating Folders with a Personal Computer

With the memory card open on the screen, create a new folder named “Dcim.”

Open the Dcim folder and create as many folders as necessary to save and organize your images.

The folder names must start with three digits from 100 to 999 followed by five letters, like **100ABC\_D**. The five letters can be a combination of upper or lower case letters from A to Z and an underscore. There can be no spaces in the folder name. Also, if there are folder numbers with the same three-digit number (regardless of the letters) such as “**100ABC\_C**” and “**100ABC\_D**”, the camera will not recognize the folders.

### Selecting a Folder

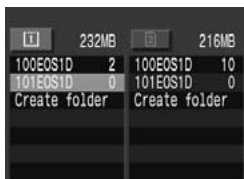

- Hold down the <SELECT> button and turn the <DIAL> dial to select a folder. Then let go of the button.
- ▶ The folder will be selected.

### Selecting the Memory Card

Select the memory card to be used for image recording, playback, and erasing.

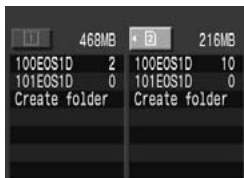

- Hold down the <TAB> button and turn the <DIAL> dial to select the memory card. Then let go of the button.
- The left [TAB] tab is the CF card, and the right [FOLDER] tab is the SD card.



## Recording Identical Images on Both Cards (Dual image recording)

You can record the same image on both the CF card and SD card.

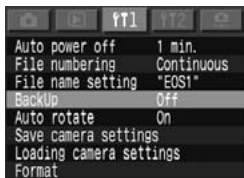

### 1 Select [BackUp].

- Select the <fT1> tab.
- Hold down the <SELECT> button and turn the <◉> dial to select [BackUp]. Then let go of the button.



### 2 Select [**1-2**] or [**<-2**].

- Hold down the <SELECT> button and turn the <◉> dial to select [**1-2**] or [**<-2**], then let go of the button. (The [**1-2**] and [**<-2**] icons indicate which card is to display the image for the image review immediately following image capture. [**1-2**] will display the image saved in the CF card, and [**<-2**] will display the image saved in the SD card.)



### 3 Select [Record same image on both **1** **2**].

- Hold down the <SELECT> button and turn the <◉> dial to select [Record same image on both **1** **2**], then let go of the button.
- When you shoot, the same image will be recorded in both the CF card and SD card.

## Record RAW+JPEG Images Separately (RAW+JPEG separate recording)

When the image size is set to **RAW + L/M1/M2/S** (RAW+JPEG), you can save the RAW image to the CF card (1) and the JPEG image to the SD card (2) (or vice versa).



### 1 Select [(1): RAW (2): JPEG] or [(1): JPEG (2): RAW].

- Follow step 3 on page 73 to select [(1): RAW (2): JPEG] or [(1): JPEG (2): RAW].

### 2 Set the image size to RAW+JPEG. (p.52)



- ❗ When shooting with “Dual image recording” or “RAW+JPEG separate recording” set, make sure the CF card and SD card both have enough space remaining.
- Before shooting, check that the following is displayed on the rear LCD panel:
 

“Dual image recording”	(1) (2)	“RAW+JPEG separate recording”	(1) (2)	(1) (2)
			RAW	RAW

- 📁 If “RAW+JPEG separate recording” is set and the image size is not set to RAW+JPEG, it will be the same as “Dual image recording”.
- When “Dual image recording” or “RAW+JPEG separate recording” is set, the images will be saved in the respective memory cards under the same file number in the same-numbered folder.
- To make it easier to find the images, creating a new empty folder to save captured images is recommended.
- The number of remaining shots displayed on the top LCD panel will be based on the memory card having less remaining capacity.
- When **[BackUp]** is set, a folder having the same folder number might be created automatically in both the CF card and SD card.
- If either one of the memory cards becomes full, shooting will not be possible.
- You cannot move or copy images between the two cards.

## MENU Setting the File Name

The factory default sets the file name with four camera-unique, alphanumeric characters followed by the file number (p.76). You can customize these first four alphanumeric characters in the file name.

(Example)

**5F9Z0001.jpg**

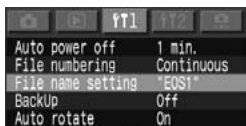

### 1 Select [File name setting].

- Select the <F11> tab.
- Hold down the <SELECT> button and turn the <DIAL> dial to select [**File name setting**]. Then let go of the button.

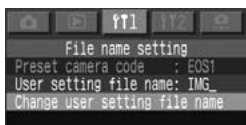

### 2 Select [Change user setting file name].

- Hold down the <SELECT> button and turn the <DIAL> dial to select [**Change user setting file name**]. Then let go of the button.

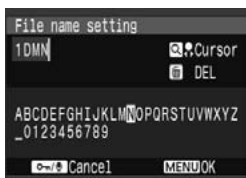

### 3 Enter four alphanumeric characters.

- Hold down the <Q> button and turn the <DIAL> dial to move the cursor to the right of the character to be deleted. Press the <DEL> button to delete the character.
- Hold down the <SELECT> button and turn the <DIAL> dial to select the desired alphanumeric character. Then let go of the button to enter.
- Enter any four alphanumeric characters and press the <MENU> button.
- ▶ The File name setting screen will reappear.

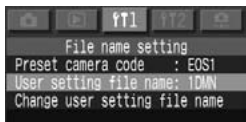

### 4 Select [User setting file name: xxxx].

- Hold down the <SELECT> button and turn the <DIAL> dial to select [**User setting file name: xxxx**]. Then let go of the button.

! The first character cannot be an underscore (\_).

## MENU File Numbering Methods

The file number is like the frame number on a roll of film. It can start counting in one of three different ways: [**A-Reset**], [**Continuous**], and [**M-Reset**]. The images you take are automatically assigned a file number from 0001 to 9999. The images are saved in the selected folder.

### 1 Select [File numbering].

- Select the <Fn1> tab.
- Hold down the <SELECT> button and turn the <DIAL> dial to select [**File numbering**]. Then let go of the button.

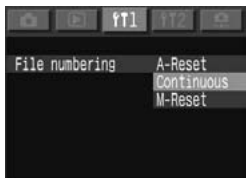

### 2 Select the desired setting.

- Hold down the <SELECT> button and turn the <DIAL> dial to select the desired setting. Then let go of the button.

## Auto Reset (A-Reset)

Each time you replace the memory card, the file numbering will be reset to the first file number (**XXXX0001**). Since the file number starts from **0001** in each memory card, you can organize images according to memory cards.

### File numbering after changing the folder

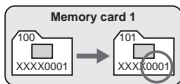

### File numbering after replacing the memory card

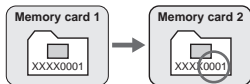

## Continuous

The file numbering continues in sequence even after you replace the memory card. This prevents images from having the same file number, so image management with a personal computer is easier.

### File numbering after changing the folder

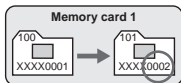

### File numbering after replacing the memory card

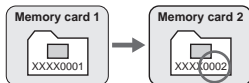

 If the memory card in use has a DCIM folder, the file numbering might continue from the last image saved in the folder.

## Manual Reset (M-Reset)

This creates a new folder automatically and resets the file number to **XXXX0001**. Images captured thereafter are saved in this new folder. The file numbering method (Auto reset or Continuous) that was in effect before the manual reset will continue to take effect.

## MENU Noise Reduction of Long Exposures

For long exposures 1 sec. or longer, noise reduction can be applied.

### 1 Select [Noise reduction].

- Select the <📷> tab.
- Hold down the <SELECT> button and turn the <🕒> dial to select [**Noise reduction**]. Then let go of the button.

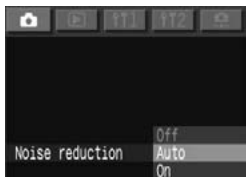

### 2 Select the desired setting.

- Hold down the <SELECT> button and turn the <🕒> dial to select the desired setting. Then let go of the button.

<b>Off</b>	Noise reduction is not applied.
<b>Auto</b>	Noise reduction is applied automatically on long exposures 1 sec. or longer if noise typical to long exposures is detected. This setting is effective in most cases.
<b>On</b>	Noise reduction is applied automatically to all long exposures 1 sec. or longer. This setting is effective for noise that cannot be detected or reduced with the [ <b>Auto</b> ] setting.

⚠ At the [**Auto**] or [**On**] setting, the maximum burst during continuous shooting will be slightly lower.

🕒 The noise reduction process may require the same amount of time as the exposure. As long as the viewfinder display indicates the maximum burst as 1 or higher, shooting can continue.

# 3

## Autofocus and Drive Modes

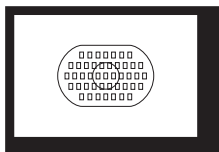

The Area AF ellipse has 45 AF points. By selecting a suitable AF point, you can shoot with autofocus while maintaining the desired subject framing. You can also set the AF mode to suit the subject or obtain the desired effect.



First set the <AF mode> switch and <AF-ON> switch to <ON>.

## Selecting the AF Mode

**1** Set the lens focus mode switch to <AF>.

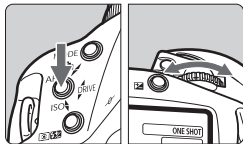

**2** Set the AF mode.

- Hold down the <AF> button and turn the <☀> dial to select the desired AF mode on the top LCD panel. Then let go of the button.

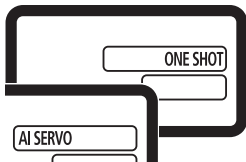

### One-Shot AF for Still Subjects

Pressing the shutter button halfway activates the autofocus and achieves focus once.

- ▶ The AF point which achieves focus flashes briefly and the focus confirmation light <●> in the viewfinder lights at the same time. The exposure is also set.

### AI Servo AF for Moving Subjects

While you press the shutter button halfway, the camera continues to focus the subject approaching or moving away from the camera.

- This AF mode is for moving subjects when the focusing distance keeps changing.
- The exposure is set at the moment the picture is taken.



## Focusing an Off-Center Subject

To focus a peripheral subject not covered by the Area AF ellipse, follow the procedure below. This technique is called focus lock.

Focus lock works only in the One-Shot AF mode.

- 1 Aim the Area AF or AF point over the subject and press the shutter button halfway to focus.**
- 2 Keep pressing the shutter button halfway and recompose the picture as desired.**
- 3 Take the picture.**



- If focus cannot be achieved, the focus confirmation light <●> in the viewfinder will blink. If this occurs in the One-Shot AF mode, the picture cannot be taken even if the shutter button is pressed fully. Recompose the picture and try to focus again. Or see “When Autofocus Fails (Manual Focusing)” (p.89).
- In the AI Servo AF mode when the AF point selection is automatic, the camera first uses the center AF point to focus. During autofocusing, if the subject moves away from the center AF point, focus tracking continues as long as the subject is covered by the Area AF ellipse. The active AF point does not light.
- In the AI Servo AF mode, when focus is achieved, the viewfinder’s focus confirmation light does not light and the beeper does not sound.

# Selecting the AF Point

## Automatic AF Point Selection

From among the 45 AF points, the camera selects the AF point automatically to suit the subject.

## Manual AF Point Selection

(One of three groups of selectable AF points can be used)

1. You can select one of the 45 AF points manually.
  2. You can select one of 11 AF points manually. (C.Fn-13-1, 2)
  3. You can select one of 9 AF points manually. (C.Fn-13-3, 4)
- \* Selection methods 2 and 3 are enabled by setting C.Fn-13. (p.166)  
Set Custom Functions with **MENU** <  >.

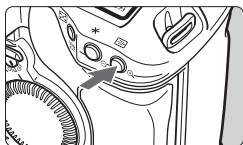





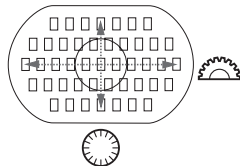

**1** Press the  button. (ⓐ6)

Manual selection with 45 AF points



**2** Select an AF point.

- To select a horizontal AF point, turn the  dial.
- To select a vertical AF point, turn the  dial.
- If all the peripheral AF points light up, automatic AF point selection will take effect.
- When you press the shutter button halfway, the camera will be ready to shoot.

-  ● To select a vertical AF point, you can also press the  button, then hold down the  button and turn the  dial.
- If two AF points () light up, both AF points will be used for autofocusing. If you then select the left or right AF point, only that AF point will be active.

## Manual selection limited to 11 AF points **C.Fn-13-1, 2**

(p.166)

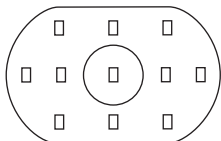

- Since the selectable AF points are limited to 11, you can better concentrate on framing the subject.
- The AF point selection procedure is the same as explained in steps 1 and 2.

## Manual selection limited to 9 AF points **C.Fn-13-3, 4** (p.166)

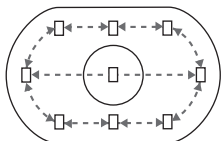

- The center AF point and 8 peripheral AF points are selectable.
- Selecting a horizontal AF point is the same as explained in steps 1 and 2. Selecting an AF point beyond a peripheral AF point will set the automatic selection mode.
- To select a peripheral AF point, press the button and turn the dial.





With C.Fn-13-1/2/3/4, all 45 AF points will be available for automatic selection.

# Registering and Switching the AF Point

By registering the AF point you often use, you can switch to it instantly. Any of the 45 AF points can be registered. Only one AF point can be registered.



## Registering an AF Point

### 1 Select the AF point to be registered.

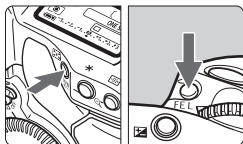
- Press the  and turn the  or  dial.



### 2 Register the selected AF point.

- Hold down the  button and press the  button.
- ▶ The AF point will be registered.
- During AF point registration and switching, the LCD panel will display the following:

Automatic AF point selection

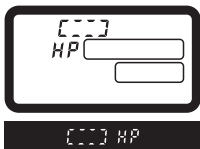



Off-center AF point







Center AF point



- When using a Speedlite and spot metering, first press the  button. If you press the  button first, the AF point selection will be canceled.
- An AF point cannot be registered if C.Fn-13-3/4 has been set to limit the selectable AF points to 9.

## Switching to the Registered AF Point

Normally, you press the  button and  button simultaneously to switch to the registered AF point. However, with C.Fn-18-1/2 (p.168), you can just press the  button to switch to the registered AF point. Set Custom Functions with **MENU** < >.

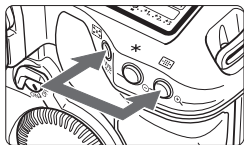

- (1) Press the  button and  button simultaneously.

- This is the default method.

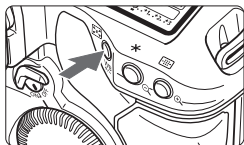

- (2) Press only the  button to switch to the registered AF point.

**C.Fn-18-1** (p.168)

- (3) Switch to the registered AF point only while pressing the  button.

**C.Fn-18-2** (p.168)

- When you release the  button, the camera will return to the original AF point.



- If you set or cancel C.Fn-13, the center AF point will become the registered AF point. This does not apply if you change C.Fn-13-1 to C.Fn-13-2 or vice versa.
- If C.Fn-18-1/2 and C.Fn-04-1/3 are also set, you can just press the  button to switch to the registered AF point and activate the autofocus at the same time.

## AF Point Activation Area **C.Fn-17**



C.Fn-17 can be set to expand the AF point's activation area to include the surrounding AF points. (C.Fn-17) (p.167)

Set Custom Functions with **MENU** <  >.

### • Expanding the activation area to 7 points **C.Fn-17-1** (p.167)

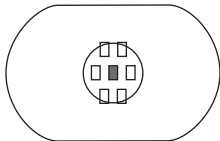
This larger activation area makes it easier to focus subjects moving erratically.



-  : Selected AF point
-  : AF points in expanded activation area

- The expanded AF point activation area is not displayed in the viewfinder.
- When focus is achieved in the One-Shot AF mode, the selected AF point and AF point(s) achieving focus will light.

### • Expanding the activation area to 7 or 13 AF points automatically **C.Fn-17-2** (p.167)

As shown below, the AF point activation area expands automatically to suit the lens focal length and AF mode. This is effective when the subject's movement is unpredictable.

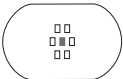
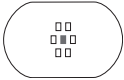
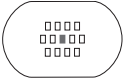
AF Mode	Lens Focal Length	
	Shorter than 200mm	200mm or longer
One-Shot AF	 <p>The AF activation area does not expand automatically.</p>	 <p>The activation area expands by 1 AF point</p>
AI Servo AF		

## AF Sensitivity and Lens' Maximum Aperture

The EOS-1D Mark II N's AF points are all horizontal-line sensitive. However, bright lenses with a large maximum aperture enable certain AF points to work as cross-type sensors for higher AF precision.

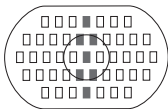

- (1) With lenses whose maximum aperture is  $f/2.8$  or larger, ■ the AF points highlighted in the diagram will work as cross-type sensors sensitive to both vertical and horizontal lines. The remaining 38 AF points will only be horizontal-line sensitive. The cross-type sensor's vertical-line sensitivity is about three times higher than its horizontal-line sensitivity.

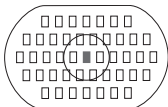

- (2) With the following L-series lenses whose maximum aperture is  $f/4$  or larger, the center AF point will be a cross-type sensor with or without an Extender attached. The remaining 44 AF points will only be horizontal-line sensitive (except with EF70-200mm  $f/2.8L$  USM + Extender EF1.4x or EF1.4x II).

- EF17-40mm  $f/4L$  USM
- EF28-80mm  $f/2.8-4L$  USM
- EF300mm  $f/4L$  USM
- EF300mm  $f/4L$  IS USM
- EF400mm  $f/4$  DO IS USM
- EF500mm  $f/4L$  IS USM
- EF600mm  $f/4L$  USM
- EF600mm  $f/4L$  IS USM
- EF70-200mm  $f/4$  L USM
- With Extender EF1.4x or EF1.4x II:
  - EF200mm  $f/2.8L$  USM
  - EF200mm  $f/2.8L$  II USM
  - EF300mm  $f/2.8L$  USM
  - EF300mm  $f/2.8L$  IS USM
  - EF400mm  $f/2.8L$  USM
  - EF400mm  $f/2.8L$  II USM
  - EF400mm  $f/2.8L$  IS USM
  - EF70-200mm  $f/2.8L$  IS USM
- With Extender EF2x or EF2x II:
  - EF135mm  $f/2L$  USM
  - EF200mm  $f/1.8L$  USM

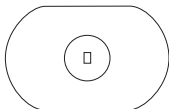

(3) With the following L-series lenses whose maximum aperture is f/8 or larger and attached with an Extender, AF will work with the center AF point (horizontal-line sensitive) only. AF will not work with the other AF points.

- With Extender EF1.4x or EF1.4x II:
  - EF400mm f/5.6L USM
  - EF500mm f/4.5L USM
  - EF100-400mm f/4.5-5.6L IS USM
- With Extender EF2x or EF2x II:
  - EF300mm f/4L USM
  - EF300mm f/4L IS USM
  - EF400mm f/4 DO IS USM
  - EF500mm f/4L IS USM
  - EF600mm f/4L USM
  - EF600mm f/4L IS USM
  - EF70-200mm f/4 L USM
- When you press the  button, the top LCD panel will show the display on the right.

-0-  
AF

 **With the EF70-200mm f/2.8L USM lens (without IS) attached with Extender EF1.4x or EF1.4x II, the center AF point will work as a cross-type sensor. Do not use autofocus with the other AF points because they may cause a focusing error.**



## When Autofocus Fails (Manual Focusing) ■

Autofocus can fail to achieve focus (the focus confirmation light <●> blinks) with certain subjects such as the following:

### Subjects difficult to focus

- (a) Low-contrast subjects  
Example: Blue sky, solid-color walls, etc.
- (b) Subjects in low light
- (c) Extremely backlit and reflective subjects  
Example: Car with a reflective body, etc.
- (d) Overlapping near and far objects  
Example: Animal in a cage, etc.
- (e) Repetitive patterns  
Example: Skyscraper windows, computer keyboards, etc.

In such cases, do one of the following:

- (1) Focus an object at the same distance as the subject and lock the focus before recomposing.
- (2) Set the lens focus mode switch to <MF> and focus manually.



If focus cannot be achieved with the AF-assist beam of a Speedlite or Speedlite Transmitter ST-E2, select the center AF point. An off-center AF point may not be able to achieve focus.

## Manual Focusing

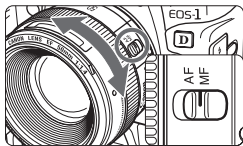

Set the lens focus mode switch to **<MF>** and turn the lens focusing ring to focus.



- If you select an AF point and press the shutter button halfway while manual focusing, the AF point will flash and the focus confirmation light will light when focus is achieved.
- During automatic AF point selection, when the center AF point achieves focus, it will flash and the focus confirmation light will light.
- With USM (Ultrasonic Motor) lenses:  
After the lens focuses in the One-Shot AF mode, you can turn the focusing ring for touch-up focusing (full-time manual focusing). (Not applicable to USM lenses with no focusing distance scale.)

## Selecting the Drive Mode

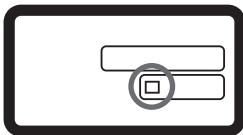
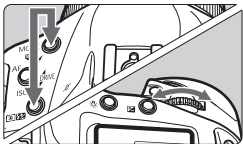

### Select the drive mode.

- Hold down the <MODE> and <[MODE] [Z]> buttons and turn the <[DRIVE] [DIAL]> dial to select the drive mode. Then let go of the buttons.
  - Single shooting
  - ☐ L Low-speed continuous shooting: Max. 3 shots per sec.
  - ☐ H High-speed continuous shooting: Max. 8.5 shots per sec.



- When you shoot, the images are first stored in the camera's internal buffer memory and then transferred to the memory card. When the buffer memory becomes full, shooting cannot continue until the buffer memory starts to empty to the memory card. As the images are transferred, you can continue shooting. Press the shutter halfway and check the viewfinder's lower right for the current maximum burst number. Note that the maximum burst number will be displayed even when there is no memory card installed. Before shooting, make sure a memory card has been installed.
- If "Card Full" is displayed in the viewfinder and on the LCD panel, wait until the access lamp turns off or stops blinking, then replace the memory card.

# Self-timer Operation

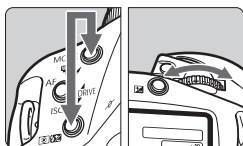

## 1 Select the self-timer mode.

- Hold down the <MODE> and <AF-ON> buttons and turn the <DRIVE> dial to select the desired self-timer mode. Then let go of the buttons.

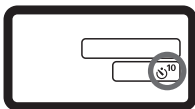

- ☺<sup>10</sup> : 10-sec. self-timer
- ☺<sup>2</sup> : 2-sec. self-timer

## 2 Focus the subject.

- Look in the viewfinder and press the shutter button halfway to check that the focus confirmation light is on and the exposure setting is displayed.

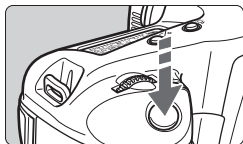

## 3 Take the picture.

- Press the shutter button completely.
  - ▶ The self-timer lamp will start blinking to indicate that it is counting down. The lamp's blinking will become faster two seconds before the picture is taken.

⚠ Do not stand in front of the camera when you press the shutter button to start the self-timer. Doing so will throw off the focus.

- Use a tripod when you use the self-timer.
- Before starting the self-timer, look through the viewfinder or cover it with the eyepiece shutter (p.111).
- To cancel the self-timer after it starts, set the <OFF> switch to <OFF>.
- When using the self-timer to shoot only yourself, use focus lock (p.81) for an object at about the same distance as where you will be.
- The 2-second self-timer is effective for close-ups or photo duplicating work to prevent camera shake (camera movement while the shutter button is pressed).

# 4

## Exposure Control

You can set the optimum metering mode, drive mode, and shooting mode (**P/Tv/Av/M**) to suit the particular subject. Other easy-to-use features are also provided for diverse shooting.



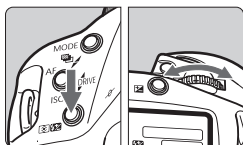

First set the <☺> switch to <ON>. If necessary, also set the <☺> switch to <ON>.

## Selecting a Metering Mode



### Select the metering mode.

- Hold down the  button and turn the  dial to select the desired metering mode. Then let go of the button.

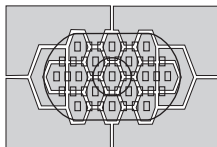
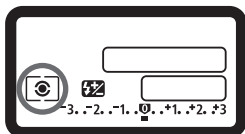

### Evaluative Metering

This is the camera's standard metering mode suited for most subjects even under backlit conditions. After detecting the subject's position in the viewfinder; the brightness, background, front and back lighting conditions; and camera orientation (horizontal or vertical), the camera sets the proper exposure.

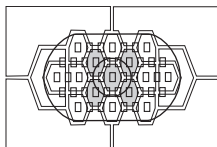

### Partial Metering

Effective when the background is much brighter than the subject due to backlighting, etc. The metering is weighted at the center covering about 13.5% of the viewfinder area.

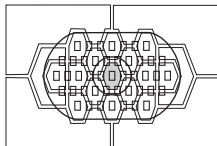

### Spot Metering

This is for metering a specific part of the subject or scene. The metering is weighted at the center covering about 3.8% of the viewfinder area.

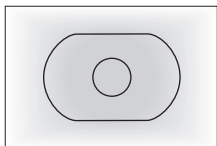

## Center-weighted Averaged Metering

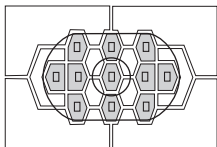

The metering is weighted at the center and then averaged for the entire scene.



## AF Point-Linked Spot Metering

To make AF point selection faster, the selectable AF points can be limited to 11 (C.Fn-13-1) or 9 (C.Fn-13-3). The AF point manually selected among the 11 or 9 will be linked to spot metering (3.8% of viewfinder). (p.83, 166)



Flash exposure compensation can be set by holding down the   > button and turning the  dial.

## Multi-Spot Metering

With multiple spot meter readings, you can see the relative exposure levels of multiple areas in the picture and set the exposure to obtain the desired result.

### 1 Set the metering mode to spot metering. (p.94)

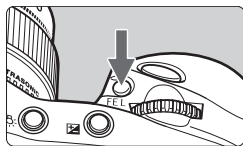

### 2 Press the <FEL> button.

- Aim the spot metering point over the area where you want a relative exposure reading, then press the <FEL> button.

▶ On the right of the viewfinder, the relative exposure level will be displayed for the spot meter reading taken.

The exposure setting displayed is the result of averaging the multiple spot meter readings.

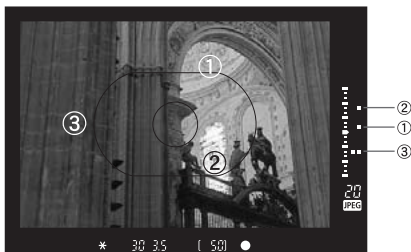

- While referring to the exposure level indicator's three spot metering marks, you can set the exposure compensation to obtain the desired result.





- You can take up to eight spot meter readings for one picture. If you press the <FEL> button to try and take a ninth spot meter reading, no spot meter reading will register.
- The exposure setting obtained with multi-spot meter readings will be canceled in the following cases:
  - (1) After taking the last spot meter reading, 16 seconds elapse.
  - (2) You press the , <MODE>, or <AF> button.
  - (3) After taking the picture, you let go of the shutter button.
- Multi-spot metering can be fixed at the center or linked to the active AF point.

# P Program AE

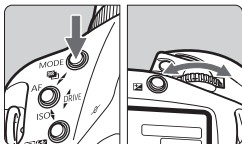

## 1 Select <P> on the LCD panel.

- Hold down the <MODE> button and turn the <mode dial> to select <P>. Then let go of the button.



## 2 Focus the subject.

- Look through the viewfinder and aim the Area AF ellipse over the subject. Then press the shutter button halfway.
- ▶ The AF point which achieves focus flashes briefly and the focus confirmation light <●> in the viewfinder lights at the same time.
- ▶ The exposure setting will be displayed on the LCD panel and in the viewfinder.

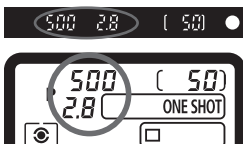

## 3 Check the display.

- ▶ The shutter speed and aperture value will be set automatically and displayed in the viewfinder and on the LCD panel.
- As long as the shutter speed and aperture value are not blinking, the exposure will be correct.

## 4 Take the picture.

- Compose the shot and press the shutter button completely.



- If “**30**” and the maximum aperture blink, it indicates underexposure. Increase the ISO speed. Or use flash.
- If “**8000**” and the minimum aperture blink, it indicates overexposure. Decrease the ISO speed. Or attach a ND (neutral density) filter (optional) to the lens.



- If automatic AF point selection (p.82) has been set, all the AF points that achieve focus will light.
- **P** stands for Program.
- AE stands for Auto Exposure.
- If the focus confirmation light <●> blinks, the shutter will lock and a picture cannot be taken.
- You can freely change the shutter speed and aperture combination (program) while retaining the same exposure. This is called program shift. To shift the program, press the shutter button halfway and turn the <☀> dial until the desired shutter speed or aperture is displayed. After you take the picture, the program shift will be canceled.

# Tv Shutter-Priority AE

In this mode, you set the shutter speed and the camera automatically sets the aperture value to suit the brightness of the subject. This is called Shutter-Priority AE. A fast shutter speed can freeze the motion of a fast-moving subject and a slow shutter speed can blur the subject to give the impression of motion.

\***Tv** stands for Time value.



Fast shutter speed



Slow shutter speed

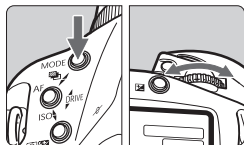

## 1 Select <Tv> on the LCD panel.

- Hold down the <MODE> button and turn the <mode dial> to select <Tv>. Then let go of the button.



## 2 Set the desired shutter speed.

- Look at the top LCD panel and turn the <shutter speed dial>.

## 3 Focus the subject.

- Press the shutter button halfway.  
▶ The aperture value is set automatically.



## 4 Check the viewfinder display and shoot.

- As long as the aperture value is not blinking, the exposure will be correct.

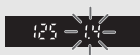

- If the maximum aperture blinks, it indicates underexposure. Turn the <img alt="dial icon" data-bbox="735 130 775 145"/> dial to set a slower shutter speed until the aperture value stops blinking. Or increase the ISO speed.



- If the minimum aperture blinks, it indicates overexposure. Turn the <img alt="dial icon" data-bbox="735 280 775 295"/> dial to set a faster shutter speed until the blinking stops. Or decrease the ISO speed.



### Shutter Speed Display

The shutter speeds from “8000” to “4” indicate the denominator of the fractional shutter speed. For example, “125” indicates 1/125 sec. Also, “0”5” indicates 0.5 sec. and “15”” is 15 sec.

# Av Aperture-Priority AE

In this mode, you set the desired aperture and the camera sets the shutter speed automatically to suit the subject brightness. This is called aperture-priority AE.

A larger aperture (smaller f/number) will result in a blurred background ideal for portraits. The lower the f/number, the more blurred the background will become. If a smaller aperture (larger f/number) is used, the foreground and background will be in focus. The higher the f/ number, the clearer the focus will be for both near and far subjects.

\* **Av** stands for Aperture value.



With a large aperture opening



With a small aperture opening

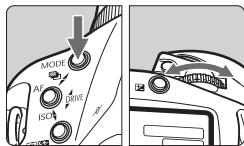

## 1 Select <Av> on the LCD panel.

- Hold down the <MODE> button and turn the <  > dial to select <Av>. Then let go of the button.



## 2 Set the desired aperture value.

- Look at the top LCD panel and turn the <  > dial.

## 3 Focus the subject.

- Press the shutter button halfway.
- ▶ The shutter speed is set automatically.

125 5.6 (50)

## 4 Check the viewfinder display and shoot.

- As long as the shutter speed is not blinking, the exposure will be correct.



- If the "3000" shutter speed blinks, it indicates underexposure. Turn the <img alt="Sun icon" data-bbox="835 248 875 268"/> dial to set a larger aperture (smaller f/number) until the shutter speed stops blinking. Or increase the ISO speed.



- If the "8000" shutter speed blinks, it indicates overexposure. Turn the <img alt="Sun icon" data-bbox="835 399 875 419"/> dial to set a smaller aperture (larger f/number) until the aperture stops blinking. Or decrease the ISO speed.



### Aperture Value Display

The larger the f/number, the smaller the aperture opening will be. The aperture values displayed will differ depending on the lens. If no lens is attached to the camera, "00" will be displayed for the aperture value.

### Depth-of-field Preview

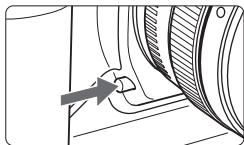

Press the depth-of-field preview button to stop down to the current aperture setting. The diaphragm in the lens will be set to the current aperture so you can check the depth of field (range of acceptable focus) through the viewfinder.



The exposure will be locked (AE lock) while you press the depth-of-field preview button.

# M Manual Exposure

In this mode, you set both the shutter speed and aperture value as desired. To determine the exposure, refer to the exposure level indicator in the viewfinder or use a handheld exposure meter. This method is called manual exposure.

\***M** stands for Manual.

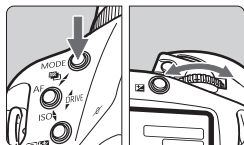

## 1 Select <M> on the LCD panel.

- Hold down the <MODE> button and turn the <MODE> dial to select <M>. Then let go of the button.

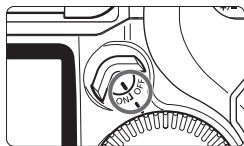

## 2 Turn the <ON/OFF> switch to <ON>.

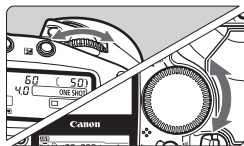

## 3 Turn the <SHUTTER SPEED> dial to set the shutter speed and turn the <APERTURE> dial to set the aperture.

- To set the aperture, you can also press the <APERTURE> button and turn the <APERTURE> dial.



## 4 Focus the subject.

- Press the shutter button halfway.
- ▶ The exposure setting will be displayed. On the right of the viewfinder, the exposure level indicator <□> indicates the current exposure level relative to the standard exposure index <◇>.



Exposure level indicator



## 5 Set the exposure.

- Check the exposure level and set the desired shutter speed and aperture value.

## 6 Take the picture.





## Setting Exposure Compensation

Exposure compensation is used to alter the standard exposure setting set by the camera. You can make the image look lighter (increased exposure) or darker (decreased exposure). The exposure compensation amount can be set up to  $\pm 3$  stops in 1/3-stop increments. **First set the  switch to <ON>.**

### 1 Press the shutter button halfway. ()





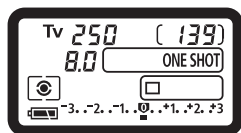

- Check the exposure level.

### 2 Turn the dial to set the desired exposure compensation amount.

- ▶ The exposure level indicator  is displayed on the LCD panel, and the exposure compensation icon  and the exposure level indicator  are displayed in the viewfinder.
- To cancel exposure compensation, set the exposure level indicator to the standard exposure index ( or ).

### 3 Take the picture.



-  ● You can also set exposure compensation by pressing the  button () and turning the  dial.
- The exposure compensation amount will remain in effect even after the  switch is set to <OFF>.
- Take care not to turn the  dial and change the exposure compensation inadvertently. To prevent this, turn the  switch to <OFF>.

## Auto Exposure Bracketing

The camera brackets the exposure automatically up to  $\pm 3$  stops in  $1/3$ -stop increments for three successive shots. This is called Auto Exposure Bracketing (AEB). AEB is possible by automatically changing the shutter speed or aperture or by changing the ISO speed and keeping the shutter speed and aperture fixed.

### AEB with the Shutter Speed or Aperture

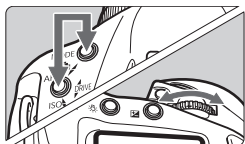

#### 1 Set the AEB amount.

- Press the <MODE> and <AF> buttons simultaneously and turn the <AEB>.
- The diagram on the left shows an AEB amount of  $\pm 1$  stop centering on the standard exposure level. The AEB amount (1.0), the AEB range <■>, and the <■> icon will be displayed.

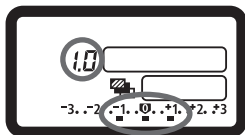

#### 2 Take the picture.

- ▶ The viewfinder's exposure level indicator will indicate the respective bracketing amount as each shot is taken.
- The current drive mode will be used for the AEB shooting.
- After the three bracketed shots are taken, AEB will not be canceled. To cancel AEB, set the AEB amount to "0.0".



Standard exposure



Decreased exposure



Increased exposure

## AEB with the ISO Speed

Set the ISO speed that is to be the standard AEB exposure. For example, if you want AEB with  $\pm 1$  stop and ISO 200, 400, and 800, set the ISO speed to 400.

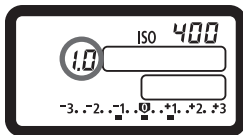
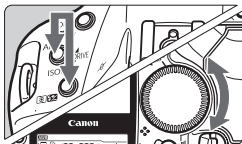

### Set the AEB amount.

- Hold down the <AF> and <[AEB]> buttons simultaneously and turn the <[AEB]> dial.
- The diagram on the left shows an AEB amount of  $\pm 1$  stop centering on the standard exposure level. The AEB amount (1.0), the AEB range <[AEB]>, and the <ISO> icon will be displayed.
- You can also set it while looking at the exposure level indicator in the viewfinder.
- The shooting operation will be the same as AEB shooting while changing the shutter speed or aperture.

- AEB cannot be used with flash or bulb exposures.
- AEB shooting is possible only within the settable shutter speed range (1/8000 - 30 sec. ), aperture range, and ISO speed range (100 - 1600). It is not possible with ISO 50 and 3200 even if the ISO speed extension is [On].
- If you use C.Fn-06-2 to set the exposure setting increment to 1/2 stop, AEB shooting with the ISO speed will not be possible.

- In the continuous shooting mode, holding down the shutter button will take all three bracketed shots continuously, then the shooting will stop automatically (except during mirror lockup).
- When AEB is used with the self-timer, the three bracketed shots will be taken in succession after the 2- or 10-second self-timer delay.
- If the drive mode is set to single shooting, press the shutter button three times to take the three AEB shots.
- AEB can be combined with exposure compensation.
- During AEB shooting, the <[AEB]> icon in the viewfinder and the <[AEB]> or <ISO> icon on the LCD panel will blink.

# \* AE Lock

AE lock enables you to lock the exposure at a different place from the point of focus. After locking the exposure, you can recompose the shot while maintaining the desired exposure setting. This is called AE lock. It is effective for backlit subjects.

## 1 Focus the subject.

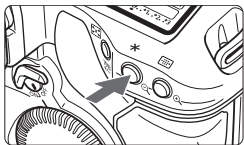

## 2 Press the <\*> button. (⓪6)

- Aim the viewfinder center over the subject where you want to lock the exposure, then press the <\*> button.
- ▶ The <\*> icon will light in the viewfinder and the exposure setting will be locked (AE lock).
- Each time you press the <\*> button, it locks the current exposure setting.



## 3 Recompose and take the picture.

- The exposure level indicator will show the AE lock exposure level and the current exposure level in real-time.
- If you want to maintain the AE lock while taking more shots, hold down the <\*> button and press the shutter button to take another shot.



 Partial or spot metering is recommended for AE lock over a specific point. (p.94)

# Bulb Exposures

When bulb is set, the shutter stays open while you hold down the shutter button fully, and closes when you let go of the shutter button. This is called bulb exposure. Use bulb exposures for night scenes, fireworks, the heavens, and other subjects requiring long exposures.

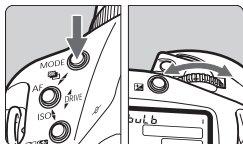

## 1 Display “buLb” on the LCD panel.

- Hold down the <MODE> button and turn the <MODE> dial to select “buLb”. Then let go of the button.

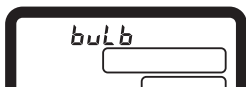

## 2 Turn the <MODE> dial to set the aperture.

## 3 Take the picture.

- Press the shutter button completely.
  - ▶ The elapsed exposure time will be displayed on the LCD panel.
- ①: sec. , ②: min. , ③: hour

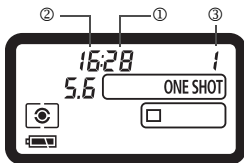

- Bulb exposures may result in grainy images due to picture noise. Under the menu's <CAM> tab, set [Noise reduction] (p.78) to reduce the noise.
- For bulb exposures, using Remote Switch RS-80N3 or Timer Remote Controller TC-80N3 (both optional) is recommended.

## LCD Panel Illumination

The <LCD> button on the upper right of the camera toggles the LCD panel illumination on and off. To end the bulb exposure, release the shutter button completely.

## Mirror Lockup

Mirror lockup is enabled with C.Fn-12. (p.165) The mirror can be swung up separately from when the exposure is made. This prevents mirror vibrations which may blur the image during close-ups or when a super telephoto lens is used. Set Custom Functions with **MENU** <  >.

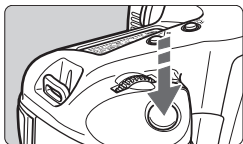

### 1 Press the shutter button completely.

- ▶ The mirror will lock in the up position.

### 2 Again press the shutter button completely.

- ▶ The picture is taken and the mirror goes back down.



- In very bright light such as at the beach or ski area on a sunny day, take the picture promptly after mirror lockup.
- During mirror lockup, do not point the camera lens at the sun. The sun's heat can scorch and damage the shutter curtains.
- Bulb exposures cannot be used with the self-timer. During the self-timer countdown, if you let go of the shutter button, there will be a shutter-release sound. This is not the shutter release (no picture is taken).



- During mirror lockup, the drive mode will be single shooting () to override the current drive mode (single or continuous).
- The mirror locks up, and after 30 seconds, it will go back down automatically. Pressing the shutter button completely again locks up the mirror again.
- For mirror lockup shots, using Remote Switch RS-80N3 or Timer Remote Controller TC-80N3 (both optional) is recommended.

## Eyepiece Shutter

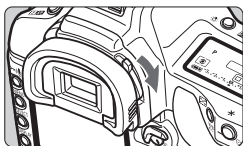

If you take a picture without looking through the viewfinder, stray light may enter the eyepiece and affect the exposure. To prevent this, turn the eyepiece shutter lever as shown by the arrow to shutter the eyepiece.

# Flash Photography

## With EX-series Speedlites

An EOS-dedicated, EX-series Speedlite makes flash photography as easy as any AE mode. For details on using the EX-series Speedlite, refer to the Speedlite's instruction manual. The EOS-1D Mark II N is a Type-A camera compatible with all EX-series Speedlites providing the features below.

---

### • E-TTL II Autoflash

E-TTL II is a new autoflash exposure system incorporating improved flash exposure control and lens focusing distance information, making it more precise than the previous E-TTL (evaluative flash metering with preflash) system. The camera can execute E-TTL II autoflash with any EX-series Speedlite.

### • High-Speed Sync (FP Flash)

High-speed sync (FP or focal-plane flash) enables flash synchronization with all shutter speeds from 30 sec. to 1/8000 sec.

### • FE (Flash Exposure) Lock

Press the camera's <FEL> button to lock the flash exposure at the desired part of the subject. This is the flash equivalent of AE lock.

### • Flash exposure compensation

In the same way as normal exposure compensation, you can set exposure compensation for flash. Set flash exposure compensation up to  $\pm 3$  stops in 1/3-stop increments.

### • FEB (Flash Exposure Bracketing)

FEB is the flash version of AEB. (Only with FEB-compatible Speedlites.) Set flash exposure bracketing up to  $\pm 3$  stops in 1/3-stop increments.

### • E-TTL II wireless autoflash with multiple Speedlites

Like with wired, multiple Speedlites, E-TTL II wireless autoflash with multiple Speedlites provides all the above features. Since connection cords are unnecessary, flexible and sophisticated lighting setups are possible. (Only with wireless-compatible Speedlites.)



## Metered Manual Flash Exposure

For closeup flash photography, you can set the flash exposure manually. With an EX-series Speedlite having a manual flash mode, follow the procedure below:

### 1 Set the camera and Speedlite settings.

- Set the camera's shooting mode to <M> or <Av>.
- Set the Speedlite to manual flash.

### 2 Focus the subject.

- Focus manually.

### 3 Aim the center spot metering circle over the subject, then press the <FEL> button (ⓘ16).

- ▶ The Speedlite will fire a preflash and the required flash output is retained in memory.
- ▶ In the viewfinder, the exposure level indicator will indicate the currently-set flash exposure level relative to the standard exposure index.

### 4 Set the flash exposure level.

- Adjust the Speedlite's manual flash level and the camera aperture so that the flash exposure level indicator is aligned with the standard exposure index.

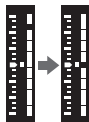

### 5 Take the picture.

## TTL and A-TTL Autoflash Speedlites

- With TTL and A-TTL autoflash Speedlites (EZ-, E-, EG-, ML-, TL-series) set in the TTL or A-TTL autoflash mode, the flash will be fired only at full output. If you set the camera's shooting mode to manual or aperture-priority AE, you can adjust the aperture and fire the flash at full output. Meanwhile, the Speedlite will remain in the TTL or A-TTL autoflash mode.
- When the 580EX or 550EX is set to C.Fn-03-1, the flash will always be fired at full output even in the TTL autoflash mode.

## Non-Canon Flash Units

### Sync Speed

The EOS-1D Mark II N can synchronize with compact, non-Canon flash units at 1/250 sec. or slower shutter speeds. With large studio flash, the sync speed is 1/125 sec. or slower. Be sure to test the flash to see if it synchronizes properly with the camera.

### PC Terminal

- The camera's PC terminal is provided for flash units having a sync cord. The PC terminal is threaded to prevent inadvertent disconnection.
- The camera's PC terminal has no polarity so you can connect any sync cord regardless of its polarity.



- If the camera is used with a flash unit (with dedicated flash contacts) or flash accessory dedicated to another camera brand, the camera may not operate properly and camera malfunction may result. Also, do not connect to the camera's PC terminal any flash unit requiring 250 V or higher voltage.
- Do not attach a high voltage flash unit on the camera's hot shoe. It might not work.



A Speedlite attached to the camera's hot shoe and a flash unit connected to the PC terminal can be used at the same time.

# 5

## Image Playback

---

You can view or erase the images you captured with the camera. You can even add a sound recording to an image.

**For images taken with another camera:**

The camera might not be able to properly display images captured with a different camera or edited with a personal computer or whose file names were changed.

## MENU Reviewing Images

You can see the image on the LCD monitor immediately after you take the picture. You can set one of three image review options: **[On]** to display the image, **[On (INFO.)]** to display both the image and shooting information, and **[Off]** to not display the image.

### 1 Select [Review].

- Select the <📷> tab.
- Hold down the <SELECT> button and turn the <🌀> dial to select **[Review]**. Then let go of the button.

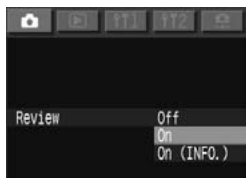

### 2 Select the desired setting.

- Hold down the <SELECT> button and turn the <🌀> dial to select the desired setting. Then let go of the button.

### 3 Take the picture.

- ▶ The captured image will be displayed on the LCD monitor.

Review **[On]** setting



Review **[On (INFO.)]** setting



While the image is displayed, it can also be magnified (p.124).

## Image Review Time

You can change the number of seconds the image is displayed on the LCD monitor after being captured.

### 1 Select [Review time].

- Select the <CAM> tab.
- Hold down the <SELECT> button and turn the <DISP> dial to select [Review time]. Then let go of the button.

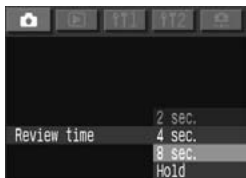

### 2 Select the desired setting.

- Hold down the <SELECT> button and turn the <DISP> dial to select the desired setting. Then let go of the button.

 The [Hold] setting will set the review time to half of the auto power off (p.45) time. If auto power off is [Off], the image review time will be 15 min.

## MENU Auto Image Rotation

Vertical shots can be rotated automatically so that they are displayed upright during playback.

**Auto rotate will work only with vertical images captured while [Auto rotate] was [On]. Auto rotate will not work with vertical images captured while [Auto rotate] was [Off].**

### 1 Select [Auto rotate].

- Select the <T1> tab.
- Hold down the <SELECT> button and turn the <DIAL> dial to select [Auto rotate]. Then let go of the <SELECT> button.

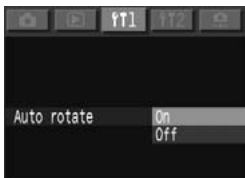

### 2 Select the desired setting.

- Hold down the <SELECT> button and turn the <DIAL> dial to select [On]. Then let go of the button.

### 3 Take a vertical shot.

- For the image review right after image capture, the image will not be displayed vertically on the LCD monitor.



### 4 Playback the image.

- Press the <DISPLAY> button.
- ▶ The vertical shot will be displayed vertically as shown on the left.

 If the vertical image is taken while the camera is pointed up or down, the image might not rotate automatically for playback.

 When you change the camera's orientation between horizontal and vertical, the camera orientation sensor will make a small sound. This is not a defect.

## MENU Setting the LCD Brightness

You can adjust the brightness of the LCD monitor to one of five levels.



### 1 Select [LCD Brightness].

- Select the <YT2> tab.
  - Hold down the <SELECT> button and turn the <DIAL> dial to select [LCD Brightness]. Then let go of the button.
- ▶ The brightness adjustment screen will appear.



### 2 Adjust the brightness.

- While referring to the gray chart on the screen's left, hold down the <SELECT> button and turn the <DIAL> dial to adjust the brightness. Then let go of the button.



To check the image's exposure, look at the histogram (p.123).

# Image Playback

You can select any captured image to view. You can view a single image, the shooting information, an index display, or a magnified view.

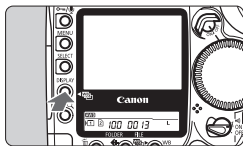

## 1 Playback the image.

- Press the <DISPLAY> button.
- ▶ The last captured image will appear on the LCD monitor.

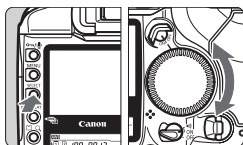

## 2 Select the image.

- Hold down the <SELECT> and turn the <DISP.> dial. To playback images starting with the last image, turn the dial counterclockwise. To playback images starting with the first image, turn the dial clockwise.



- If you quit the image playback and return to image playback without doing any shooting, the image playback will start with the image last displayed. (Except when <DISP.> switch is <OFF> or auto power off.)
- If you leave the camera in playback mode, the playback mode will turn off after half of the auto power-off time elapses (p.45). If the auto power-off function is [Off], the playback mode will turn off automatically after 15 minutes.
- You can playback only the images in the current folder. To view images in a different folder, select that folder first (p.72).



## Changing the Image Display Format

### 1 Playback the image.

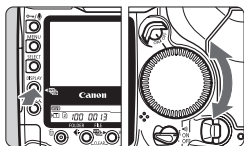

### 2 Change the image display format.

- Hold down the <DISPLAY> button and turn the <DISP> dial.
- ▶ The image display format on the LCD monitor will change.
- When the desired image display format appears, let go of the button.



### Image display format

Shooting information



Single image



Four-image index



Nine-image index



## Shooting Information Display

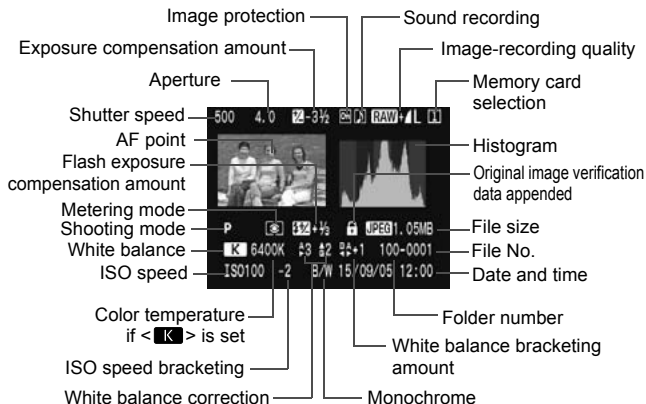

### **MENU** Highlight Alert

Set the <▶> menu's [**Highlight alert**] to [**On**]. This will display the highlight alert on the shooting information and single image displays. Any overexposed areas will blink. (p.40)

To obtain more image detail in the overexposed areas, set the exposure compensation to a negative amount and shoot again.

### **MENU** AF Point Display

When the <▶> menu's [**Display AF points**] is [**On**], the AF point(s) used to achieve focus will be shown on the shooting information display. (p.40)

If the image was taken in the One-Shot AF mode, the AF point which achieved focus will be displayed. If automatic AF point selection was used, you may see multiple AF points which achieved focus.

If AI Servo AF was used, the selected AF point will be displayed.

## **MENU** Histogram Display

With the <▶> menu, you can set [**Histogram display**] to [**Bright.**] or [**RGB**]. (p.40)

### **[Bright.] Display**

This histogram is a graph showing the distribution of the image's brightness level. The horizontal axis indicates the brightness level (darker on the left and brighter on the right), while the vertical axis indicates how many pixels exist for each brightness level.

The more pixels there are toward the left, the darker the image. And the more pixels there are toward the right, the brighter the image.

If there are too many pixels on the left, the shadow detail will be lost. And if there are too many pixels on the right, the highlight detail will be lost. The tones in-between will be reproduced.

By checking the image's brightness histogram, you can see the exposure level bias and the overall tone reproduction condition.

#### Sample Histograms



Dark image



Normal image



Bright image

### **[RGB] Display**

This histogram is a graph showing the distribution of the image's brightness level of each primary color (RGB or red, blue, and green). The horizontal axis indicates the color's brightness level (darker on the left and brighter on the right), while the vertical axis indicates how many pixels exist for each color brightness level. The more pixels there are toward the left, the darker and less prominent the color. And the more pixels there are toward the right, the brighter and denser the color. If there are too many pixels on the left, the respective color information will be lacking. And if there are too many pixels on the right, the color will be too saturated with no detail.

By checking the image's RGB histogram, you can see the color's saturation and gradation condition and white balance bias.

## Magnified View

You can magnify the image by 1.5x to 10x on the LCD monitor.

### 1 Select the image to be magnified.

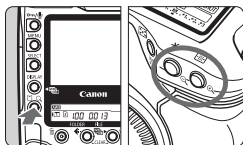

### 2 Magnify the image.

- Hold down the <Q> button and press the <Q> button to magnify the image or press the <Q> button to reduce the image.
- The lower right of the screen shows the position of the magnified section.

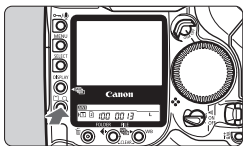

### 3 Scroll around the image.

- Hold down the <Q> button and turn the <Z> dial to scroll horizontally or turn the <Q> dial to scroll vertically.
- To exit the magnified display, press the <DISPLAY> button.

In step 2, you can start the magnified view at the center of the image or at a AF point.



### Set [Enlarge display set.].

- Under the <▶> tab, set [Enlarge display set.].

#### [Enlarge from image center]

Starts the magnified view at the center.

#### [Enlarge from selected AF point]

Starts the magnified view at the selected AF point. This is convenient for checking the focus.

- While in the magnified view, you can maintain the same magnified view and position when you hold down the <SELECT> button and turn the <Q> dial to view another image.
- In the case of images shot with automatic AF point selection or with manual focus, the magnification will start at the image center.



- With [**Enlarge from selected AF point**]
  - The starting magnification varies depending on the image size that was set.
  - If C.Fn-17-1/2 is also set, the AF point activation area will expand. The actual point of focus might therefore fall outside the starting magnification area.

## **MENU** Rotating an Image

You can rotate an image by 90° or 270° clockwise. Images will then be displayed in the correct orientation during playback.

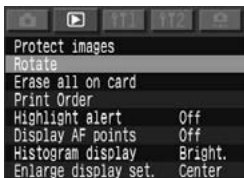

### 1 **Select [Rotate].**

- Select the <▶> tab.
- Hold down the <SELECT> button and turn the <◉> dial to select [**Rotate**]. Then let go of the button.
- ▶ The Rotate screen will appear.

### 2 **Select the image you want to rotate.**



### 3 **Rotate the image.**

- ▶ Each time you press and let go of the <SELECT> button, the image will rotate clockwise.
- To stop rotating the image, press the <MENU> button. The menu will reappear.



If you hold down the <Q> button and press the <Q> button, the 9-image index will appear.

# Viewing the Images on TV

Set the <fT2> menu's [Video system] to [NTSC] or [PAL] to match your TV system. Always turn off the camera and the television before connecting or disconnecting them.

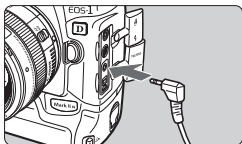

## 1 Connect the camera to the TV.

- Open the camera's terminal cover.
- Use the video cable (provided) to connect the camera's <VIDEO OUT> terminal to the TV monitor's VIDEO IN terminal.
- Insert the cable plug all the way in.

## 2 Turn on the TV and switch the TV's line input to Video IN.

## 3 Turn the camera's <ON> switch to <ON>.

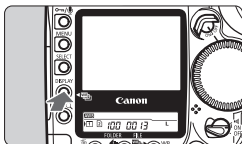

## 4 Press the <DISPLAY> button.

- ▶ The image will appear on the TV screen. (Nothing will be displayed on the camera's LCD monitor.)
- After you finish, set the <ON> switch to <OFF>, turn the TV off, then disconnect the video cable.

- If the proper video system format is not set, the image will not be displayed properly. If necessary, select the <fT2> tab and set [Video system] to the proper video system.
- Do not use any video cable other than the one provided. Images might not be displayed if you use a different video cable.
- Depending on your TV or monitor, part of the image might be truncated.

# Image Protection



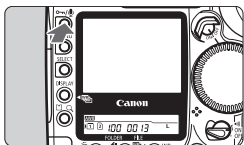

## Protecting a Single Image

This prevents the image from being erased accidentally.



### 1 Display the image to be protected.



### 2 Protect the image.

- Press the  button.
- ▶ The  icon will then appear to indicate that the image is protected.
- To cancel the image protection, press the  button again. The  icon will disappear.
- You can also protect the image right after capture by pressing the  button during the image review.



- Since the  button has dual functions for image protection and sound recording (p.129), if you press the button too long (2 sec.), sound recording will start instead and image protection will not be set. To apply image protection, press the  button and let it go immediately.
- Note that formatting the memory card will also erase any protected images.

- The image can be protected regardless of the display format.
- Protected images cannot be erased with the camera's Erase function. To erase protected images, first cancel the image protection.
- If you use "Erase all" (p.131, 132) when there are protected images, all images except the protected ones will be erased. This is convenient when you want to erase unnecessary images all at once.

**MENU Protecting All Images in a Folder or Card**

You can protect all the images in the selected folder (p.72) or memory card all at once. Or you can cancel the image protection all at once.

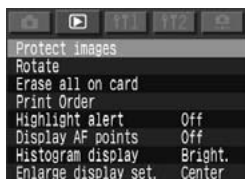
**1 Select [Protect images].**

- Select the <▶> tab.
- Hold down the <SELECT> button and turn the <⦿> dial to select **[Protect images]**. Then let go of the button.

**2 Select the desired protection setting.**

- Hold down the <SELECT> button and turn the <⦿> dial to select the desired setting. Then let go of the button.
- ▶ A confirmation dialog will appear.
- Hold down the <SELECT> button and turn the <⦿> dial to select **[OK]**. Then let go of the button.



 Protected images cannot be erased with the camera's Erase function. To erase protected images, first cancel the image protection.



# Sound Recording for an Image

You can record and add sound to any image. The sound data is recorded in the image and can be played with the software provided.

## 1 Display the image to have sound.

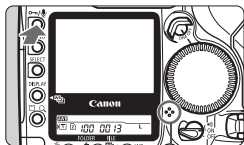

microphone



## 2 Record the sound.

- Press the  $\langle \text{M}/\text{MIC} \rangle$  button for about 2 sec.
- When **[Recording]** appears, keep pressing the  $\langle \text{M}/\text{MIC} \rangle$  button and speak into the built-in microphone. The maximum time for a single sound recording is 30 sec.
- To end the sound recording, let go of the button.
- ▶ Images having a sound recording will have the  $\langle \text{M} \rangle$  icon displayed.



- Sound recording is possible while in any image display format.
- Sound recording is not possible with a protected image.
- The camera cannot playback the sound.
- To make a sound recording longer than 30 sec. , repeat step 2 to make another recording for the same image.
- You can also record sound right after image capture during the image review by following step 2.

# Erasing Images

You can erase a single image with the  $\langle \text{trash} \rangle$  button, erase all images in a folder, or use menu commands to erase all images in a memory card. Only protected images will not be erased.

**ⓘ** Once an image is erased, it cannot be recovered. Make sure you no longer need the image before erasing it. To prevent important images from being erased accidentally, protect it.

## Erasing a Single Image

**1** Display the image to be erased.

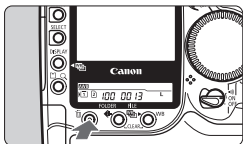

**2** Press the  $\langle \text{trash} \rangle$  button.

- The Erase menu will appear at the bottom of the screen. To exit the erase menu, press the  $\langle \text{trash} \rangle$  button again.

**3** Erase the image.

- Hold down the  $\langle \text{trash} \rangle$  button and turn the  $\langle \text{dial} \rangle$  dial to select [OK]. Then let go of the button.
- ▶ The access lamp will light or blink and the image will be erased.



 You can also follow steps 2 and 3 to erase the image right after capture during the image preview.

## Erasing All Images in a Folder

- 1 **Select the folder containing the images to be erased.** (p.72)
- 2 **Set the playback mode.**
  - Press the <DISPLAY> button.
  - If the folder selection screen is displayed, hold down the <DISPLAY> button and turn the <DISP.> dial to set the playback mode. Any image display format is okay.

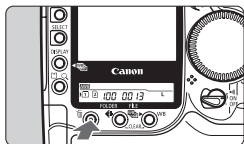

- 3 **Press the <Erase> button.**
  - The Erase menu will appear at the bottom of the screen.



- 4 **On the Erase menu, select [ALL].**
  - ▶ Hold down the <Erase> button and turn the <DISP.> dial to select [ALL]. Then let go of the button.
  - ▶ The confirmation dialog will appear.



- 5 **Erase the images.**
  - Hold down the <Erase> button and turn the <DISP.> dial to select [OK]. Then let go of the button.
  - ▶ The access lamp will light or blink and all the unprotected images in the folder will be erased.

**MENU Erasing All Images in the Memory Card****1 Select [Erase all on card].**

- Select the <▶> tab.
- Hold down the <SELECT> button and turn the <⦿> dial to select [**Erase all on card**]. Then let go of the button.
- ▶ The confirmation dialog will appear.

**2 Erase the images.**

- Hold down the <SELECT> button and turn the <⦿> dial to select [**OK**]. Then let go of the button.
- ▶ All unprotected images on the memory card will be erased.
- After the images are erased, the menu will reappear.

**!** Once an image is erased, it cannot be recovered. Make sure you no longer need the image before erasing it.

## MENU Formatting a Memory Card

- ⓘ Formatting a memory card will erase all the data in the card, including protected images. Before formatting a card, make sure there is nothing you need to keep. If necessary, transfer the images to a personal computer before formatting the card.

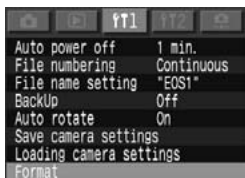

### 1 Select [Format].

- Select the <T1> tab.
- Hold down the <SELECT> button and turn the <DIAL> dial to select [Format]. Then let go of the button.



### 2 Select the card to be formatted.

- [Card1] is the CF card, and [Card2] is the SD card.
- Hold down the <SELECT> button and turn the <DIAL> dial to select the card. Then let go of the button.
- ▶ A confirmation dialog will appear.



### 3 Select [OK].

- If [Card2] for the SD card is selected, low-level formatting is possible (p.134).
- Hold down the <SELECT> button and turn the <DIAL> dial to select [OK]. Then let go of the button.
- ▶ The memory card will be formatted. When it is completed, the menu will reappear.



A non-Canon memory card or a card formatted with another camera or personal computer might not work properly with the camera. If this happens, format the card with the camera first. Then it might work with the camera.

 The memory card's capacity displayed on the Format screen may be lower than the capacity indicated on the card.

### Handling “Card Err”

If “**Card Err**” is displayed on the LCD panel, it indicates a problem with the memory card that is preventing the image data from being recorded or read. Use another memory card instead.



Or, if you have a memory card reader (commercially available), use it to transfer all the images from the card to a personal computer. After checking that all the images are in the personal computer, format the card with the camera. It may then return to normal.

## About Low-level Formatting

Low-level formatting is possible only when [**Card2**] for the SD card is selected. If the writing speed to the SD card is slower than usual or if you want to completely erase the data in the SD card, checkmark [**Low Level Format**] and format the card. Since the entire card will be wiped out, the formatting will take slightly longer than normal formatting.



### Press the < > button.

- In step 3 on page 133, press the <  > button.
- ▶ Checkmark the [**Low Level Format**] option.
- To cancel the checkmark, press the <  > button again.
- With the [**Low Level Format**] option checkmarked, select [**OK**] to start the low-level formatting.

- 
- Low-level formatting is not possible with [**Card1**] selected for the CF card.
  - You can stop the low-level formatting by selecting [**Cancel**]. Even in this case, normal formatting will have been completed and you can use the SD card as usual.

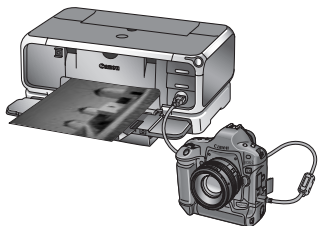

# 6

## Direct Printing from the Camera

For the latest information on connecting the camera to a Canon printer, see the Canon Web site at [canon.com/pictbridge](http://canon.com/pictbridge).

You can connect the camera directly to a printer and print out the images in the memory card. The camera enables direct printing with printers compatible with “<img alt="PictBridge icon" data-bbox="145 525 175 555"/> PictBridge”, Canon “<img alt="CP Direct icon" data-bbox="145 525 175 555"/> CP Direct”, and Canon “<img alt="Bubble Jet Direct icon" data-bbox="145 525 175 555"/> Bubble Jet Direct.”

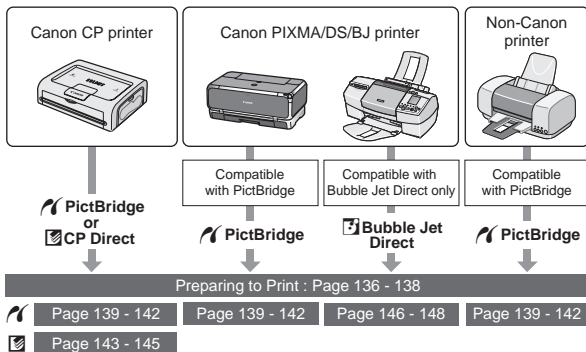

# Preparing to Print

You do the direct printing procedure entirely through your camera's LCD monitor.

The operation method is the same as selecting and setting menu settings. For details, see "Menu Operations" (p.38).

**1** Set the  switch to <OFF>.

**2** Set up the printer.



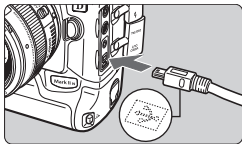



- For details, refer to the printer's manual.



**3** Connect the camera to the printer.

- Refer to the table (Printers and Cables) below to select the proper cable to connect the camera to printer.
- To connect to the printer, refer to the printer's instruction manual.

## Printers and Cables

Printer Compatibility		Suitable Cable
	PictBridge only	Interface cable provided with camera The plug at both ends have the <↔> icon.
 	PictBridge and CP Direct	
 	PictBridge and Bubble Jet Direct	
	CP Direct only	Cable provided with printer Only one plug has the <↔> icon.
	Bubble Jet Direct only	



## 4 Turn on the printer.

## 5 Set the <img alt="Power switch icon" data-bbox="575 165 615 185"/> switch to <ON>.

- ▶ Some printers may have a beeping sound.

## 6 Playback the image.

- ▶ The image and the printer icon <img alt="PictBridge icon" data-bbox="885 280 915 300"/>, <img alt="CP Direct icon" data-bbox="885 305 915 325"/>, or <img alt="Bubble Jet Direct icon" data-bbox="885 330 915 350"/> indicating a printer connection will be displayed.
- The procedure will be different depending on the icon displayed. See the applicable pages below.

### PictBridge





### CP Direct



### Bubble Jet Direct



Icon	Direct Print Type	Reference pages
	PictBridge	139 - 142
	CP Direct	143 - 145
	Bubble Jet Direct	146 - 148

- RAW images are not compatible with direct printing.
- If you use a battery to power the camera, make sure it is fully charged. During direct printing, keep checking the battery level.
- If there is a long beeping sound in step 5, it indicates a problem with the PictBridge printer. To find out what's wrong, do the following:  
Press the <▶> button to playback the image and follow the steps below.
  1. Press the <SELECT> button.
  2. On the print setting screen, select **[Print]**.  
The error message will be displayed on the LCD monitor. See "**Error Messages**" on page 142.
- Before disconnecting the cable, turn off the camera and printer. Pull out the cable while holding the plug, not the cord.
- When connecting the camera to the printer, do not use any cable other than the dedicated interface cable.
- Do not disconnect the cable during direct printing.

 For direct printing, using the DC Coupler Kit DCK-E1 (p.27) is recommended to power the camera.

### To Windows XP and Mac OS X (10.1 or later) Users

When you connect the camera to a personal computer with the USB cable provided with the camera, you can upload the JPEG images in the camera's memory card to the personal computer via PTP (Picture Transfer Protocol). For details, see the EOS DIGITAL Software Instruction Manual (PDF).

# Printing with PictBridge

The setting options will differ depending on the printer. Some settings might be disabled. For details, refer to your printer's instruction manual.

Printer connected icon



## 1 Select the image to be printed.

- Check that the <PictBridge icon> is displayed on the upper left of the LCD monitor.

## 2 Press the <SELECT> button.

- ▶ The print setting screen will appear.

### Print setting screen

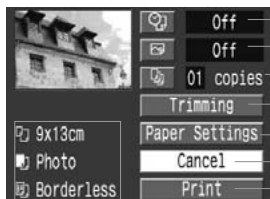

Set the date or file number imprinting to on or off.

Set the printing effects.

Sets the quantity to be printed.

Sets the trimming area.

Sets the paper size, type, and layout.

Returns to the screen in step 1.

Starts the printing.

The paper size, type, and layout you have set will be displayed.

\* Depending on the type of printer, the date and file number imprinting, trimming, and other settings might not be available.

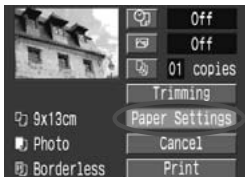

## 3 Select [Paper Settings].

- ▶ The Paper Settings screen will appear.

## Setting the Paper Size



- Select the size of the paper to be loaded in the printer.
- ▶ The Paper Type screen will appear.

## Setting the Paper Type



- Select the type of paper to be loaded in the printer.
- ▶ The Page Layout screen will appear.

### About the Paper Type

If you are using a Canon PIXMA/DS/BJ printer with Canon paper, set the respective paper type as follows:

<b>Photo</b>	Photo Paper Plus Glossy
<b>Fast Photo</b>	Photo Paper Pro
<b>Default</b>	Photo Paper Plus Glossy



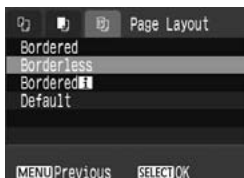

If you are using a non-Canon printer, refer to the printer's instruction manual.

## Setting the Page Layout



- Select the desired layout.
- ▶ The print settings screen will reappear.

## About Page Layout

Borderless	The print will have no white borders. If your printer cannot print borderless prints, the print will have borders.
Bordered	The print will have a white border along the edges.
Bordered 	The shooting data will be imprinted on the border on 9x13cm and larger prints.
xx-up	Option to print 2, 4, 8, 9, 16, or 20 copies of same image on one sheet.
20-up  35-up 	On A4 / Letter size paper, 20 or 35 thumbnails of the images ordered through DPOF will be printed. [20-up 
Default	With a Canon printer, the print will be borderless.

\* From the Exif data, the camera name, lens name, shooting mode, shutter speed, aperture, exposure compensation amount, ISO speed, white balance, etc., will be imprinted.

\*\* This depends on the <img alt="Date/File number imprinting icon" data-bbox="365 448 385 468"/> date/file number imprinting option set in step 4.

## 4 Set the other options.

- If necessary, you can also set the <img alt="Date/File number imprinting icon" data-bbox="495 528 515 548"/> date/file number imprinting, <img alt="Printing effects icon" data-bbox="495 553 515 573"/> printing effects, and <img alt="Number of copies icon" data-bbox="495 578 515 598"/> number of copies.

 Date/File number imprinting

 Printing effects

 Number of copies



- Depending on the BJ printer, the <img alt="Printing effects icon" data-bbox="495 785 515 805"/> Printing effects setting may enable you to select the **[Vivid]** (for vivid greens and blue sky), **[NR]** (noise reduction), **[Vivid+NR]**, **[Face]** (compensate for a dark face caused by backlighting) or **[On]** setting.
- For details on trimming, see page 149.



## 5 Start printing.

- Select [**Print**].
- ▶ The printing will start.
- When the printing ends, the screen will return to step 1.
- To stop the printing, select [**OK**] while [**Stop**] is displayed.



- Depending on the image's file size and recording quality, it may take some time for the printing to start after you select [**Print**].
- The [**Default**] setting for printing effects and other options are the printer's own default settings as set by the printer's manufacturer. See the printer's instruction manual to find out what the default settings are.

### Handling Printer Errors

If you resolve a printer error (no ink, no paper, etc.) and select [**Continue**] to resume printing but it does not resume, operate the printer to resume printing. For details, see the printer's instruction manual.

### Error Messages

If a problem occurs during printing, an error message will appear on the camera's LCD monitor. Press the <SELECT> button to stop printing. After resolving the problem, resume printing. For details on how to resolve a printing problem, refer to the printer's instruction manual.

#### Paper Error

Check whether the paper is properly loaded in the printer.

#### Ink Error

The printer has run out of ink or the waste ink tank is full.

#### Hardware Error

Check for any printer problems other than paper and ink problems.

#### File Error

The selected image cannot be printed. Images captured with a different camera or images edited with a personal computer might not be printable. Also, if the image's file size or pixel count is too large, printing might not be possible with certain printers.

## Printing with CP Direct

Printer connected icon



### 1 Select the image to be printed.

- Check that the <SELECT> icon is displayed on the upper left of the LCD monitor.

### 2 Press the <SELECT> button.

- ▶ The print setting screen will appear.

### Print setting screen

Trimming frame: Appears when you want to trim the image.



Sets the quantity to be printed.

Sets the trimming area.

Sets the printing style.

Returns to step 1.

Starts the printing.

The printing style settings are displayed.

<☺> is the date icon.

### 3 Select [Style].

- ▶ The Style screen will appear.

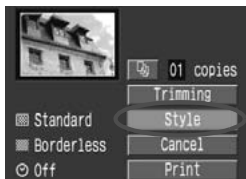

## 4 Set the options as desired.

- Set the [Image], [Borders], and [Date] as desired.

[Image]



[Borders]



[Date]

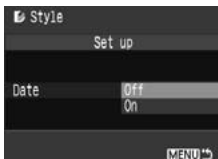

- [Image] is selectable when card-size paper is used. If you select [Multiple], 8 small images of the same picture will be printed on the paper.
- Check the [Borders] and [Date] settings and set them if necessary.
- When you are done, press the <MENU> to return to the print setting screen.

## 5 Set the number of copies.

- Set as necessary.
- Set a number from 1 to 99.



## 6 Set the trimming.

- Set as necessary.
- For details on trimming, see page 149.





## 7 Start printing.

- Select **[Print]**.
- ▶ The printing will start.
- When the printing ends, the screen will return to step 1.
- To stop the printing, select **[OK]** while **[Stop]** is displayed.



- The date may look light if it is imprinted on a bright background or border.
- If **[Multiple]** is selected, **[Borders]** and **[Date]** cannot be selected. **[Borderless]** will be set and **[Date]** will be set to **[Off]**. The image will also be cut off along all four edges.



- If **[Date]** is **[On]**, the date recorded for the image will appear on the print. The date will appear on the lower right of the image.
- If you select **[Stop]** while printing only one picture, the printing will not stop until it finishes printing the picture. If you are printing multiple pictures, the printing will stop after the current picture is finished printing.
- If a problem occurs during printing, an error message will appear on the camera's LCD monitor. Select **[Stop]** or **[Resume]** (after resolving the problem). If **[Resume]** is not displayed, select **[Stop]**.

# Printing with Bubble Jet Direct

Printer connected icon



## 1 Select the image to be printed.

- Check that the <SELECT> icon is displayed on the upper left of the LCD monitor.

## 2 Press the <SELECT> button.

- ▶ The print setting screen will appear.

### Print setting screen

Trimming frame: Appears when you want to trim the image.



01 copies — Sets the quantity to be printed.

Trimming — Sets the trimming area.

Style — Sets the printing style.

Cancel — Returns to step 1.

Print — Starts the printing.

The printing style settings are displayed.

<☺> is the date icon.

## 3 Select [Style].

- ▶ The Style screen will appear.

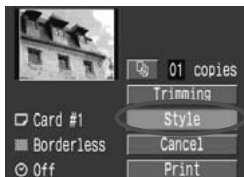

## 4 Set the options as desired.



- **[Paper]** is the size of the paper loaded in the printer.
- Check the **[Borders]** and **[Date]** settings and set them if necessary.
- When you are done, press the <MENU> to return to the print setting screen.



## 5 Set the number of copies.

- Set as necessary.
- Set a number from 1 to 99.

## 6 Set the trimming.

- Set as necessary.
- For details on trimming, see page 149.



## 7 Start printing.

- Select **[Print]**.
- ▶ The printing will start.
- When the printing ends, the screen will return to step 1.
- To stop the printing, select **[OK]** while **[Stop]** is displayed.

**!** If **[Bordered]** is set, the date might be imprinted on the border, depending on the printer.

- !**
- If **[Date]** is **[On]**, the date recorded for the image will appear on the print. The date will appear on the lower right of the image.
  - If you select **[Stop]** during the printing, the picture being printed will stop printing and the paper will be discharged.
  - If a problem occurs during printing, an error message will appear on the camera's LCD monitor. Select **[Stop]** or **[Continue]**. If you select **[Continue]** and the printer does not resume printing, it will resume automatically after you resolve the problem.
  - If you are using a BJ printer equipped with an operation display panel, the error No. will be displayed if an error occurs. To resolve the respective error, refer to the BJ printer's instruction manual.

# Setting the Trimming

You can trim the image and print only the trimmed portion as if the image was recomposed.

**Do the trimming right before printing.** If you set the trimming and then set the print settings, you may have to set the trimming again.



## 1 Select [Trimming].

- ▶ The trimming screen will appear.



## 2 Trim the image.

- The image area within the trimming frame will be printed.
- The operation guide disappears while you trim the image. It will reappear after 5 sec. of idle time.



### Changing the trimming frame size and moving the frame

- You can change the trimming frame size in the same way you magnify or reduce the image display. For details, see "Magnified View" (p.124).



### Rotating the frame

- Each time you press the <C-1/2> button, the trimming frame will toggle between the vertical and horizontal orientations.

Image area to be printed

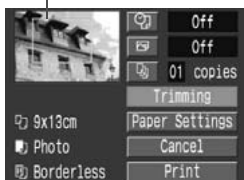

### 3 Exit the menu.

- Press the <SELECT> button.
- ▶ The Print setting screen will reappear.
- ▶ On the upper left, you can see the trimmed image area that will be printed.

- Depending on the printer, the trimmed image area might not be printed as you specified.
- The smaller you make the trimming frame, the grainier the picture will look. If the picture will be too grainy, the trimming frame will turn red.
- When trimming the image, look at the camera's LCD monitor. If you look at the image on a TV screen, the trimming frame might not be displayed accurately.

 The trimming frame shape will be different depending on the **[Paper settings]**, **[Image]** / **[Paper]**, **[Page layout]** / **[Borders]** settings.

# 7

## DPOF: Digital Print Order Format

With DPOF (Digital Print Order Format), you can specify which images in the memory card are to be printed and the quantity. This feature is very convenient when you make prints with a DPOF-compatible printer or photo lab.

### **About DPOF**

DPOF (Digital Print Order Format) is a standard for recording print ordering instructions to the memory card. It is for images taken with a digital camera, and you can specify which photos and the quantity to print. With a DPOF-compatible digital camera, you can do the following:

- By inserting a memory card into a DPOF-compatible printer, you can make prints as specified.
- Printers capable of direct printing from the camera can print the images as specified by DPOF.
- When ordering prints from a photo lab, you do not need to fill in any order form to specify the image selections, quantity, etc.

# Print Order

## Print Settings

Set the print type, date imprinting, and file No. imprinting. The print settings will be applied to all print-ordered images. (They cannot be set individually for each image.) The print settings are set in the same way as with menu settings.

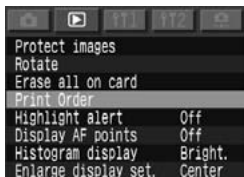

### 1 Select [Print Order].

- ▶ The Print Order screen will appear.

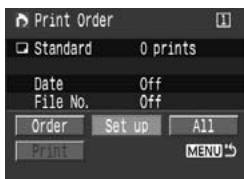

### 2 Select [Set up].

- ▶ The Set up screen will appear.

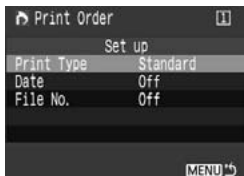

### 3 Set the options as desired.

- Set the [Print Type], [Date], and [File No.].

#### [Print Type]





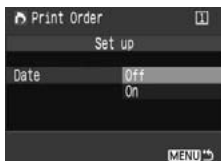

#### [Date]

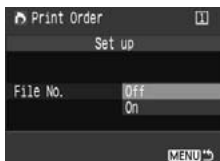

#### [File No.]





Print Type		Standard	Prints one image on one paper.
		Index	Multiple, thumbnail images are printed on one paper.
	 	Both	Prints both the standard and index prints.
Date	On	[On] imprints the recorded date on the print.	
	Off		
File No.	On	[On] imprints the file No. on the print.	
	Off		

## 4 Exit the menu.

- Press the <MENU> button.
- ▶ The Print Order screen will reappear.
- Next, select [**Order**] or [**All**] to select the images to be printed.



- RAW images cannot be selected for printing.
- Even if [**Date**] and [**File No.**] are set to [**On**], the date or file No. might not be imprinted depending on the print type setting and printer type.
- With [**Index**] prints, both the [**Date**] and [**File No.**] cannot be set to [**On**] at the same time.
- When printing with DPOF, you must use the memory card whose Print Order specifications have been set. It will not work if you just extract images from the memory card and try to print them.
- Certain DPOF-compatible printers and photo labs might not be able to print the photos as you specified. If this happens with your printer, refer to the printer's instruction manual. Or check with your photo lab about compatibility when ordering prints.
- Do not insert into the camera a memory card containing images captured by a different camera and then try to order prints. The images specified for the print order might be inadvertently overwritten. Also, depending on the image type, the print order may not be possible.

## Selecting Individual Images

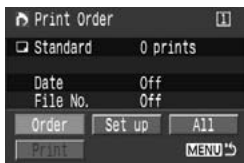

### 1 Select [Order].

- ▶ The order screen will appear.



### 2 Select the image to be printed.

- With the same procedure for magnifying and reducing the image (p.124), reducing it will result in a three-image display. Magnifying it will bring it back to normal size.

Three-image view



### 3 Set the print settings.

- The print order will vary depending on the [Print Type] (p.152) setting.

You can set the quantity for each image for standard-type prints.

If you want to include the image in the index print, checkmark <✓> the box. Otherwise, leave the box unchecked.

- If there are other images you want to select, repeat steps 2 and 3.
- You can select up to 998 images.

Indication when [Standard] and [Both] are set.



Indication when [Index] is set.



## 4 Exit the menu.

- Press the <MENU> button.
- ▶ The Print Order screen will reappear.
- Press the <MENU> button again to save the print order to the memory card. The menu will then reappear.

### Selecting All Images

The print order can also be set or canceled for all the images in the memory card. With standard printing, one print will be printed for each image.

Note that after following the “Selecting Individual Images” procedure, if you do the “Selecting All Images” procedure, the print order will change to “All images.”

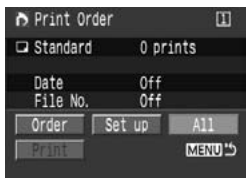

## 1 Select [All].

- ▶ The All screen will appear.

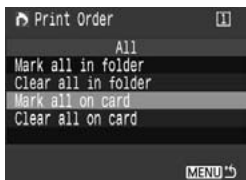

## 2 Select the desired setting.

- Select [**Mark all in card**] or [**Mark all in folder**].
- If you select [**Clear all in card**], all the images in the memory card selected for printing will be deselected.
- If you select [**Clear all in folder**], all the images in the folder selected for printing will be deselected.

### 3 Exit the menu.

- On the Print Order screen, press the <MENU> button.
- ▶ The settings will be saved to the memory card, and the menu will reappear.

- Note that RAW images cannot be selected for printing even when you set "Mark all."
- When using a PictBridge printer, print no more than 400 images for one print order. If you specify more than this, all the selected images might not be printed.

# Direct Printing with DPOF

With a printer compatible with direct printing, you can easily print images specified with DPOF.

## 1 Prepare to print.

- See pages 136-137 and follow “Preparing to Print” up to step 5.

## 2 Select [Print Order].

- ▶ The Print Order screen will appear.



## 3 Select [Print].

- [Print] will be displayed only if the camera is connected to the printer and printing is possible.
- ▶ The print setting screen will appear.



## 4 Set the printing options.

PictBridge

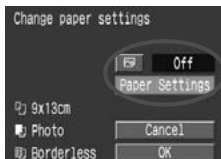

CP Direct



Bubble Jet Direct



PictBridge

- Set the [Paper settings] and <img alt="Print icon"/> printing effects. (p.139)

## CP Direct / Bubble Jet Direct

- Set the **[Style]**. (p.143/146)

## 5 Start printing.

- Select **[OK]**.
- ▶ The printing will start.
- To stop the printing, select **[OK]** while **[Stop]** is displayed.

- When printing with a PictBridge or Bubble Jet Direct printer, be sure to set the paper size.
- With PictBridge, the file No. cannot be printed with certain printers.
- If **[Bordered]** is set, the date might be imprinted on the border, depending on the printer.
- The date might look light if it is imprinted on a bright background or border.

- With CP Direct, if **[Print type]** is set to **[Index]**, the number of images printed on one index sheet will be as follows:
  - Credit card size: 20 images
  - 9 x 13 cm size: 42 images
  - 10 x 14.8 cm size: 63 images
 As for the number of index images with Bubble Jet Direct, see the BJ printer's instruction manual.
 

If you stopped the printing and want to continue printing the remaining images, select **[Resume]**. Note that printing will not resume if you stop the printing and any of the following occurs:

  - Before resuming the printing, you changed the print order settings.
  - Before resuming the printing, you erased an image that was to be printed.
  - In the case of index printing with CP Direct, you changed the paper cassette before resuming the printing.
  - In the case of index printing with PictBridge, you changed the paper settings before resuming the printing.
  - When you stopped the printing, the memory card's remaining capacity was low.
- If there is a printing problem, see page 142 for PictBridge, page 145 for CP Direct, or page 148 for Bubble Jet Direct.

# 8

## Customizing the Camera

---

Custom Functions enable you to customize various camera features to suit your picture-taking preferences.

## MENU Setting a Custom Function

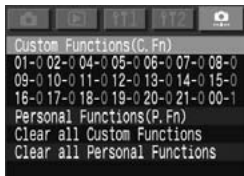

### 1 Select [Custom Functions (C.Fn)].

- Select the <MENU> tab.
- Hold down the <SELECT> button and turn the <DISP> dial to select [**Custom Functions (C.Fn)**]. Then let go of the button.



### 2 Set the Custom Function.

- Hold down the <SELECT> button and turn the <DISP> dial to select the Custom Function to be set. Then let go of the button.
- Hold down the <SELECT> button and turn the <DISP> dial to select the desired setting. Then let go of the button.

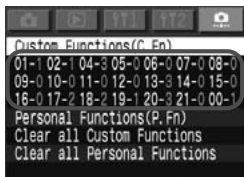

### 3 Exit the menu.

- Press the <MENU> button.
- ▶ The Custom/Personal Function menu will reappear.
- ▶ The respective Custom Function setting (number) will be displayed in the Custom Function list.

## Clearing All Custom Functions

In step 1 above, if you select [**Clear all Custom Functions**], the Clear all Custom Functions screen will appear.

- Hold down the <SELECT> button and turn the <DISP> dial to select [**OK**]. When you let go of the button, all the Custom Function settings will be cleared.



## **MENU** Custom Function Settings

C.Fn-03 is unused.

### **C.Fn-01 Finder display during exposure**

**0: No viewfinder display**

**1: Finder display on**

Displays the exposure information and number of remaining shots during continuous shooting.

### **C.Fn-02 Shutter release without card**

**0: Possible without card**

**1: Not possible**

The shutter button will not work without a memory card in the camera. This prevents shooting without a memory card.

If there is no memory card and you press the shutter button, "Card" will blink on the top LCD panel and in the viewfinder. It indicates that C.Fn-02-1 is in effect.

### **C.Fn-04 Shutter button/AE lock button**

**0: AF/AE lock**

**1: AE lock/AF**

You can focus at one location and obtain AE lock at another location in the scene. Press the <★> button to autofocus and press the shutter button halfway to attain AE lock.

**2: AF/AF lock, no AE lock**

In the AI Servo AF mode, you can press the <★> button to stop the AF operation momentarily. This prevents the AF from being thrown off by any obstacle passing between the camera and subject. The exposure is set at the moment the picture is taken.

**3: AE/AF, no AE lock**

This is useful for subjects which keep moving and stopping repeatedly. In the AI Servo AF mode, you can press the <★> button to start or stop the AI Servo AF operation. The exposure is set at the moment the picture is taken. Thus, the focusing and exposure will always be at the optimum point as you wait for the decisive moment.



C.Fn-04 and C.Fn-19-0/1/2 (p.168) both have AF start/stop and AE lock functions. If you have set both these Custom Functions and you execute both Custom Function operations, the latter operation will not work. The only exception will be when AF stop is executed after AF start.

## C.Fn-05 Manual Tv/Av set. for M exp.

0: Tv= Av=

1: Tv= Av=

This is convenient when you often have to change the aperture during studio shooting with studio flash units. Also, when you use AEB in the manual exposure mode, the shutter speed can stay fixed while only the aperture is shifted for AEB.

To set the shutter speed, hold down the button (or the button if C.Fn-11-1/2 is set) and turn the dial.

2: Tv= Av= w/o lens

You set the shutter speed and aperture in the same way as with C.Fn-05-0. And you can still set the aperture even while the lens is detached from the camera. Convenient especially if you want to use a super telephoto lens with more than one EOS-1D Mark II N camera body.

3: Tv= Av= w/o lens

You set the shutter speed and aperture in the same way as with C.Fn-05-1. And you can still set the aperture even while the lens is detached from the camera.

## C.Fn-06 Exposure level increments

0: 1/3-stop set 1/3-stop comp.

1: 1-stop set 1/3-stop comp.

Sets full-stop increments for the shutter speed and aperture.

2: 1/2-stop set 1/2-stop comp.

Sets 1/2-stop increments for the shutter speed, aperture, and exposure compensation.

- The exposure compensation will be displayed in the viewfinder and on the LCD panel as shown below.

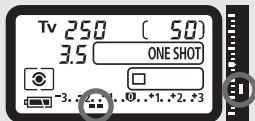

- When C.Fn-06-2 is set, AEB with the ISO speed will be disabled.

**C.Fn-07 USM lens electronic MF****0: Turns on after One-Shot AF****1: Turns off after One-Shot AF**

This prevents the focus from being thrown off by inadvertent turning of the focusing ring after One-Shot AF. With both C.Fn-07-1 and C.Fn-07-2, manual focusing is possible with the lens focus mode switch set to <MF>.

**2: Disabled in AF mode**

Electronic manual focusing is disabled in the AF mode.

**Applicable lenses**

EF50mm f/1.0L USM, EF85mm f/1.2L USM, EF200mm f/1.8L USM, EF300mm f/2.8L USM, EF400mm f/2.8L USM, EF400mm f/2.8L II USM, EF500mm f/4.5L USM, EF600mm f/4L USM, EF1200mm f/5.6L USM, EF28-80mm f/2.8-4L USM.



When both C.Fn-04 and C.Fn-07 are set, electronic manual focusing will be enabled or disabled as follows:

Custom Function No.		C.Fn-04	
	Setting	0, 2	1, 3
C.Fn-07	0	O/O	O/O
	1	X/X	X/X
	2	X/X	X/X

\* When in focus/Not in focus O: Enabled X: Disabled

**C.Fn-08 Top LCD panel / Back LCD panel****0: Remain. shots/File No.****1: ISO/Remain. shots**

Displays the ISO speed at all times. The number of remaining shots on the rear LCD panel is displayed with more digits.

**2: ISO/File No.**

Displays the ISO speed instead of the number of remaining shots. You can tell when the number of remaining shots is low by seeing a low maximum burst count displayed on the right in the viewfinder.

**3: Shots in [ ] /Remain. shots**

Displays the number of images saved in the selected folder. The number of remaining shots on the top LCD panel is displayed with more digits. Images recorded in the RAW+JPEG mode are counted as 1 per shot.



The ISO speed display in the viewfinder also changes in the same way.

**C.Fn-09 Auto bracketing sequence/cancel**

You can change the AEB sequence when the pictures are bracketed with the shutter speed or aperture and the file-saving sequence for white balance bracketing (WB-BKT).

When "Auto cancellation" is set, bracketing will be canceled after you change the lens or turn the <☺> switch to <OFF>.

**0: 0, -, +/Auto cancellation**

**1: 0, -, +/No cancellation**

The first bracketed shot is the standard exposure (or exposed with the standard white balance). This bracketing sequence can be repeated.

**2: -, 0, +/Auto cancellation**

Starts the bracketing sequence with the minus (or bluish or magenta bias) setting.

**3 -, 0, +/No cancellation**

Repeats the bracketing sequence starting with the minus (or bluish or magenta bias) setting. This bracketing sequence can be repeated.

AEB	WB bracketing	
	B/A Bias	M/G Bias
0 : Standard exposure	0 : Standard white balance	0 : Standard white balance
- : Decreased exposure	- : More blue	- : More magenta
+ : Increased exposure	+ : More amber	+ : More green

**C.Fn-10 AF point illumination**

**0: On**

**1: Off**

The AF point does not light at all. Effective when it is bothersome to see it light up.

**2: On without dimming**

The selected AF point will not be dimmed.

**3: Brighter**

Effective when the AF point lighting is difficult to see with C.Fn-10-0.

## C.Fn-11 AF point selection method

0: = +    = +

1: = +    = +

This reverses the functions of the > button and > button.

2: = **only**    = +

- While exposure metering is active, turn the > dial to select a horizontal AF point. (If C.Fn-13-3 has been set, select a peripheral AF point.) This is also possible while you press the shutter button halfway and during continuous shooting with AI Servo AF. The AF point selection stops at the extreme left, extreme right, top-most, and bottom-most AF points.

- During autofocus, you can press the > button to switch instantly to the automatic AF point selection mode.

- You can also select the AF point (including automatic AF point selection) with the same operation as C.Fn-11-1.

- If both C.Fn-11-2 and C.Fn-18-1/2 (p.168) have been set, select a vertical AF point by pressing the > button and turning the > dial.

3: = FEL +    = FEL +

This reverses the functions of the > button and <FEL> button.

## C.Fn-12 Mirror lockup

0: **Disable**

1: **Enable**

Effective for close-up and telephoto shots to prevent camera shake caused by the mirror's reflex action. See page 111 for the mirror lockup procedure.

**C.Fn-13 Number of AF points/Spot metering****0: 45/Center AF point****1: 11/Active AF point**

The selectable AF points are limited to 11. Spot metering is linked to the active AF point. (p.95)

**2: 11/Center AF point**

The selectable AF points are limited to 11. Spot metering is linked to the center AF point. (p.95)

**3: 9/Active AF point**

The selectable AF points are limited to 9. Spot metering is linked to the active AF point. (p.95)

**4: 9/Center AF point**

The selectable AF points are limited to 9. Spot metering is at the center. (p.95)

-  ● The metering mode must be set to spot metering before it can be linked to the AF point.
- If C.Fn-13-1/2 is set or cleared, the registered AF point (p.84) will be replaced by the center AF point.

-  ● Any metering mode besides spot metering can be used.
- With C.Fn-13-1/2/3/4, all 45 AF points will be available for automatic selection.
- With C.Fn-13-1/3, FE lock is possible with any AF point you select.

**C.Fn-14 E-TTL II****0: Evaluative**

Fully automatic flash photography for all conditions, from low light to daylight fill-flash.

**1: Average**

The flash exposure will be averaged over the Area AF ellipse. Since automatic flash exposure compensation will not be executed, you may have to set it yourself depending on the scene. This also applies if you use FE lock.

## C.Fn-15 Shutter curtain synchronization

### 0: 1st-curtain synchronization

### 1: 2nd-curtain synchronization

By using a slow sync speed, you can create a light trail following a moving subject. The flash fires right before the shutter closes. This Custom Function can be used to obtain 2nd-curtain sync effects even with EX-series Speedlites which do not have this feature. If an EX-series Speedlite having this feature is set for 2nd-curtain sync, it will override this Custom Function.

## C.Fn-16 Safety shift in Av or Tv

Safety shift can be set for the shutter-priority AE and aperture-priority AE modes.

### 0: Disable

### 1: Enable

If the subject's brightness changes suddenly and the current shutter-priority AE or aperture-priority AE setting becomes unsuitable, the shutter speed or aperture is shifted to obtain a suitable exposure automatically.

## C.Fn-17 AF point activation area

### 0: Single AF point

### 1: Expand (TTL. of 7 AF points)

The AF point activation area expands by one point all around the manually-selected AF point. A total of 7 AF points become active. This setting is effective for when only one manually-selected AF point is unable to focus track a subject moving erratically.

### 2: Automatic expand (max. 13)

The camera automatically sets the AF point activation area to 7 or 13 points to suit the lens focal length and AF mode. This is effective when the subject's movement is unpredictable.



- The AF point activation area centers on the selected AF point. Therefore, if a peripheral AF point is selected, the AF point activation area will be smaller as shown below.



- Setting C.Fn-13 will also expand the AF point activation area.

## C.Fn-18 Switch to registered AF point



0:  + 

1: 

Press the < > button to switch to the registered AF point.

2: **Only while pressing** 

Switch to the registered AF point only while you press the < > button. When you release the button, the AF point selected previously becomes active again. You can thereby easily switch between the selected AF point and registered AF point.

 If C.Fn-04-1/3 is also set, you can press the < > button to switch to the registered AF point and start the AF at the same time.

## C.Fn-19 Lens AF stop button function

0: **AF stop**

1: **AF start**

AF operates only while the AF stop button is pressed. While the button is pressed, AF operation with the camera is disabled.

2: **AE lock while metering**

When the button is pressed while metering is still active, AE lock takes effect. Convenient when you want to focus and meter separately.

3: **AF point: M → Auto/Auto → Ctr.**

In the manual AF point selection mode, the button instantly switches to automatic AF point selection (among 45 AF points) from manual AF point selection only while you hold it down. Convenient when you are no longer able to focus track a moving subject with a manually-selected AF point in the AI Servo AF mode. In the automatic AF point selection mode, the button selects the center AF point only while you hold it down.

4: **AF mode: ONE SHOT ↔ AI SERVO**

In the One-Shot AF mode, the camera switches to AI Servo AF mode only while you hold down the button. In the AI Servo AF mode, the camera switches to One-Shot AF mode only while you hold down the button. Convenient when you need to keep switching between One-Shot AF and AI Servo AF for a subject which keeps moving and stopping.

5: **IS start**

With the lens' IS switch already ON, the Image Stabilizer operates only while you press the button.

 The AF stop button is provided only on IS super telephoto lenses.



**C.Fn-20 AI SERVO tracking sensitivity****0: Standard****1: Slow / 2: Moderately slow**

Prevents the autofocus from being thrown off by any obstacle passing between the camera and subject.

**3: Moderately fast / 4: Fast**

Effective when you want to consecutively photograph multiple subjects located at random distances.



This Custom Function does not affect the AI Servo AF tracking speed.

**C.Fn-21 Drive speed priority AI SERVO****0: Disable****1: Enable**

Shooting is possible even while focus has not been achieved. Even though the focus is not quite sharp, at least you will have a picture.

**C.Fn-00 Focusing Screen****0:  Ec-N,R**

For New Laser-matte screens.

**1:  Ec-A,B,C,CII, CIII, D, H, I, L**

For Laser-matte screens.

**2:  Ec-S**

For Super precision matte screens.

EOS-1D Mark II N's standard focusing screen is the Ec-CIII, C.Fn-00-1 is already set upon factory shipment.



For C.Fn-00 when you change the focusing screen, see page 180.

## MENU Custom Function group registration

You can register up to three groups of Custom Function settings. A group of Custom Function settings can be used for a specific shooting situation such as sports, snapshotting, and landscapes. **Note that C.Fn-00 “Focusing screen” cannot be registered in any Custom Function group.**

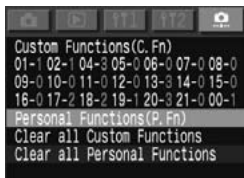

### 1 Select [Personal Functions (P.Fn)].

- Select the  tab.
- Hold down the <SELECT> button and turn the <DIAL> dial to select [Personal Functions (P.Fn)]. Then let go of the button.

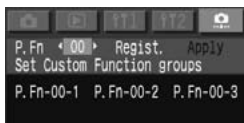

### 2 Select [P.Fn 00].

- Hold down the <SELECT> button and turn the <DIAL> dial to select [P.Fn 00]. Then let go of the button.

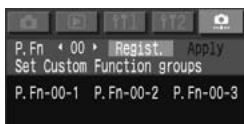

### 3 Select [Regist.] or [Apply].

- Hold down the <SELECT> button and turn the <DIAL> dial to select [Regist.] or [Apply]. Then let go of the button.
- If the P.Fn 00 group has not been registered, [Apply] cannot be selected.

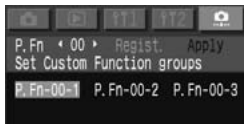

### 4 Select the group number.

- Hold down the <SELECT> button and turn the <DIAL> dial to select a group number from [P.Fn-00-1] to [P.Fn-00-3]. Then let go of the button.





### 5 Register or apply.

- Hold down the <SELECT> button and turn the <DIAL> dial to select [OK]. Then let go of the <SELECT> button.
- To register, press the <SELECT> button when the confirmation dialog appears.

# Personal Functions

Beyond Custom Functions, Personal Functions enable you to further customize your camera settings. **They are set with the provided software (Camera Window).** Only P.Fn-00 (Custom Function group registration) can be set with the camera.

P.Fn No.	Description
00	Custom Function group registration.
01	Disables the shooting modes.
02	Disables the metering modes.
03	Specifies the metering mode for manual exposure.
04	Sets the maximum and minimum shutter speeds to be used.
05	Sets the maximum and minimum apertures to be used.
06	Registers and switches the shooting mode and metering mode.
07	Repeats bracketing during continuous shooting.
08	Sets the number of shots to be bracketed.
09	Changes the bracketing sequence for C.Fn-09-2/3 to increased exposure, standard exposure, and decreased exposure.
10	Retains the shift amount for program shift.
14	Disables focus detection (search driving) by the lens drive.
15	Disables the AF-assist beam.
16	Enables automatic shooting when focus is achieved at the fixed point of focus while the shutter button is pressed fully.
17	Disables automatic AF point selection.
18	Enables automatic AF point selection when C.Fn-11-2 has been set.
19	Sets the continuous shooting speed.
20	Limits the number of shots during continuous shooting.
21	Enables quiet operation when the shutter button is OFF after shooting.
23	Changes the operation timer's time length.
24	Keeps the LCD panel illuminated during bulb exposures.
25	Sets the default settings when the CLEAR (⏏+WB) button is ON.
26	Speeds up the shutter-release time lag.
27	Enables the electronic dial's function to be used in the reverse direction.
28	Prevents exposure compensation from being set with the Quick Control Dial.
30	The <  > switch also enables the <  >.
31	Adds original image verification data.

## \* About P.Fn-11, 12, 13, 22, and 29

To preserve the same Personal Function numbers (P.Fn-00 to 31) used by previous EOS-1 series cameras, a few Personal Function numbers have been left unused.

 When a Personal Function is set, the <#> symbol will be displayed on the top LCD panel.

## MENU Clearing and Resetting Personal Functions

You can clear or reset Personal Functions that have been set and registered with the provided software. The Personal Function settings can be modified only with the provided software.

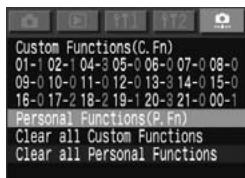

### 1 Select [Personal Functions (P.Fn)].

- Select the <P.Fn> tab.
- Hold down the <SELECT> button and turn the <DIAL> dial to select [**Personal Functions (P.Fn)**]. Then let go of the button.



### 2 Select the number of the Personal Function whose setting you want to clear or reset.

- Hold down the <SELECT> button and turn the <DIAL> dial to select Personal Function number. Then let go of the button.



### 3 Clear or reset the setting.

- Hold down the <SELECT> and turn the <DIAL> dial. To cancel the setting, select [**OFF**]. To reset, select [**ON**]. Then let go of the <SELECT> button.
  - ▶ To indicate the effective choice, [**ON**] or [**OFF**] will be displayed in green.

## Clearing All Personal Functions

In step 1 above, if you select [**Clear all Personal Functions**], the Clear all Personal Functions screen will appear.

- Hold down the <SELECT> button and turn the <DIAL> dial to select [**OK**]. When you let go of the button, all the Personal Function settings will be cleared.
- To reset the Personal Function settings, follow the procedure above.

## MENU Saving and Reading Camera Settings ■

You can save the shooting mode, menu settings, Custom Function settings, Personal Function settings, etc. , onto the memory card and later read them into the camera. Therefore, you can read all these settings into another EOS-1D Mark II N camera body.

### Saving Camera Settings

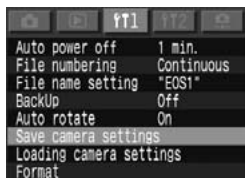

#### 1 Select [Save camera settings].

- Select the <f1> tab.
- Hold down the <SELECT> button and turn the <◁> dial to select [**Save camera settings**]. Then let go of the button.



#### 2 Save the camera settings.

- Hold down the <SELECT> button and turn the <◁> dial to select [**OK**]. Then let go of the <SELECT> button.
- ▶ The camera settings will be saved onto the memory card.



- The date/time, number of remaining shots, and other unnecessary settings will not be saved/read.
- Only one set of camera settings can be saved onto a memory card. If the memory card already has camera settings saved, they will be overwritten.

## Reading Camera Settings

**1** Transfer the camera settings saved in the memory card to the camera.

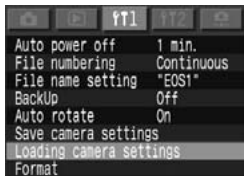

**2** Select [Loading camera settings].

- Select the <T1> tab.
- Hold down the <SELECT> button and turn the <DIAL> dial to select [Loading camera settings]. Then let go of the button.



**3** Read the camera settings.

- Hold down the <SELECT> button and turn the <DIAL> dial to select [OK]. Then let go of the <SELECT> button.
  - ▶ The menu will disappear and the camera will turn off for an instant.
  - ▶ The camera settings will be read by the camera and take immediate effect.

# 9

## Reference

---

This section will help you understand your camera better. It covers information on camera features, system accessories, and other reference information.

# Troubleshooting Guide

If there is a problem, first refer to this Troubleshooting Guide.

## Power Source

### The battery cannot be recharged.

- **You are using the wrong battery.**
  - ▶ Use the dedicated Ni-MH Pack. (p.22)
- **The battery is not properly attached to the charger.**
  - ▶ Attach the battery properly to the charger. (p.22)

### The camera does not operate even when the switch is set to <ON>.

- **The battery is exhausted.**
  - ▶ Recharge the battery. (p.22)
- **The battery is not installed properly.**
  - ▶ Install the battery properly. (p.25)
- **The memory card slot is open.**
  - ▶ Push in the memory card and close the memory card slot. (p.30)

### The access lamp lights or blinks even when the switch is set to <OFF>.

- **If you set the  switch to <OFF> right after shooting, the access lamp will still light or blink for a few seconds while the image is recorded onto the memory card.**
  - ▶ When the camera finishes recording the image to the memory card, the access lamp will stop blinking and the power will turn off.

### The battery becomes exhausted quickly.

- **The battery is not fully charged.**
  - ▶ Recharge the battery fully. (p.22)
- **The battery's service life has expired.**
  - ▶ Replace it with a new battery. (p.182)



**The camera turns off by itself.**

- **Auto power off is in effect.**
  - ▶ Set the <☺> switch to <ON> again or set auto power off to [Off]. (p.45)

**Only the <☐> icon blinks on the top LCD panel.**

- **The battery is almost exhausted.**
  - ▶ Recharge the battery. (p.22)

**Shooting****No images can be shot or recorded.**

- **The memory card is not properly installed.**
  - ▶ Install the memory card properly. (p.30)
- **The memory card is full.**
  - ▶ Use a new memory card or erase unnecessary images. (p.30, 130)
- **The battery is exhausted.**
  - ▶ Recharge the battery. (p.22)
- **You did not focus well. (The focus confirmation light in the viewfinder blinks. )**
  - ▶ Press the shutter button halfway again and focus the subject. If you still cannot focus properly, focus manually. (p.90)

**The LCD monitor does not display a clear image.**

- **The LCD monitor is dirty.**
  - ▶ Use a soft, lens cloth to clean the screen.
- **The LCD's service life has expired.**
  - ▶ Consult your nearest customer service center or dealer.

### The image is out of focus.

- **The lens focus mode switch is set to <MF>.**
  - ▶ On the lens, set the focus mode switch to <AF>. (p.29)
- **Camera shake occurred when you pressed the shutter button.**
  - ▶ To prevent camera shake, hold the camera still and press the shutter button gently. (p.34, 43)

### The memory card is unusable.

- **The data in the memory card is damaged.**
  - ▶ Format the memory card. (p.133)
  - ▶ Use the proper memory card. (p.3)

## Image Review & Operation

### The image cannot be erased.

- **The image is erase-protected.**
  - ▶ Cancel the protection. (p.127)

### The shooting date and time is wrong.

- **The correct date and time has not been set.**
  - ▶ Set the correct date and time. (p.46)

## Error Codes

If a camera error occurs, <Err xx> will be displayed on the top LCD panel. Follow the instruction below to resolve the respective error code. If the same error occurs often, something is probably wrong with the camera. Jot down the “xx” error code and take your camera to the nearest Canon Service Center.

If an error occurs after you take a picture, the camera might have missed the shot. Press the <DISPLAY> button to see if the image appears on the LCD monitor.

Error Code	Countermeasures
<b>Err 01</b>	Communications between the camera and lens is faulty. Clean the lens contacts. (p.11)
<b>Err 02</b>	There is a problem with the memory card. Try any of the following: Remove and re-install the memory card. Format the memory card. Use a different memory card.
<b>Err 03</b>	Too many folders in the memory card. Replace with a formatted memory card.
<b>Err 04</b>	The memory card is full. Erase unnecessary images in the card or replace the memory card.
<b>Err 99</b>	An error other than the above has occurred. Remove and reload the battery. This error may occur if you use a non-Canon lens and the camera or lens does not operate properly.

# Changing the Focusing Screen

You can change the camera's focusing screen to better suit the subject or shooting situation. You must also set C.Fn-00 so that the standard setting for obtaining a correct exposure matches the focusing screen.

Focusing Screen Type	Designation	C.Fn-00 Setting
:New Laser-matte	Ec-N, Ec-R	0
:Laser-matte	Ec-series (A, B, C, CII, CIII, D, H, I, L)	1
:Super precision matte	Ec-S	2

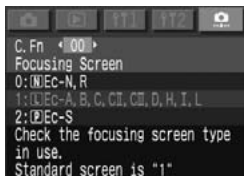

## 1 Select C.Fn-00.

- Hold down the <SELECT> button and turn the <DIAL> dial to select [00]. Then let go of the button.
- Hold down the <SELECT> button and turn the <DIAL> dial to select the desired setting. Then let go of the button.



## 2 Check the message.

- Hold down the <SELECT> button and turn the <DIAL> dial to select [OK]. Then let go of the button.

C.Fn-00 cannot be registered in any Custom Function group.

- If you do not change the focusing screen that came with the camera, you need not change C.Fn-00-1 factory setting.
- To change the focusing screen, refer to the instructions that came with the focusing screen.
- The Ec-A, Ec-B, Ec-I, and Ec-L focusing screens have a prism at the center. A correct exposure reading cannot be obtained with evaluative metering or spot metering based on the center area where there is a prism. Use center-weighted averaged metering or off-center spot metering with such focusing screens.

## Ec-series Interchangeable Focusing Screens

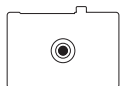
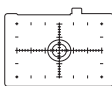
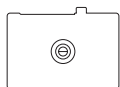
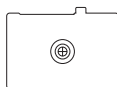
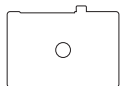
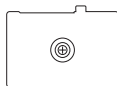
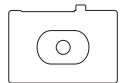
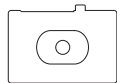
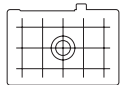
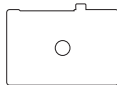
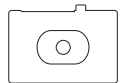
**Ec-A: Standard microprism****Ec-H: Laser-matte with scale****Ec-B: New split screen****Ec-I: Laser-matte with cross hair****Ec-CII: All Laser-matte****Ec-L: Cross split screen****Ec-CIII: Laser-matte****Ec-N: New Laser-matte****Ec-D: Laser-matte with grid****Ec-R: New Laser-matte****Ec-S: Super precision matte**

## Major Accessories (Optional)



### Ni-MH Pack NP-E3

Dedicated, high-capacity power pack. Rated voltage of 12 V. It can be recharged up to 500 times. When fully charged, it enables the camera to take up to about 1200 shots at normal temperature.



### Ni-MH Charger NC-E2

Quick charger dedicated to the Ni-MH Pack NP-E3. Excess charging prevented. It takes about 120 minutes to recharge one pack. Two packs can be attached to it at one time. The discharge function takes about 8.5 hours to cancel the pack's memory effect. It runs on 100 - 240 V AC.



### Shoe-mount Speedlites

Flash photography with an EX-series Speedlite is as easy as normal auto exposure shooting without flash. All EX-series Speedlites enable E-TTL II autoflash, high-speed sync (FP flash), and FE lock. With the 580EX, an easy-to-use, wireless E-TTL II autoflash system is possible with multiple Speedlites.



### Macro Lites

The EX-series Macro Lites are ideal for close-up flash photography.



You can fire only one or both flash tubes and control the flash ratio to easily obtain sophisticated lighting effects with E-TTL II autoflash. Also, high-speed sync (FP flash), FE lock, and a multi-Speedlite, wireless system (with the 580EX or 430EX as a slave) are possible to achieve various macro flash effects.



### Remote Switch RS-80N3

This is a remote switch with an 80 cm cord to prevent camera shake for super-telephoto shots, macroshooting, and bulb exposures. The switch has the same effect as pressing the shutter button halfway or completely. A shutter-release lock is also provided. The quick-lock plug connects to the camera's remote control terminal.



### Timer Remote Controller TC-80N3

Attached with an 80 cm cord, this remote switch has four built-in functions: 1. Self-timer, 2. Interval timer, 3. Bulb-exposure timer, and 4. Shutter-release count setting. The timer can be set anywhere from 1 sec. to 99 hours, 59 min. , 59 sec. in 1-sec. increments. The connection plug for the camera has a quick-lock feature.



### Wireless Controller LC-5

Wireless controller effective up to 100 meters. It consists of a transmitter and receiver. The receiver's camera connection plug connects to the camera's remote control terminal.



### E-series Dioptic Adjustment Lenses

One of ten E-series dioptic adjustment lenses ( $-4$  to  $+3$  diopters) can be attached to the camera's eyepiece to further expand the dioptic adjustment range.



### Memory card

Data storage media where the captured images are recorded. Using Canon memory cards is recommended.



### PC card adapter

Enables a CF card to be inserted into a PC card slot or PC card reader.

# System Map

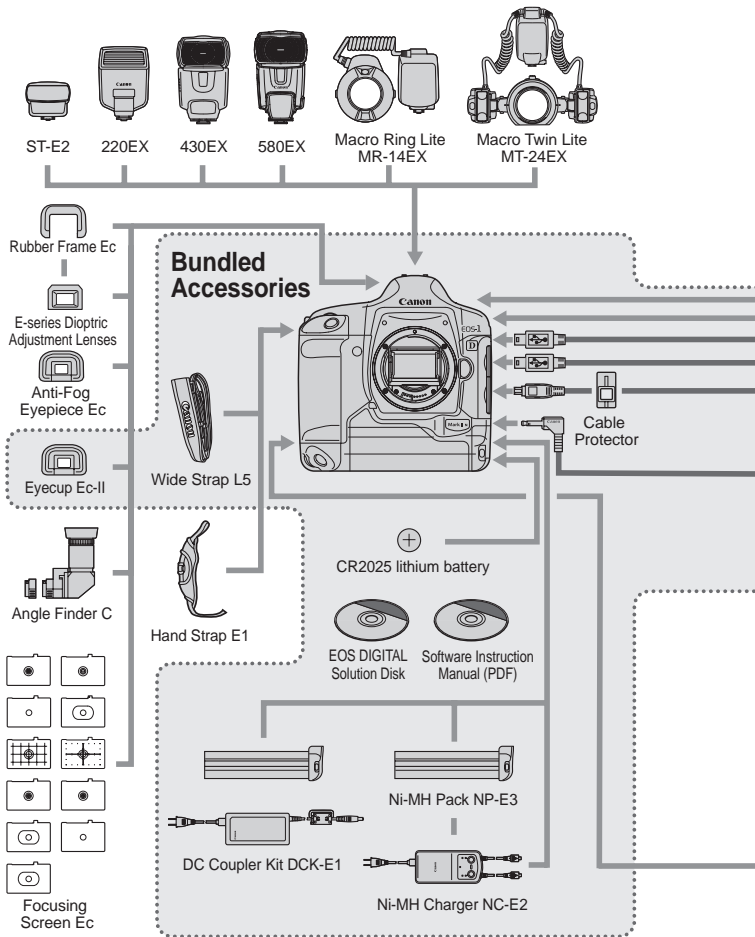



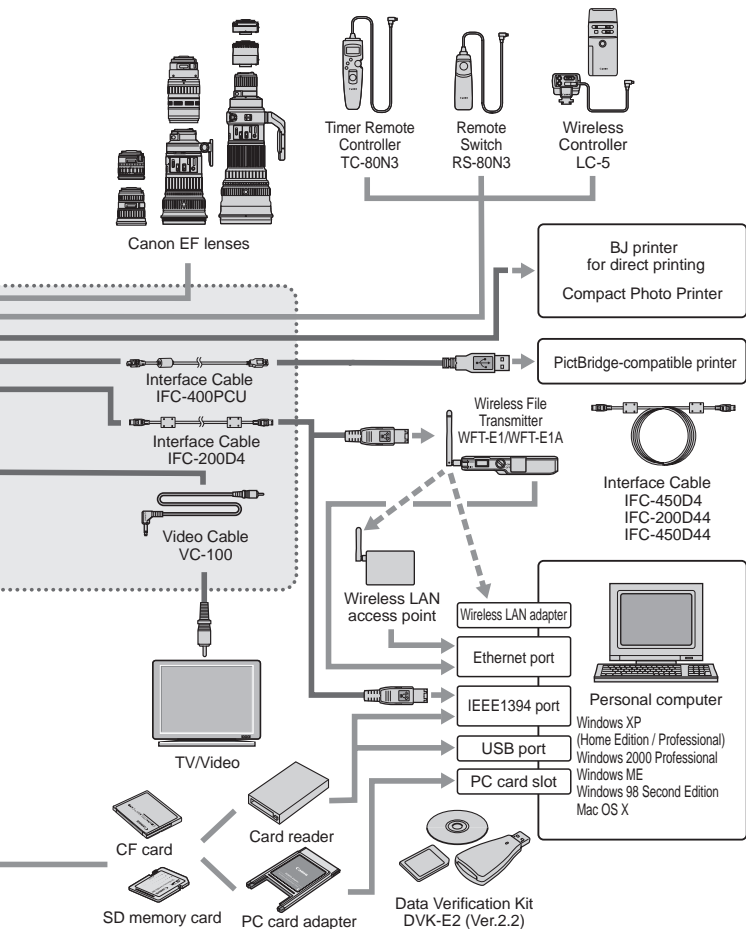

# Specifications

## • Type

Type:	Digital AF/AE SLR
Recording medium:	Type I or II CF card, SD memory card
Image sensor size:	28.7 x 19.1mm
Compatible lenses:	Canon EF lenses (except EF-S lens) (35mm-equivalent focal length is equal to approx. 1.3 times the marked focal length. )
Lens mount:	Canon EF mount

## • Imaging Element

Type:	High-sensitivity, high-resolution, large single-plate CMOS sensor
Pixels:	Effective pixels: Approx. 8.20 megapixels Total pixels: Approx. 8.50 megapixels
Aspect ratio:	3:2
Color filter system:	RGB primary color filter
Low-pass filter:	Located in front of the image sensor, non-removable

## • Recording System

Recording format:	Design rule for Camera File System 2.0
Image type:	JPEG, RAW (12bit)
RAW+JPEG	
simultaneous recording:	Provided
File size:	(1) L (Large):           Approx. 3.2 MB (3504 x 2336 pixels) (2) M1 (Medium1):    Approx. 2.6 MB (3104 x 2072 pixels) (3) M2 (Medium2):    Approx. 1.9 MB (2544 x 1696 pixels) (4) S (Small):         Approx. 1.1 MB (1728 x 1152 pixels) (5) RAW:                Approx. 7.9 MB (3504 x 2336 pixels) * JPEG quality: 8, Picture Style: Standard, ISO 100 * Exact file sizes depend on the JPEG quality, subject, ISO speed, etc.
Folder setting:	Folder creation/selection enabled
File name:	Preset camera code, user setting file name
File numbering:	Consecutive numbering, auto reset, manual reset
Color space:	sRGB, Adobe RGB
Picture Style:	Standard, Portrait, Landscape, Neutral, Faithful, Monochrome, User Def. 1- 3
Backup:	(1) Dual writing of identical images to CF card and SD card (2) Simultaneously-recorded RAW and JPEG images saved separately to CF card and SD card * Option (2) is possible only in the RAW+JPEG simultaneous recording mode.

Interface:	IEEE1394 terminal for personal computers USB terminal for direct printing Video output terminal (NTSC/PAL)
<b>• White Balance</b>	
Settings:	Auto, daylight, shade, cloudy, tungsten light, white fluorescent light, flash, custom, color temperature setting, Personal white balance (Total 10 settings)
Auto white balance:	Auto white balance with the image sensor
Color temperature compensation:	White balance correction: $\pm 9$ stops in full-stop increments White balance bracketing: $\pm 3$ stops in full-stop increments * Blue/amber bias or magenta/green bias possible
Color temperature information transmission:	Provided
<b>• Viewfinder</b>	
Type:	Eye-level pentaprism
Coverage:	Approx. 100 percent vertically and horizontally with respect to the effective pixels
Magnification:	0.72x (-1 diopter with 50mm lens at infinity)
Eyepoint:	20 mm
Built-in dioptic adjustment:	-3.0 - +1.0 diopter
Focusing screen:	Interchangeable (10 types optional), Standard focusing screen: Ec-CIII
Mirror:	Quick-return half mirror (Transmission:reflection ratio of 37:63, no mirror cut-off with EF1200mm f/5.6L USM or shorter lens)
Viewfinder information:	AF information (AF points, focus confirmation light), exposure information (shutter speed, aperture, manual exposure, spot metering circle, ISO speed, exposure level, exposure warning), flash information (flash ready, FP flash, FE lock, flash exposure level), white balance correction, JPEG recording, number of remaining shots, memory card information
Depth-of-field preview:	Enabled with depth-of-field preview button
Eyepiece shutter:	Built-in
<b>• Autofocus</b>	
Type:	TTL-AREA-SIR with a CMOS sensor

AF points:	45 AF points (Area AF)
Metering range:	EV 0-18 (at 20°C, ISO 100)
Focusing modes:	One-Shot AF (ONE SHOT) AI Servo AF (AI SERVO) Manual focusing (MF)
AF point selection:	Automatic selection, manual selection, home position (switch to registered AF point)
Selected AF point display:	Superimposed in viewfinder and indicated on LCD panel
AF-assist beam:	Emitted by the dedicated external Speedlite
<b>• Exposure Control</b>	
Metering modes:	21-zone TTL full aperture metering (1) Evaluative metering (linkable to any AF point) (2) Partial metering (approx. 13.5% of viewfinder at center) (3) Spot metering <ul style="list-style-type: none"><li>• Center spot metering (approx. 3.8% of viewfinder at center)</li><li>• AF point-linked spot metering (approx. 3.8% of viewfinder)</li><li>• Multi-spot metering (Max. 8 spot metering entries)</li></ul>
Metering range:	EV 0-20 (at 20°C with EF50mm f/1.4 lens, ISO 100)
Exposure control:	Program AE (shiftable), shutter-priority AE, aperture-priority AE, E-TTL II autoflash, manual, flash metered manual
ISO speed:	Equivalent to ISO 100-1600 (in 1/3-stop increments), ISO speed can be expanded to ISO 50 and 3200
Exposure compensation:	Manual: ±3 stops in 1/3- or 1/2-stop increments (can be combined with AEB) AEB: ±3 stops in 1/3- or 1/2-stop increments. (Bracketing methods: 1. Shutter speed or aperture 2. ISO speed)
AE lock:	Auto: Applied in One-Shot AF mode with evaluative metering when focus is achieved. Manual: By AE lock button in all metering modes.

### • Shutter

Type:	Electronically-controlled, focal-plane shutter
Shutter speeds:	1/8000 to 30 sec. (1/3- and 1/2-stop increments), bulb, X-sync at 1/250 sec.
Shutter release:	Soft-touch electromagnetic release

Self-timer:	10-sec. or 2-sec. delay
Remote control:	Remote control with N3 type terminal

### • Flash

EOS-dedicated Speedlite:	E-TTL II autoflash with EX-series Speedlite
Flash exposure compensation:	±3 stops in 1/3- or 1/2-stop increments
FE lock:	Provided
PC terminal:	Provided
Zooming to match lens focal length:	Provided

### • Drive System

Drive modes:	Single, low-speed continuous, high-speed continuous, self-timer
Continuous shooting speed:	High-speed continuous: Approx. 8.5 shots/sec. , Low-speed continuous: Approx. 3 shots/sec.
Max. burst:	JPEG: Approx. 48 shots (Large, JPEG 8), RAW: Approx. 22 shots

### • LCD Monitor

Type:	TFT color liquid-crystal monitor
Monitor size:	2.5 inch
Pixels:	Approx. 230,000
Coverage:	100% with respect to the effective pixels
Brightness adjustment:	Five levels provided
Interface languages:	15

### • Image Playback

Image display format:	Single image, single image (INFO.), 4-image index, 9-image index, magnified zoom (approx. 1.5x - 10x), rotated image
Highlight warning:	In the single image and single image (INFO.) formats, any overexposed highlight areas will blink in the image display.

### • Image Protection and Erase

Protect:	Erase protection of one image, all images in a folder, or all images in the memory card can be applied or canceled at one time.
Erase:	One image, all images in a folder, or all images in the memory card can be erased (except protected images) at one time.

### • Sound Recording

Recording method: The voice annotation recorded with the built-in microphone is attached to the image.

File type: WAV

Recording time: Max. 30 sec. per recording

### • Direct Printing

Compatible printers: CP Direct, Bubble Jet Direct, and PictBridge-compatible printers

Printable images: JPEG image compliant to Design rule for Camera File System (DPOF printing possible)

### • DPOF: Digital Print Order Format

DPOF: Version 1.1 compatible

### • Customization

Custom Functions: 21 Custom Functions with 69 settings

Personal Functions: 27

Camera setting saving/reading: Possible

### • Power Source

Battery: One Ni-MH Pack NP-E3  
\* AC power can be supplied via the AC adapter and DC coupler.

Startup time: Approx. 0.2 sec.

Battery life: At 20°C: Approx. 1200 shots

At 0°C: Approx. 800 shots

\* The above figures apply when a fully-charged Ni-MH Pack NP-E3 is used.

Battery check: Automatic

Power saving: Provided. Power turns off after 1, 2, 4, 8, 15, or 30 min.

Back-up battery: One CR2025 lithium battery

### • Dimensions and Weight

Dimensions (W x H x D): 156 x 157.6 x 79.9 mm

Weight: 1225 g (body only. battery: 335 g)

### • Operation Environment

Working temperature range: 0°C- 45°C

Working humidity: 85% or less

### • Ni-MH Pack NP-E3

Model: Ni-MH pack for the EOS-1D series camera.

Rated voltage:	12 V
Charging time:	Approx. 120 minutes
Recharge capability:	Approx. 500 charging cycles or more
Dimensions (W x H x D):	68.4 x 36.4 x 127.3 mm
Weight:	335 g

#### • Ni-MH Charger NC-E2

Model:	Charger / Discharger for Ni-MH Pack NP-E3, or NP-E2 batteries
Rated input:	100 - 240 V AC 50/60 Hz
Rated output:	14.5 V DC, 850 mA
Cord length:	2 m; Charging / discharging plug cord: 0.5 m
Charging time (for 1 pack):	Approx. 120 minutes for NP-E3 and approx. 100 minutes for NP-E2.
Discharging time:	Approx. 8.5 hours for a fully charged battery
Working temperature range:	0°C - 40°C
Dimensions (W x H x D):	82 x 49 x 167 mm
Weight:	380 g (excluding power cord)

#### • DC Coupler Kit DCK-E1

##### [DC Coupler]

Compatible camera:	EOS-1D series camera
Rated input:	13 V DC
Rated output:	13 V DC
Working temperature range:	0°C - 40°C
Working humidity:	20% - 85%
Dimensions (W x H x D):	127.3 x 36.4 x 68.4 mm
Weight:	130 g

##### [AC Adapter]

Power cord length:	2 m
DC adapter:	Approx. 1.4 m
Rated input/frequency:	100 - 240 V AC 50/60 Hz
Rated output:	13 V DC, max. 1.8 A
Working temperature range:	0°C - 40°C
Working humidity:	20% - 85%
Dimensions (W x H x D):	58 x 118 x 25 mm
Weight:	225 g (excluding power cord)

- All the specifications above are based on Canon's testing standards.
- The camera's specifications and physical appearance are subject to change without notice.



### Image Conversion Factor

Since the image area is smaller than the 35mm film format, it will look like the lens focal length is increased by 1.3x.

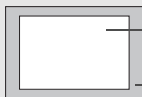

Image size  
28.7 x 19.1mm

35mm image size  
36 x 24mm



# Index

## A

Access lamp.....	32
Accessories.....	182
Adobe RGB.....	63
AE lock.....	109
AEB.....	107
AF mode.....	80
AF point activation area.....	86
AF point display.....	122
AF point registration/switching.....	84
AF point selection.....	82
AF point-linked spot metering.....	95
AI Servo AF.....	80
Aperture value.....	102
Auto bracketing sequence.....	164
Auto power off.....	45
Auto reset.....	76
Auto rotate.....	118
Automatic AF point selection.....	82
Av (Aperture-priority AE).....	102

## B

Backup.....	73
Battery.....	22, 25, 182
Battery check.....	25
Beeper.....	33
Bubble Jet Direct.....	146
Bulb exposures.....	110
Bundled Items.....	3

## C

Center-weighted averaged metering.....	95
Clear all camera settings.....	42
Clear all Custom Functions.....	160
Clear all Personal Functions.....	172
Color saturation.....	58
Color space.....	63
Color temperature.....	67
Color tone.....	58
Compression rate.....	54

Continuous numbering.....	77
Continuous shooting.....	91
Contrast.....	58
CP Direct.....	143
Custom Function group registration.....	170
Custom Functions.....	160
Custom white balance.....	65

## D

Date/time battery replacement.....	47
Date/time setting.....	46
DC Coupler Kit.....	27
Default settings.....	42
Depth of field.....	103
Design rule for Camera File System.....	2
Detail set.....	57
Dioptric adjustment.....	43
Direct Printing.....	135, 157
Discharge.....	23
DPOF.....	151
Drive modes.....	91
Dual image recording.....	73

## E

Enlarge display set.....	124
Erase.....	130
Error codes.....	179
E-TTL II autoflash.....	112
E-TTL II autoflash system.....	166
Evaluative metering.....	94
Exposure compensation.....	106, 112
Exposure level increments.....	162
EX-series Speedlite.....	112
Extension.....	52
Eyepiece shutter.....	111

## F

Faithful.....	56
FE lock.....	112
FEB.....	112

File name .....	75
File numbering .....	76
Filter effects .....	60
Firmware .....	41
Flash .....	112
Flash exposure compensation .....	112
Flash-sync contacts .....	15
Focus confirmation light .....	19
Focus lock .....	81
Focus mode switch .....	80, 89
Focusing screen .....	169, 180
Folder creation .....	71
Folder selecting .....	72
Format .....	133
FP Flash .....	112

**H**

Hand strap .....	50
Highlight alert .....	122
High-speed sync .....	112
Histogram .....	123
Holding the camera .....	43
Household power outlet .....	27

**I**

Image review .....	116
Image review time .....	117
Image size .....	52, 192
Image-recording quality .....	52
Index display .....	121
Interface cable .....	3
ISO speed .....	55
ISO speed extension .....	55

**J**

JPEG .....	52, 54
JPEG Quality .....	54

**L**

Landscape .....	56
Language .....	44

LCD monitor .....	11, 42
LCD panel .....	11, 17, 18
LCD panel illumination .....	110
Lens .....	11, 29
Low-level formatting .....	134

**M**

M (Manual exposure) .....	104
Magnified view .....	124
Main Dial .....	20, 35
Manual AF point selection .....	82
Manual focusing .....	89, 90
Manual reset .....	77
Maximum burst .....	53
Memory card .....	11, 30, 72, 183
Memory card formatting .....	133
Memory card selecting .....	72
Menus .....	38, 40, 41
Metering mode .....	94
MF .....	90
Mirror lockup .....	111
Monochrome .....	57
Multi-spot metering .....	96

**N**

Neutral .....	56
Noise reduction .....	78
Noise reduction of long exposures .....	78
Nomenclature .....	14
NTSC .....	126
Number of copies .....	141, 144, 147

**O**

One-Shot AF .....	80
-------------------	----

**P**

P (Program AE) .....	98
PAL .....	126
Paper settings .....	139
Partial metering .....	94
PC terminal .....	15

- Personal Functions ..... 171  
 PictBridge..... 139  
 Picture Style.....56, 58, 61  
 Playback ..... 120  
 Playback menu .....38, 40  
 Portrait .....56  
 Power switch.....33  
 Pressing completely.....34  
 Pressing halfway.....34  
 Print order ..... 151  
 Program AE .....98  
 Program shift.....99  
 Protect..... 127  
 PTP ..... 138
- Q**
- Quick control dial .....20, 36
- R**
- RAW.....52, 53  
 RAW+JPEG  
 simultaneous recording.....52  
 RAW+JPEG separate recording .....74  
 Recharge .....22  
 Remote control.....15, 183  
 Rotate image..... 118, 125
- S**
- Safety shift ..... 167  
 Saving/reading camera settings.... 173  
 Self-timer.....92  
 Sensor cleaning .....48  
 Set-up menu ..... 38, 41  
 Sharpness.....58  
 Shooting information ..... 122  
 Shooting menu.....38, 40  
 Shooting mode..... 17  
 Shots remaining .....26, 53  
 Shutter button .....34  
 Shutter curtain synchronization..... 167  
 Shutter release without card..... 161  
 Shutter speed..... 100  
 Single image display ..... 121  
 Single shooting..... 91  
 Sound recording ..... 129  
 Specifications ..... 186  
 Spot metering ..... 94  
 sRGB..... 63  
 Standard ..... 56  
 Strap ..... 50  
 Style..... 143, 146  
 System map ..... 184
- T**
- Timer ..... 20  
 Toning effect..... 60  
 Trimming ..... 149  
 Tv (Shutter-priority AE)..... 100
- U**
- User Defined ..... 57
- V**
- Vertical shooting ..... 37  
 Video cable..... 3, 126  
 Video OUT..... 126  
 Viewfinder..... 19
- W**
- White balance..... 64  
 White balance bracketing ..... 69  
 White balance correction..... 68  
 Wireless, multi-Speedlite system.. 112

# Canon

CANON INC.

30-2 Shimomaruko 3-chome, Ohta-ku, Tokyo 146-8501, Japan

*Europe, Africa & Middle East*

CANON EUROPA N.V.

PO Box 2262, 1180 EG Amstelveen, The Netherlands

CANON (UK) LTD

For technical support, please contact the Canon Help Desk:

P.O. Box 431, Wallington, Surrey, SM6 0XU, UK

Tel: (08705) 143723 (Calls may be recorded)

Fax: (08705) 143340

For sales enquiries, please call on (0121) 666-6262

CANON COMMUNICATION & IMAGE FRANCE S.A.

102 Avenue du Général de Gaulle,

92257 LA GARENNE COLOMBES CEDEX, France

Tel : Hot line 08 25 00 29 23

<http://www.cci.canon.fr>

CANON DEUTSCHLAND GmbH

Postfach 100401, 47704 Krefeld, Germany

Canon Hotline Service: 0180/5006022 (0,12 € / Min.)

[www.canon.de](http://www.canon.de)

CANON ITALIA S.P.A.

Via Milano 8, I-20097 San Donato Milanese (MI), Italy

Tel: 02/8248.1

Fax: 02/8248.4604

Pronto Canon: 02/8249.2000

E-mail: [supporto@canon.it](mailto:supporto@canon.it)

<http://www.canon.it>

CANON ESPAÑA S.A.

C/Joaquín Costa, 41 – 28002 Madrid, Spain

Tel. Atención al Cliente: 901.301.301

Help Desk: 807.117.255

<http://www.canon.es>

CANON BELGIUM N.V. / S.A.

Bessenveldstraat 7, B – 1831 Diegem, Belgium

Tel.: (02) 722.04.11

Fax: (02) 721.32.74

Helpdesk: 0900-10627

<http://www.canon.be>

CANON LUXEMBOURG S.A.

Rue des Jons 21, L-1818 Howald, Luxembourg

Tel.: (0352) 48 47 961

Fax: (0352) 48 47 96232

Helpdesk: 900-74100

<http://www.canon.lu>

CANON NEDERLAND N.V.

Neptunusstraat 1, 2132 JA Hoofddorp, The Netherlands

Tel.: 023 – 5 670 123

Fax: 023 – 5 670 124

Helpdesk: 023 – 5 681 681

<http://www.canon.nl>

CANON DANMARK A/S

Knud Højgaard's Vej 1, DK-2860 Søborg, Denmark

Tlf: 70 15 50 05

Fax: 44 88 22 99

[www.canon.dk](http://www.canon.dk)

CANON NORGE as

Hallagerbakken 110, Postboks 33, Holmlia, 1201 Oslo, Norway

Tlf: 22 62 93 21

Faks: 22 62 06 15

E-mail: [helpdesk@canon.no](mailto:helpdesk@canon.no)

<http://www.canon.no>

*Finland*

CANON OY

Kuluttajatuotteet, Huopalahdentie 24, PL1, 00351 Helsinki, Finland

Helpdesk: 020 366 466 (pvm)

Internet: [www.canon.fi](http://www.canon.fi)

CANON SVENSKA AB

Gustav III:s Boulevard 26, S-169 88 Solna, Sweden

Helpdesk: 08-744 8620

Fax 08-744 8527

<http://www.canon.se>

CANON (SCHWEIZ) AG

Industriestrasse 12, 8305 Dietlikon, Switzerland

Consumer Imaging Group

Tel. 01-835-61 61

Hotline 0900 57 55 20 (CHF 2.13/min)

<http://www.canon.ch>

*Austria*

CANON GES.M.B.H.

Zetschegasse 11, A – 1230 Wien, Austria

Helpdesk Tel.: 01 66 146 412

Fax: 01 66 146 413

<http://www.canon.at>

*Portugal*

SEQUE – SOC. NAC. EQUIP., S.A.

Pr. Alegria, 58 – 2ºC, 1269-149 Lisboa, Portugal

Tel: +351213242830

Fax: +351213472751

E-mail: [info@seque.pt](mailto:info@seque.pt)

<http://www.seque.pt>

This Instruction Manual booklet is current as of August 2005. For information on the camera's compatibility with any accessories and lenses introduced after this date, contact any Canon Service Center.